



SmartZone™ Network-Enabled M Series Rack PDU

User Manual

**Release 1.0
Issue 1.0**

Copyright © 2016 Panduit Corp. All rights reserved. No part of this book shall be reproduced, stored in a retrieval system, or transmitted by any means, electronic, mechanical, photocopying, recording or otherwise, without written permission from Panduit. No patent liability is assumed with respect to the use of the information contained herein.

Although every precaution has been taken in the preparation of this book, Panduit assumes no responsibility for errors or omissions. Neither is any liability assumed for damages resulting from the use of the information contained herein.

Table of Contents

SmartZone™ Network-Enabled M Series Rack PDU	5
Contacting Panduit	5
Symbols Used	5
Equipment Overview	7
Voltage and Current Values	7
Model Numbering Format	7
Model Numbers	8
Additional Model Numbers and Numbering Format	9
Pre-Installation	11
Product Inspection	11
Installation	12
Before You Begin	12
Standard Accessories	12
Mounting Hardware:	12
Cables/Adapters:	12
Hardwire PDU installation instructions	12
Unterminated Cord PDU installation instructions	14
Optional Accessories	15
SmartZone Environmental Sensors:	15
Additional Required Items	15
Safety Precautions	15
Servicing	15
Product Safety Warnings	15
Rules	16
Environmental Specifications	17
Bonding	17
Mounting	18
Vertical Mounting	18
PDU Bracket for 4-Post Racks	20
PDU Bracket for 2-Post Racks	21
Horizontal Mounting	22
Hardware	23
LCD Display	23
Reset Button	23
Mode Button Operation	24
Bootloader Startup	24
Firmware Recovery Mode	24
Application Startup	24
Internal Error Notification	25

Graphical User Interface	26
Access the PDU Graphical User Interface	26
Setup	29
IP Config	29
IPv4 Address Configuration	30
The DHCP configuration (Dynamic Addressing provided by Infrastructure)	31
Static Configuration (Manual Addressing)	31
IPv6 Address Configuration	31
AutoConfig only (link local addressing)	31
Static configuration (manual addressing)	31
DHCPv6 configuration (dynamic addressing provided by infrastructure)	32
Accessing the appliance via a web browser using IPv6	32
HTTP	32
SNMP NMS	33
SNMP Receivers	35
SNMP Trap Description Text Format	36
Users	37
Email Alerts	39
Time Settings	40
Time Adjustments	40
Syslog Servers	41
Events	42
Preferences	42
Restart	44
Input Sensors	45
Status	45
Defaults	46
Configure	51
Sensor Trap Text	52
Power	54
Status Single-Phase	54
Branch Monitoring	54
Status 3-Phase	55
Thresholds	55
Configure	56

SmartZone™ Network-Enabled M Series Rack PDU

Network-Enabled M (Monitored) Series Rack PDUs integrate with the Panduit PIM Software Platform and other SmartZone applications to enable intelligent management of in-cabinet power usage. This system helps to quickly identify potential power overload issues in order to aid in resolution, identify underutilized power capacity for efficient deployment of network resources, and automate collection of real-time power information.



The M Series PDU monitors per-phase power, voltage and current, as well as per-branch current.





SmartZone™ Network-Enabled PDUs are available in a wide range of configurations and power connections and outlets and can be mounted vertically or horizontally.

Contacting Panduit

For Technical Support on PDU hardware and associated software, please contact Panduit Technical Support using one of the following methods:

1-866-721-5302 (toll-free)
 Monday-Friday, 7:30 am - 5:00 pm CST
systemsupport@panduit.com

Symbols Used

Symbol	Description
	Danger – Electric Shock Hazard
	Warning – Possible Safety Hazard
	Primary Earth Ground
	Secondary Earth Ground

Symbol	Description
	ON
O	OFF

Equipment Overview

The power inlet/cord(s) connects the PDU to the electrical power source. On metered PDUs, the LCD displays the current load for each input feed or electrical phase per input feed.

- One shielded RJ45 connector for Ethernet connection
- Two unshielded RJ45 connectors for SmartZone™ sensors (For a list of supported sensors, see "Optional Accessories".)

For IEC C-20 inlet PDUs, a customer-supplied cord is used for connection to the power source. The connection end to the PDU has an IEC C-19 plug for connection to the PDU. The opposite end of the cord shall have a plug suitable for connecting to the customer supplied receptacle. The cord and plug shall be rated for 20A in North America and 16A outside of North America. The connection to the PDU should be made prior to connecting to the power source.

Voltage and Current Values

Non-U.S./Canada		U.S./Canada	
Voltage	Current	Voltage	Current
240, 415	10, 13, 16, 20, 30, 32, 48, 63	120, 208	12, 16, 24, 40, 48

Model Numbering Format

This section describes the model numbering format used to identify equipment in the PDU series. PDU devices are numbering using one of the following formats:

- **P1N-ABCDEFGHJKLM**
- **Q1N-ABCDEFGHJKLM**

The P1N prefix indicates that the model is intended for horizontal mounting. The Q1N prefix indicates that the model is intended for vertical mounting. The remaining series of letters represent values as defined in the table below.

Letter	What It Represents
A	any numeral, 1-8, indicating the phase wiring for the output circuit breakers and receptacles
B	Any letter, A-F, indicating input cord configuration
CD*	Any numeral, 1-5, and any letter, A-Z, indicating input plug type and rated voltage
E	Any numeral, 1-7, indicating the number of output circuit breakers
F	Any letter, A-Z, indicating the type of overload protection provided for the outlets
GH	Any two numerals, 01-45, indicating the number of output receptacles provided
JK	The letter 'A' or 'B' followed by any letter, A-Z, indicating the type and quantity of output receptacles provided
L	Any numeral, 0-9, or any letter, A-Z, indicating the length of the power supply cord
M	Any numeral, 0-9, indicating the color of the enclosure

* Voltage and amperage ratings:

120V, single-phase, 10A, 12A, 15A, 16A, 20A, 24A or 30A

208V, single-phase, 10A, 12A, 13A, 15A, 16A, 20A, 24A, 30A, 48A or 60A

230V, single-phase, 16A, 32A, or 48A

208V, three-phase (delta), 16A, 20A, 24A, 30A, 40A, 48A, 50A or 60A, 3W + PE

208V, three-phase (wye), 16A, 20A, 24A, 30A, 48A or 60A, 3W + N + PE

400V, three-phase (wye), 16A, 20A, 24A, 30A, 32A, 48A or 60A, 3W + N + PE

Model Numbers

Part Number
P1N1B1C0A10AKA0
P1N1B1L2N08ATA0
P1N1B1M2M10AKA0
Q1N1A3W0A24AF00
Q1N1B1C0A24AKA0
Q1N1B1D0A24AKA0
Q1N1B1E0A30AHA0
Q1N1B1F0A30AHA0

Part Number
Q1N1B3H0A24AFA0
Q1N1B3H0A30AHA0
Q1N1B3H0A30AXA0
Q1N2B1J0A30AHA0
Q1N2B1L2N30AHA0
Q1N2B1M2M24AKA0
Q1N2B1N3N30AHA0
Q1N2B1P3N30AHA0
Q1N2B2C3N30AHA0
Q1N2B2P6M30AHA0
Q1N2B2Q0A30AHA0
Q1N2B2T6N30AHA0
Q1N2B2W6N30AHA0
Q1N2B2W6N30APA0
Q1N2B3J2M30AHA0
Q1N2B4E3N30AEA0

Additional Model Numbers and Numbering Format

In addition to the listings above, the model numbers listed below are also covered, based on the naming conventions explained in the table that follows.

Part Number
HQ-208V30A
HQ-240V16A
HT-208V30A
VQ-240V16A
VT-208V60A
VT-415V32A
VW-208V60A
VW-415V32A

The format used for these model numbers is: **AB-xxxVyyA**

Letter	What It Represents
A	H = Horizontal V = Vertical
B	Q = Monitored with Monitored Per Outlet (Network Connection) T = Monitored with Monitored & Switched Per Outlet (Network connection) W = Monitored with Switched Per Outlet (Network Connection)
xxxV	Any voltage from 100 - 415
yyA	Amps, from 10 - 80

Pre-Installation

The Rack PDU products covered by this guide are designed to be installed within EIA racks and cabinets. Use of this product in other applications is acceptable, but other precautions may be required to allow for specific installations not covered by this guideline.

Product Inspection

Inspect the product prior to installation. If the product has any visible signs of damage, please contact the supplier.

Installation

Before You Begin

Before installing your PDU, refer to the following lists to ensure that you have all the items shipped with the unit as well as all other items required for proper installation.

Standard Accessories

Mounting Hardware:

- Vertical models:
Affixed button mounts
- Horizontal models:
Appropriate local mounting brackets and screws

Cables/Adapters:

- RJ45 patch cord cable

Hardwire PDU installation instructions

This product is intended to be hardwired by the customer must be installed by a qualified electrician AND adhere to all national & local electrical codes.

1. To install, remove the (4) securing screws on the removable user panel.
2. Unscrew strain relief grommet cap (indicated below) and feed the power cable through the grommet cap & the input gland.

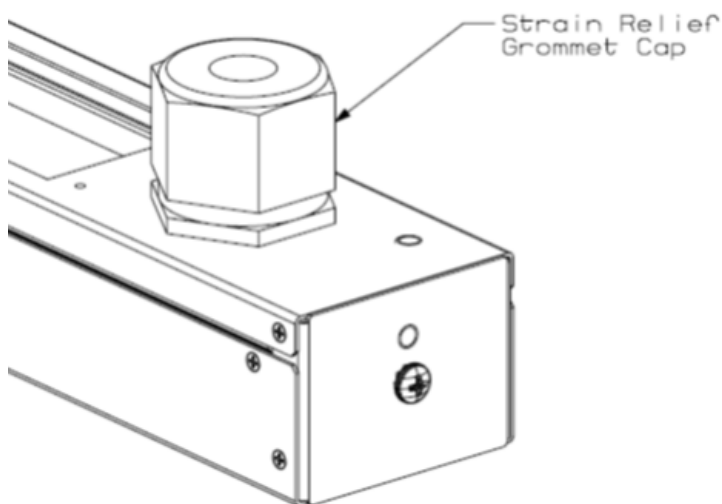

3. Ensure conductors are stripped adequately, exposing 15mm of copper.
4. Conductors shall be connected in-line with the terminal markings provided as shown below (Line 1 = X; Line 2 = Y; Line 3 – Z). Ensure screws are secure for each conductor by applying a torque of 2.3 N-m (20 in-lb.).

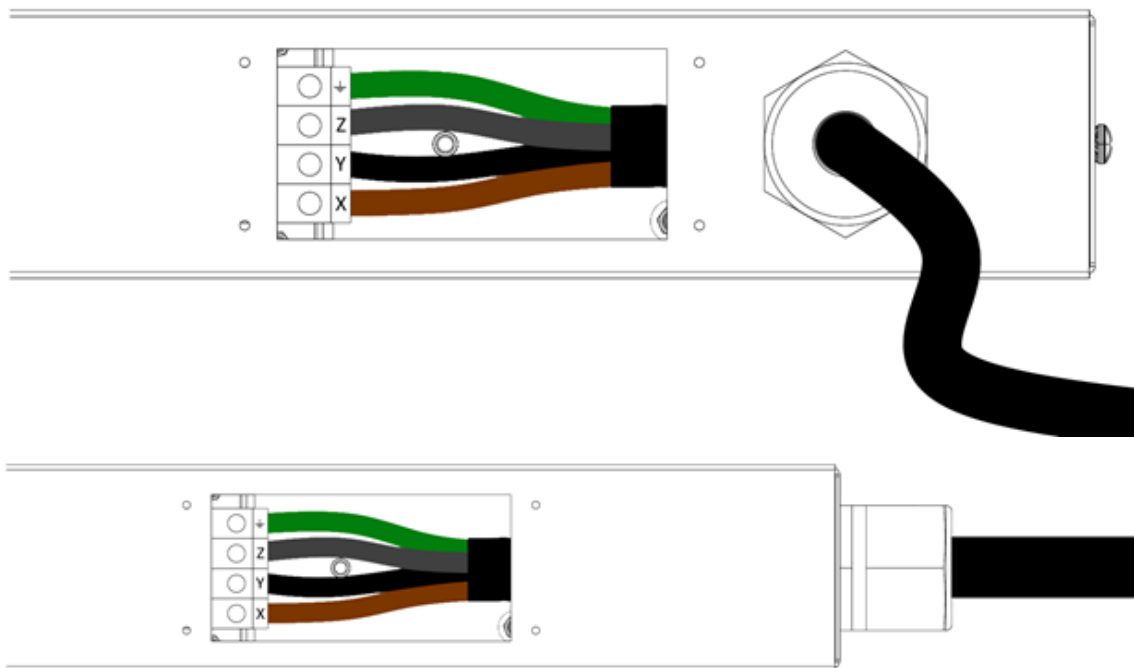

5. Ensure conductors have enough slack (none should be under tension).
6. Feed grommet cap down cord and secure to input gland. Reference the table below to ensure the grommet cap is torqued correctly.

Gland Size	Grommet Cap Torque
M16	1.5 N-m (13 in-lb.)
M20	3.0 N-m (27 in-lb.)
M25	4.0 N-m (35 in-lb.)
M32	
M40	15 N-m (132 in-lb.)
M50	20 N-m (177 in-lb.)
M63	30 N-m (266 in-lb.)

7. Re-install removable cover plate with the screws removed in step 1.
8. Connect the other end of the power cord to a suitably rated disconnect device.
9. Switch utility circuit breaker "On".

Unterminated Cord PDU installation instructions

This product is intended to be hardwired by the customer must be installed by a qualified electrician AND adhere to all national & local electrical codes.

To install, match the corresponding conductor color to the matching phase in your facility. Reference the color guide below:

Conductor Insulation Color	Line Number / Phase
Brown	Line1 / X
Black	Line 2 / Y
Grey	Line 3 / Z
Blue	Neutral
Green (may include Yellow stripe)	Ground

Optional Accessories

SmartZone Environmental Sensors:

- Smoke Sensor
- Humidity Sensor
- Water Rope Sensor
- Door Sensor
- Temperature Sensor
- Water Contact Sensor
- Air Flow Sensor
- Passive Infra-Red Motion Detector

Additional Required Items

- Flathead and Phillips screwdrivers
- Appropriate local AC power receptacle to power the PDU
- Local active Ethernet port to communicate with the PDU

Safety Precautions

This section contains important safety and regulatory information that should be reviewed before installing and using the Rack PDU.

Servicing

There are no user-serviceable parts inside these products. Any maintenance or repair must be performed by approved service-trained personnel. Opening the unit will void the product warranty.

Product Safety Warnings



Warning: Use only in dry locations. Indoor use only.

PDU hardware has an International Protection Rating of IPX0.

The installer must connect the power distribution unit to an electrical supply that has a protective Earth conductor.

For pluggable equipment, the socket outlet should be installed near the equipment and should be easily accessible.



Warning: For permanently connected equipment, a readily accessible disconnect device should be incorporated external to the equipment.

Power distribution products must be protected by a branch circuit protective device rated at the maximum rating of the product specified on the product rating label.

To avoid risk of overload, do not plug additional multiple outlet power distribution devices into the power distribution unit socket outlets.

This equipment is intended only for installation and use in a Service Access Location in accordance with the following installation and use instructions.

This equipment is designed to be installed on a dedicated circuit.

- The dedicated circuit must have circuit-breaker or fuse protection.
- Rack PDUs have been designed without a master circuit breaker or fuse to avoid becoming a single point of failure. It is the customer's responsibility to provide adequate protection for the dedicated power circuit. Protection of capacity equal to the current rating of the Rack PDU must be provided and must meet all applicable codes and regulations. In North America, protection must have a 10,000A interrupt capacity.



Warning: Always disconnect the power supply cord before opening to avoid electrical shock.



Danger Electric shock risk **DANGER:** High leakage current! Earth connection is essential before connecting supply!



Danger Electric shock risk **DANGER:** Double Pole/Neutral Fusing: The plug on the power supply cord must be installed near the equipment and must be easily accessible.

Rules

These limits are designed to provide reasonable protection against harmful interference when the equipment is operated in a commercial environment. This equipment generates, uses, and can radiate radio frequency energy and, if not installed and used in

accordance with the instruction manual, may cause harmful interference to radio communications. Operation of this equipment in a residential area is likely to cause harmful interference in which case the user will be required to correct the interference at his own expense.

Changes/modifications not approved by the responsible party could void the user's authority to operate the equipment.

Environmental Specifications

- Operating Temperature: 0C to 40C
- Transportation Temperature: -10C to 70C
- Operating Humidity: 15% to 85% non-condensing
- Transportation Humidity: 5% to 90% non-condensing

Bonding

This product contains an external earthing screw with a star washer, which should be used for supplementary Earth bonding to the rack metalwork.

Bonding	
Minimum Requirements for Bonding Conductors	
Up to and including 32A	12 AWG
Up to and including 63A	8 AWG
Up to and including 80A	6 AWG
Screw Size	
Over 16A, less than or equal to 40A	5mm
Over 40A, less than or equal to 63A	6mm
64A	7mm

Mounting

There are two mounting options for Rack RDUs

- Vertical Mounting
- Horizontal Mounting

Instructions for each mounting option are detailed below.

Vertical Mounting

The product is intended to be installed using the tool-less mounting buttons. These buttons locate in the fixing holes provided as shown in the following figure.

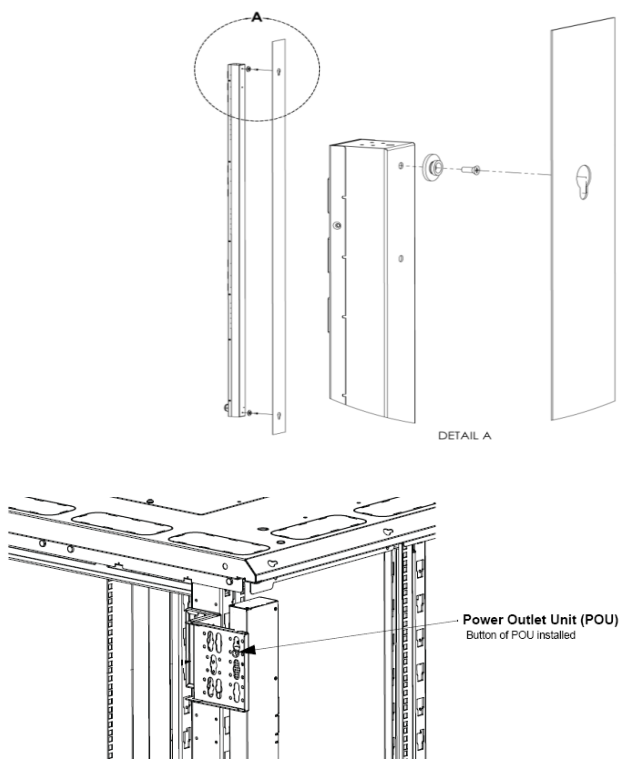

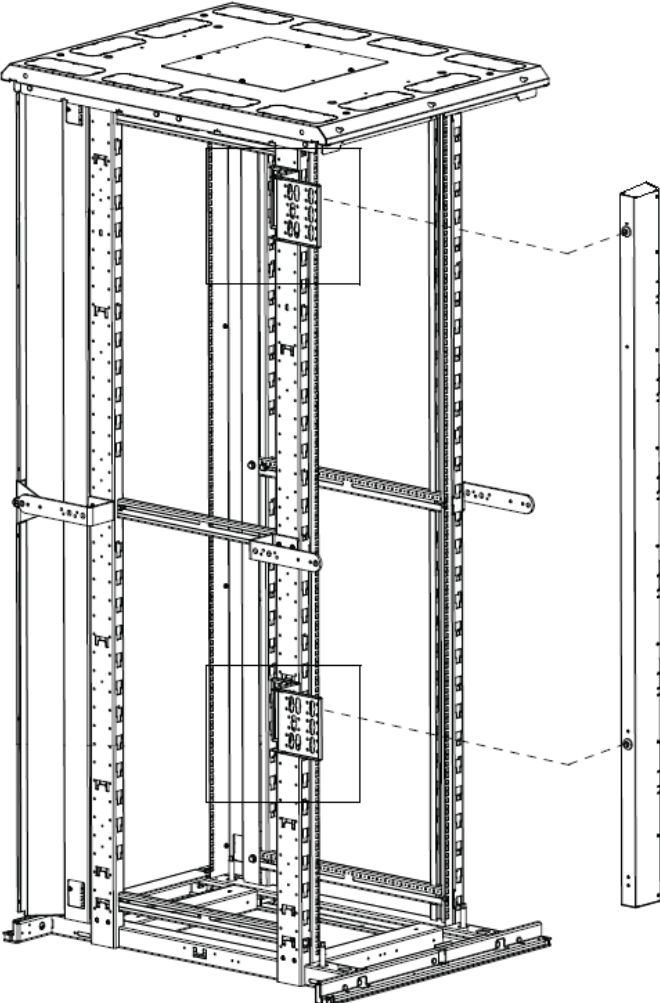

PDU Bracket for 4-Post Racks

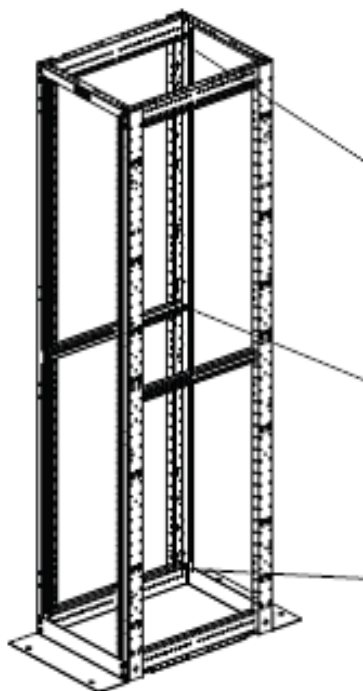

CVPDUB - Pair of Brackets for Vertical PDU Button Mounting to the side of the rack post.

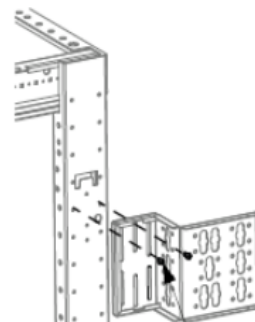
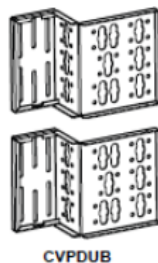

Align bracket to desired location on rack post, then secure with #12-24 screws.

PDU Bracket for 2-Post Racks

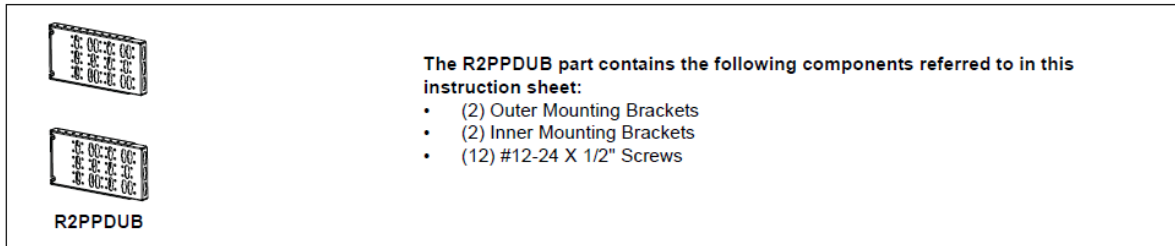

Installation Instructions-Outer Mounting Brackets

Attach (2) #12-24 X 1/2" screws to rack (per bracket) at appropriate locations.

Fasten outer mounting brackets to rack using the screws. The large flat surface with slotted holes may face outside or inside.

For mounting long (66.25") POU's, the brackets may be spaced vertically between 35 and 39 RU apart, in 1 RU increments, measured from bracket base to bracket base.

For mounting short (39") POU's, the brackets may be spaced vertically between 19 and 23 RU apart, in 1 RU increments, measured from bracket base to bracket base.

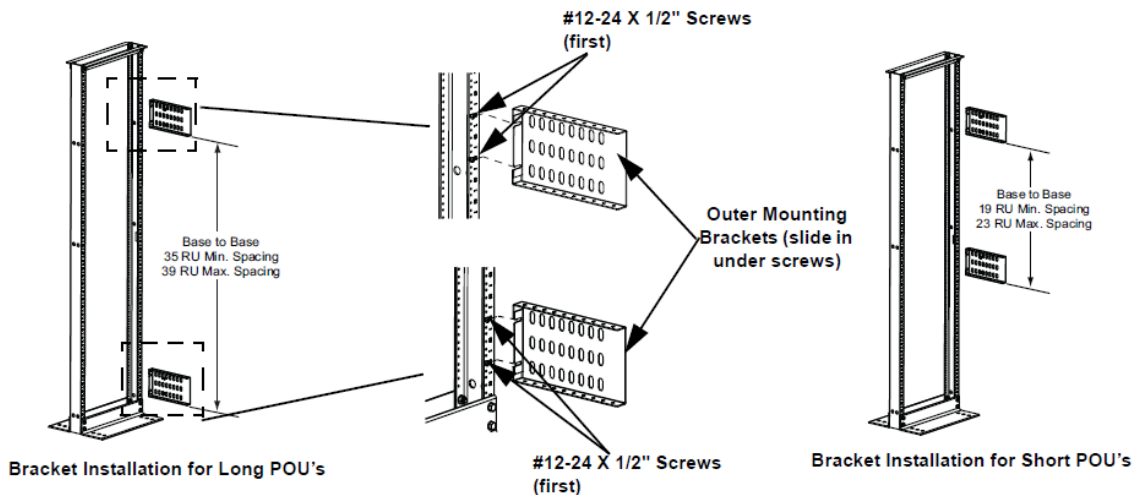

Installation Instructions-Inner Mounting Brackets

Slide inner mounting brackets into outer mounting brackets with the POU mounting keyway surface facing opposite the outer bracket slotted hole surface. Fasten brackets together using (4) #12-24 X 1/2" screws for each bracket set. (2) screws will be fastened on the top flange and (2) screws will be fastened on the bottom flange.

Important: (2) screws must be fastened in the most **outward** hole on each **outer** mounting bracket (1 top, 1 bottom). (2) screws must be fastened in the position where the hole in the **inner** mounting bracket is **closest** to the face of the rack, regardless of extended position.

Note: Multiple holes on the top and bottom of the brackets allow the distance from the rack a POU can be mounted to be adjustable. This means that the side facing POU can be mounted ranging from 3.7"-18.7" horizontally from the face of the rack. The rear facing POU can be mounted ranging from 12.3"-20.3" horizontally from the face of the rack.

Horizontal Mounting

This product is intended to be installed using the rack's RU mountings via the brackets found at either end of the PDU with the accessory screws provided listed below.

- Horizontal Models
North American units
(4) #10-32 x 1/2" MOUNTING SCREWS
(4) #12-24 x 1/2" MOUNTING SCREWS

- Global units
(4) M6 x 20mm MOUNTING SCREWS
(4) #12-24 x 1/2" MOUNTING SCREWS

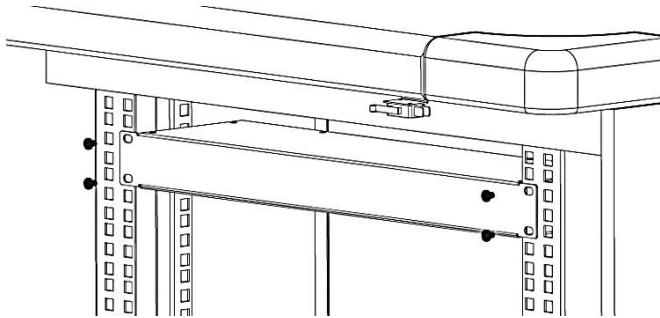

Hardware

LCD Display

The display shows the firmware version number, device model number, serial number, MAC Address, IP Address, and electrical readings. The display automatically scrolls through the readings. Readings that can be displayed include:

- Start Up messages
- Configuration/serial/product number messages
- Error/Status messages
- Aggregate data
- Single phase data, 3 Phase Delta data, or 3 Phase Wye data
- Branch current data, if the unit has breakers

During normal operation, the mode button may be used to quickly advance through the LCD display pages.

Reset Button

Push the **Reset** button using a non-metallic item, similar in size to a paper clip, to reset the PDU device.



Warning: a metallic item, such as a paper clip, is not recommended as a reset tool.

The reset tool should be inserted perpendicular to the surface of the device and pressed until the button is reached and is actuated.

The reset tool should bump into the button within 1/8 of an inch of being inserted, and should be lightly depressed and held for at least 1 second. The reset tool should never be inserted more than 1/4 of an inch.

Resetting the PDU device starts the bootloader.

For PDUs with bootloader versions 2.3.03 and 2.3.04: Wait between 1 and 30 seconds for the Display Backlight to blink on and off at a rate of 2 blinks per second. The bootloader stays in this mode for at least 4 seconds (8 blinks) if no user operation is detected.

For PDUs with bootloader versions 2.3.05: Wait between 1 and 30 seconds for the Display Backlight to blink on and off at a rate of 4 blinks per second. The bootloader stays in this mode for at least 2 seconds (8 blinks) if no user operation is detected.

Mode Button Operation

Bootloader Startup

When the user presses and holds the **Mode** button, the Display Backlight switches to one blink per second, indicating the bootloader is waiting for one of the following operations.

- If the user releases the **Mode** button after two blinks, the backlight goes solid-on and stays in the bootloader, entering the “firmware recovery mode”. See the “Firmware Recovery Mode” section (below) for more details.
- If the user releases the **Mode** button after four blinks, the backlight goes solid-on and attempts to boot the “backup firmware image”.
- If the user does not operate the **Mode** button as described above, the Display Backlight is turned off. The “firmware updatable application image” continues loading.

Firmware Recovery Mode

The Network-Enabled PDU provides a firmware recovery mode in case a firmware update is interrupted while in progress and fails to complete successfully.

Note: Do not power cycle or restart a device while a firmware update is in progress.

If a firmware update does not complete successfully, and the device fails to be operational after 30 minutes, contact Panduit Technical Support.

1-866-721-5302 (toll-free)

Monday-Friday, 7:30 am - 5:00 pm CST

systemsupport@panduit.com

Application Startup

When the application is ready, a message is displayed on the LCD:

```
Starting up...
```

The display backlight blinks quickly three times and remains lit.

The LCD then displays:

Hold MODE button to reset to defaults...

The application stays in this mode for at least 5 seconds. If no button operation is detected, the application continues to normal system operation.

If the customer presses and holds the **Mode** button for 5 seconds, the following message displays on the LCD:

```
Hold MODE button more than 5 seconds to reset to defaults
```

If the customer continues to press and hold the **Mode** button, the following message displays on the LCD:

```
Reset to defaults is detected. Please release MODE button.
```

The customer should release the **Mode** button at this point. The following message displays on the LCD:

```
Device is Resetting to factory defaults.
```

If the customer does not operate the **Mode** button as described above, the application continues normal system operation.

Internal Error Notification

After system start up is complete, during normal operation of the unit, the LCD screen may blink. This typically indicates a temporary or persistent internal error condition.

If the condition is persistent, the LCD screen displays the word "STATUS:" followed by a hexadecimal code, similar to the following.

```
STATUS: 0x009000080
```

The hexadecimal code is a composition of per-outlet control, per-outlet monitoring and per-phase monitoring status. For example, if a three phase Per-outlet Monitoring or Switched unit loses a power phase, the status screen will reflect that communication to those boards has been lost.

For definitions and recommended actions on status codes, provide the displayed hexadecimal number to Panduit Technical Support.

Graphical User Interface

The Panduit Network Enabled Rack PDU provides access to configuration, power, and sensor data through a Graphical User Interface (GUI), using a standard browser. There are several ways to connect to the device's GUI, depending on your network configuration and the firmware revision of the device.

If the PDU has firmware revision 2.3.03 (or earlier), Static IP is the default. The configuration settings in this case are:

IPv4 Address:192.168.0.253

IPv4 Network:255.255.255.0

IPv4 Gateway:192.168.0.1

If the device has firmware revision 2.3.04 (or later), DHCP is the default, and one of the following scenarios will be used.

- If you have a DHCP Server available, connect to the appliance through that server, using the PDU's IP Address.

Note: The IP address for the Rack PDU is displayed on the device's LCD screen after the label IPv4

- If you do not have a DHCP server, you can run one on your PC. To connect to the device, use the IP address displayed on the LCD screen.
- If you want to use automatic IPv4 address configuration, you must activate DHCP on your PC and then connect directly to the PDU. This will give you an address on the 169.254.0.0/16 network. You can then connect directly using the IP Address displayed on the LCD screen.

Access the PDU Graphical User Interface

To access the GUI, open a web browser and enter the IP Address of the PDU. When the login page opens, you will be prompted to enter a Login and Password.

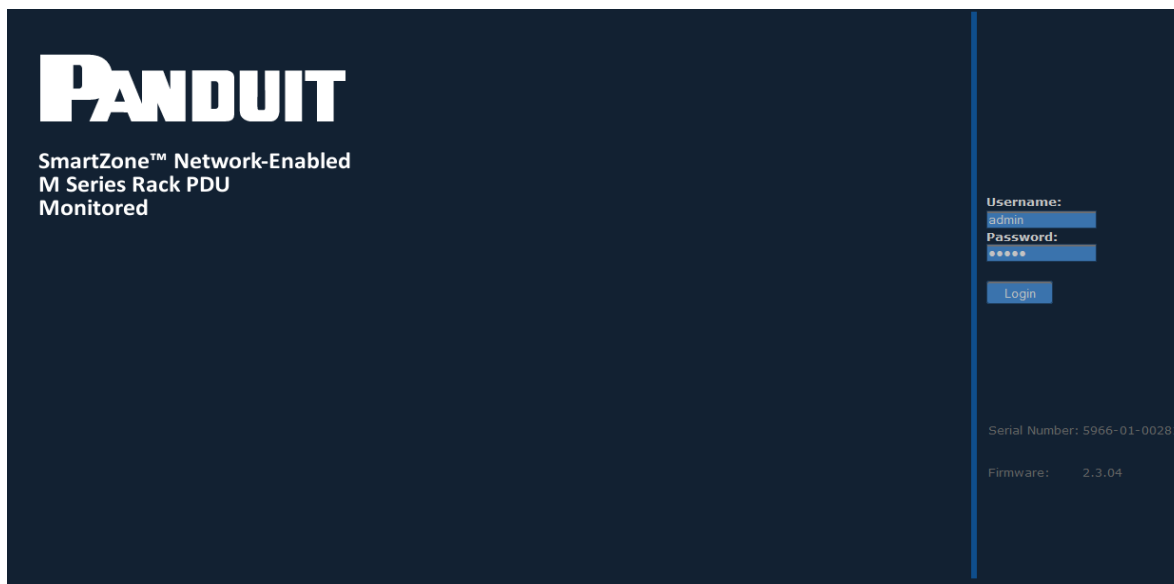

The default login and password are:

Login:admin

Password:admin

After successful login, the GUI opens to the Overview page.

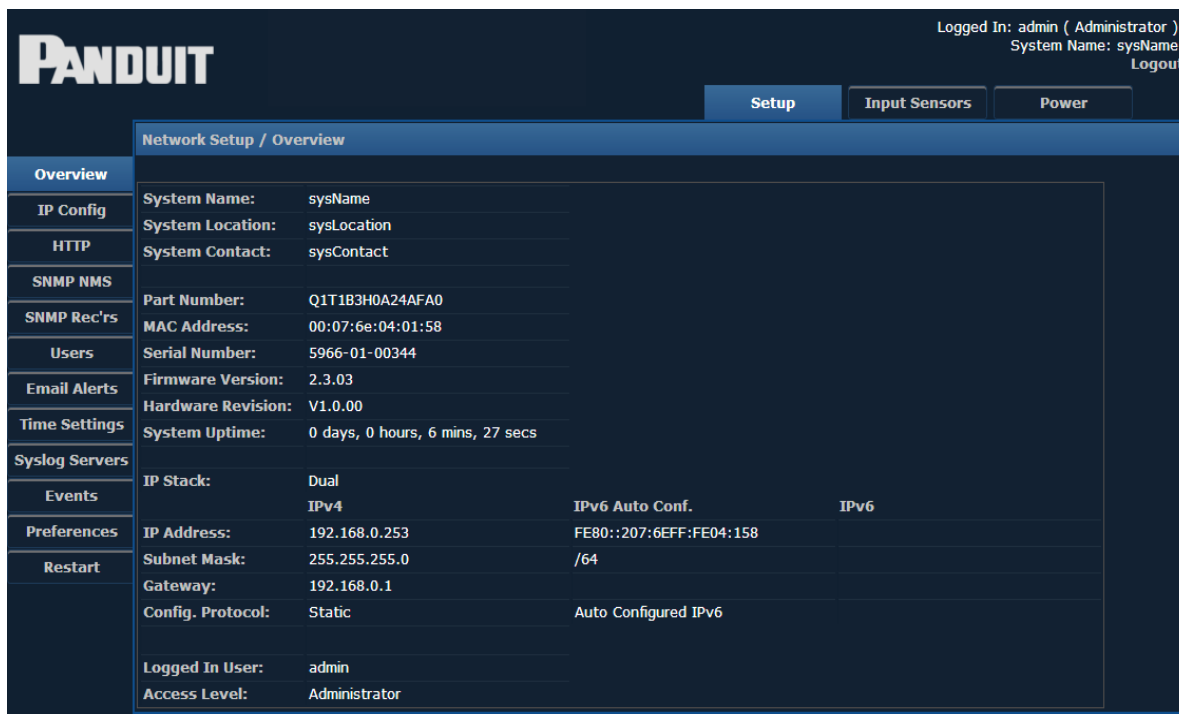

There are three modules within the GUI, each providing access to a different area within the PDU. The modules are:

- Set Up
- Input Sensors
- Power

To select a module, click the appropriate label along the top of the display.

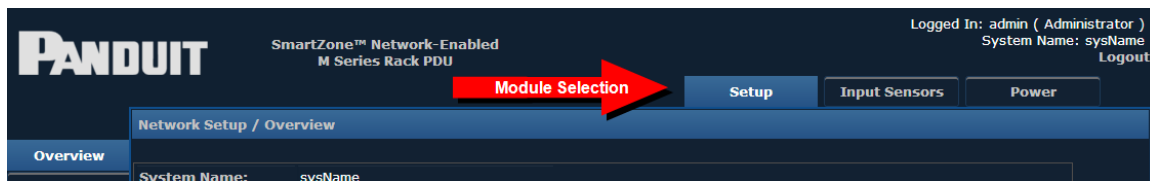

The menu items that appear on the left hand side of the screen will change depending on the module selected.

Setup

When the setup module is selected, the following menu items appear along the left hand side of the display.

Setup Menu Options	
IP Config	View or edit the network settings
HTTP	View or edit the HTTP settings
SNMP NMS	View or edit information about NMS access
SNMP Rec'rs	View or edit information about the SNMP Receivers
Users	View or edit information about all users
Email Alerts	View or edit email alert settings
Time Settings	View or edit information about the date and time
Syslog Servers	View or edit information about the Syslog servers
Events	View Event history
Preferences	View or edit system preferences
Restart	Provides the ability to restart the PDU

Detailed information on each of these menu items can be found in the corresponding sections below.

IP Config

Selecting this option displays the IP Configuration page, where network settings for the unit can be set. This is the information that will be displayed on the Overview page.

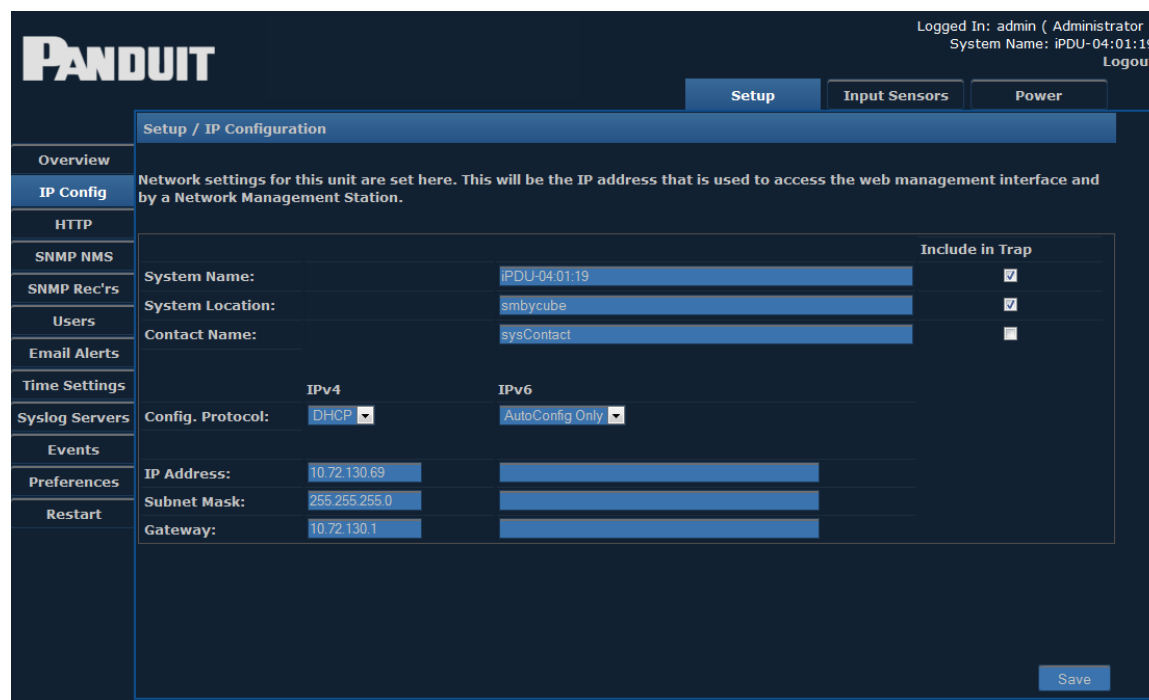

IP Configuration	
System Name	The name of the PDU
System Location	The location of the PDU
Contact Name	A person to contact regarding the PDU
Config Protocol	Select the configuration protocol
IP Address	The IP address of the PDU
Subnet Mask	The Subnet Mask for the PDU IP Address
Gateway	The Gateway for the PDU IP Address

IPv4 Address Configuration

There are several kinds of IPv4 address configurations that you can choose from. Static IPv4 is the default configuration for firmware releases before firmware version 2.3.04. DHCP is the default configuration for firmware releases after firmware releases 2.3.03.

The DHCP configuration (Dynamic Addressing provided by Infrastructure)

- The DHCPv4 client allows the user to obtain IPv4 configuration information from a DHCPv4 server. The functions that the DHCPv4 client performs include:
 - Basic server discovery and address assignment.
 - Address renewal and rebinding.
 - Address deprecation when the preferred lifetime expires.
 - Address removal when the valid lifetime expires.
 - Address release when the interface is closed.

Static Configuration (Manual Addressing)

- The customer must specify an IP address, Subnet mask, and Gateway.

IPv6 Address Configuration

There are several kinds of IPv6 address configuration that can be chosen.

AutoConfig only (link local addressing)

- IPv6 AutoConfig addressing is always available.
- The customer does not specify an IP Address, IPv6 prefix (shown as Subnet Mask in the web UI) or Gateway.
- The link local address is always based on the MAC Address converted into an EUI-64 address.

For example, the MAC Address: 00:07:6E:04:01:28 is always accessible at the IPv6 Link local address: FE80::0207:6EFF:FE04:0128.

Note that the first byte of the MAC address has 0x02 added to it where FF:FE is inserted into the middle of the MAC address bytes. The technical term for this address format is stateless address autoconfiguration (SLAAC) using the modified EUI-64 format.

Static configuration (manual addressing)

- The customer must specify an IP Address, IPv6 prefix (shown as Subnet Mask in the web UI) and Gateway.
- Static IPv6 configuration works concurrently with stateless address auto-configuration.

DHCPv6 configuration (dynamic addressing provided by infrastructure)

The DHCPv6 client allows the user to obtain IPv6 configuration information from a DHCPv6 server and works concurrently with stateless address autoconfiguration. The functions performed by the DHCPv6 client include:

- Basic server discovery and address assignment
- Address renewal and rebinding
- Address deprecation when the preferred lifetime expires
- Address removal when the valid lifetime expires
- Address release when the interface is closed

The current implementation of the DHCPv6 client has certain limitations. The following are the features that are currently not supported:

- Authentication
- RECONFIGURE Messages
- IA_TAs (Temporary Addresses)
- Rapid Commit FQDN (Fully Qualified Domain Name)
- DUID-LLT
- IA_PD (Identify Association for Prefix Delegation)

Accessing the appliance via a web browser using IPv6

A web browser can access IPv6 addressed devices using the full or short form IPv6 address.

For example, to access an appliance with the MAC address 00:07:6E:04:01:28, you could navigate to the AutoConfig address: [http://\[FE80::0207:6EFF:FE04:0128\]/](http://[FE80::0207:6EFF:FE04:0128]/) or [https://\[FE80::0207:6EFF:FE04:0128\]/](https://[FE80::0207:6EFF:FE04:0128]/) . The open and close square brackets indicate an IPv6 address.

When using a PC with more than one IPv6 enabled network interface (multi-homing), IPv6 scoped URLs may be necessary to access a device. Not all web browsers fully support IPv6 scoped URLs. Therefore, this problem must be worked around by enabling IPv6 on only one interface at a time on the computer running a web browser to access the appliance.

HTTP

This page allows you to choose the access method for the web management interface.

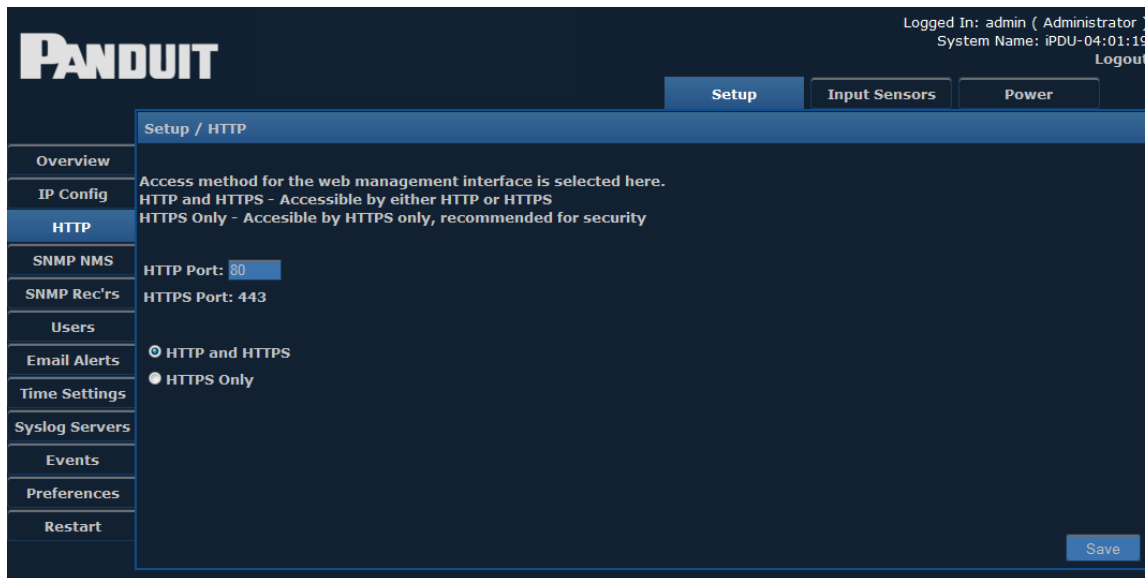

To choose the access method, click the corresponding radio button and enter the appropriate **Port** number. Typically the Port does not need to be changed from its default setting (80 for HTTP or 443 for HTTPS).

HTTP or HTTPS access methods can be used. However, HTTPS is recommended for security.

When you save any changes to this page, you will see the following message:

```
After Saving, would you like to restart the unit?
```

```
Click 'OK' to restart, otherwise 'Cancel'.
```

If you select **Cancel**, you are reminded that you will need to manually restart for any changes to take effect.

SNMP NMS

This page provides access for Network Management Stations.

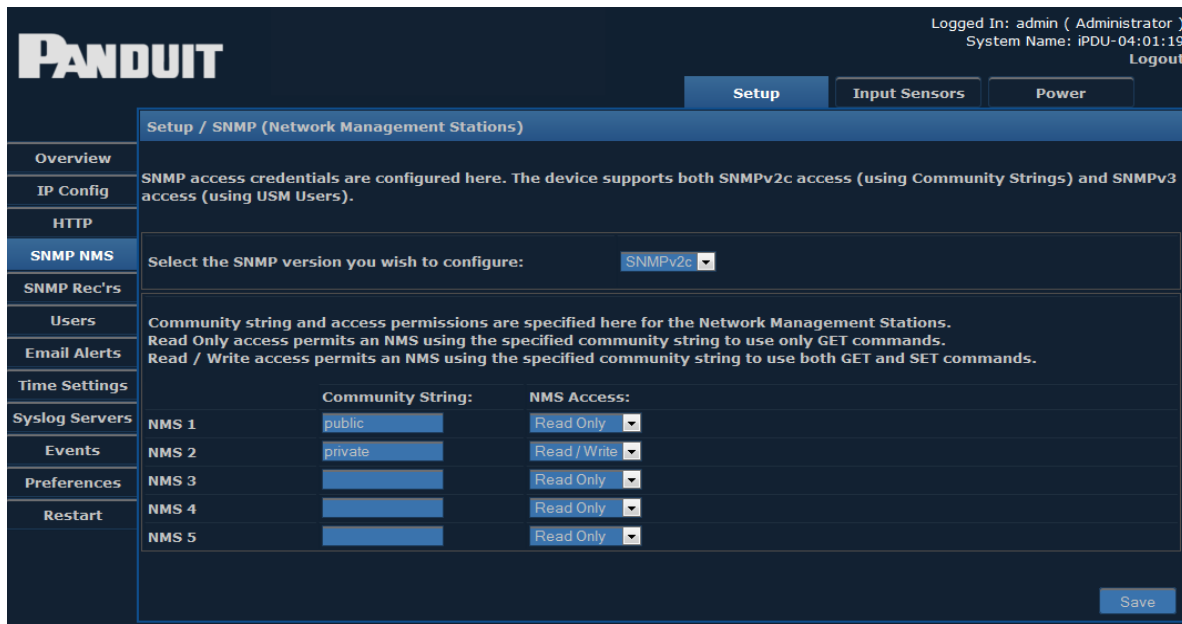

Both SNMPv2c and SNMPv3 protocols are supported simultaneously. You must enter the credential information for any device that needs to communicate with the unit via Simple Network Management Protocol (SNMP).

Select the SNMP version settings you wish to edit from the drop-down menu.

For ease of initial deployment and discovery, default credentials for both versions have been provided:

- The SNMPv2 default Community Strings are “public” (read-only access) and “private” (read/write access).
- The unit will respond to SNMPv3 requests using the MD5 authentication and DES privacy protocols. To use the "authUser" and "secureUser" user names, an Authentication and/or Privacy password must first be set.
- To disable a specific version of SNMP, simply remove the Community Strings (SNMPv2c) or User Names (SNMPv3) and save the configuration.

Enter the **Community String** for any device that must access the unit’s SNMP functions.

Access permissions can be selected from the drop-down menu under **NMS Access**.

Access Permission Settings	
Read Only	Permits the NMS to use only GET commands
Read / Write	Permits the NMS to use both GET and SET commands

SNMP Receivers

The **SNMP Receivers** page displays information for all devices that receive SNMP traps sent from this unit.

Logged In: admin (Administrator)
System Name: iPDU-04:01:19
Logout

Setup / SNMP (Receivers)

Overview: SNMP Trap Receivers are configured here. Any machine which will be required to receive SNMP traps sent from this unit must be entered here.

IP Config: Notes: Authentication failure traps, when enabled, are generated if an attempt is made to access the unit with an invalid community string.

HTTP: v3 Traps are sent in a snmpv2-trap format contained within a SNMPv3 message. Authentication or Encryption is not supported.

SNMP NMS: All Traps are generated to port 162.

Users	Receiver IP Address:	Receive Traps:	Trap Version:
Email Alerts	Receiver 1	Disabled	v1
Time Settings	Receiver 2	Disabled	v1
Syslog Servers	Receiver 3	Disabled	v1
Events	Receiver 4	Disabled	v1
Preferences	Receiver 5	Disabled	v1
Restart	Receiver 6	Disabled	v1
	Receiver 7	Disabled	v1
	Receiver 8	Disabled	v1
	Receiver 9	Disabled	v1
	Receiver 10	Disabled	v1

Test All Save

Enter the **IP address** and **Community String** for any device that will be required to receive SNMP traps. Usually any SNMP NMS entries should also be entered here. From the dropdown menu under **Receive Traps**, select one of the following:

Receive Traps Settings	
Disabled	Receiving traps is prohibited
Enabled	Allows the specified NMS to receive the unit's standard

Receive Traps Settings	
	range of traps
Enabled (Incl. Auth Fails)	Receive traps – causes the unit to issue traps if there is an unauthorized attempt to access the unit’s SNMP functions.

The version of trap/notification can be selected from the dropdown menu under **Trap Version**.

SNMP Trap Description Text Format

SNMP Traps are detected when certain events are detected. The format of the generated text messages is explained below.

NOTE: Before the text message is sent, all leading, trailing and repeated whitespace is removed.

The SNMP trap text format is:

```
<snmp-trap-format> ::= <opt-timestamp-prefix> " " <opt-system-name> " " <opt-system-location> " " <opt-contact-name> " " <trap-kind> " " <source-name> " " <chan-no> " " <user-text> " " <value> " " <data-type> " " <opt-timestamp-postfix>
```

The following table contains definitions for each parameter.

SNMP Trap Text Format	
<opt-system-name> ::= <text>	Optional. When Setup -> IP Config / System Name / Include In Trap is checked, Setup -> IP Config -> System Name is displayed.
<opt-system-location> ::= <text>	Optional. When Setup -> IP Config / System Location / Include In Trap is checked, Setup -> IP Config -> System Location is displayed.
<opt-contact-name> ::= <text>	Optional. When Setup -> IP Config / Contact Name / Include In Trap is checked, Setup -> IP Config -> Contact Name is displayed.
<opt-timestamp-prefix> ::= <text>	Optional date/time prefix. (When Setup / Preferences Timestamp Traps: is set to “Prefix”.)
<trap-kind> ::= <text>	Type of notification. Warning, Critical, Information

SNMP Trap Text Format	
	On, Information Off, Cleared, Unknown.
<source-name> ::= <text>	Data source. Example: "Input 01".
<chan-no> ::= "(" <number> ")"	When available, the number of the sensor Port the alert came from.
<user-text> ::= <text>	Event description of the reason for the trap. See the "User Text" strings on the Trap Configuration pages or the per-sensor configuration pages. Example: For contact sensors, the "Normal Trap User Text" or "Non-Normal Trap User Text" is used.
<value> ::= <text>	The value at which the event occurred. Example: "900" indicates 90% humidity.
<data-type> ::= <text>	Type of the data. Example: "relative humidity"
<opt-timestamp-postfix> ::= <text>	Optional date/time postfix. (When Setup / Preferences Timestamp Traps: is set to "Append".)

Users

Select the **Users** menu item to add or modify Web GUI User settings.

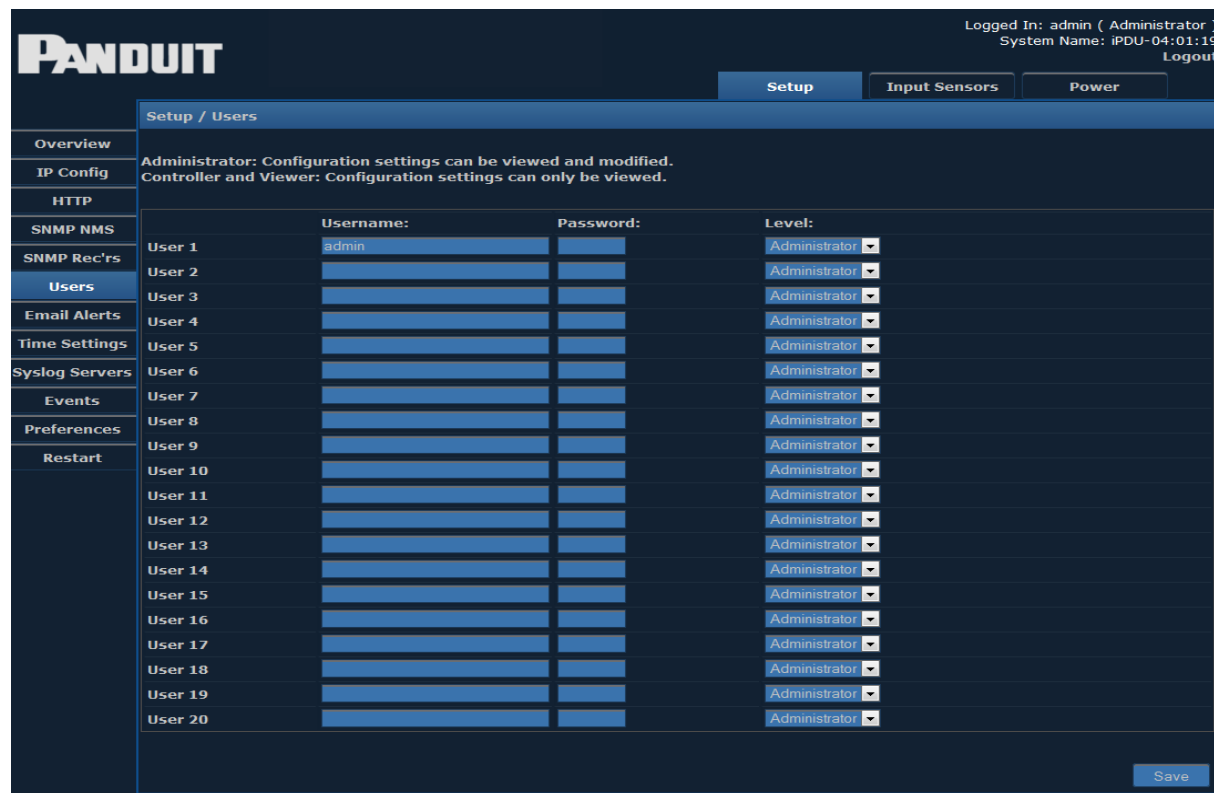

The PDU GUI comes with the Administrator login predefined as:

- **Login:admin**
- **Password:admin**

To add new users, enter a unique **Username** and **Password** for each, then select the desired level of permission. You may configure up to 20 users.

Level of permission for each user can be selected from the drop-down menu on the right. There are three different permission settings:

User Permission Settings	
Administrator	Allows all configuration settings to be viewed and modified
Controller	Allows configuration settings to be viewed, but only certain pages can be modified
Viewer	Allows configuration settings to be viewed only

Email Alerts

On this page, you can edit email alert settings for traps. You may set up to 10 email receivers.

Logged In: admin (Administrator)
System Name: iPDU-04:01:19
Logout

Setup / Email Alerts

SMTP Relay Server: [Input Field]
From Address: [Input Field]
Reply-To Address: [Input Field]

Email Receivers

No.	Destination Address	Enabled	Repeat Timer
1	[Input Field]	<input type="checkbox"/>	0 mins.
2	[Input Field]	<input type="checkbox"/>	0 mins.
3	[Input Field]	<input type="checkbox"/>	0 mins.
4	[Input Field]	<input type="checkbox"/>	0 mins.
5	[Input Field]	<input type="checkbox"/>	0 mins.
6	[Input Field]	<input type="checkbox"/>	0 mins.
7	[Input Field]	<input type="checkbox"/>	0 mins.
8	[Input Field]	<input type="checkbox"/>	0 mins.
9	[Input Field]	<input type="checkbox"/>	0 mins.
10	[Input Field]	<input type="checkbox"/>	0 mins.

Test All Save

Email Alerts	
SMTP Relay Server	The IP Address of the SMTP Server
From Address	Address from which the alert emails are sent
Reply-To Address	Address to which the email receivers can reply
Destination Address	Address that will receive the email alerts
Enabled	Toggle the check box to enable or disable alerts to each address.
Repeat Timer	Number of minutes after which the email alert will repeat

Time Settings

The **Time Settings** page allows you to view or edit the current date and time.

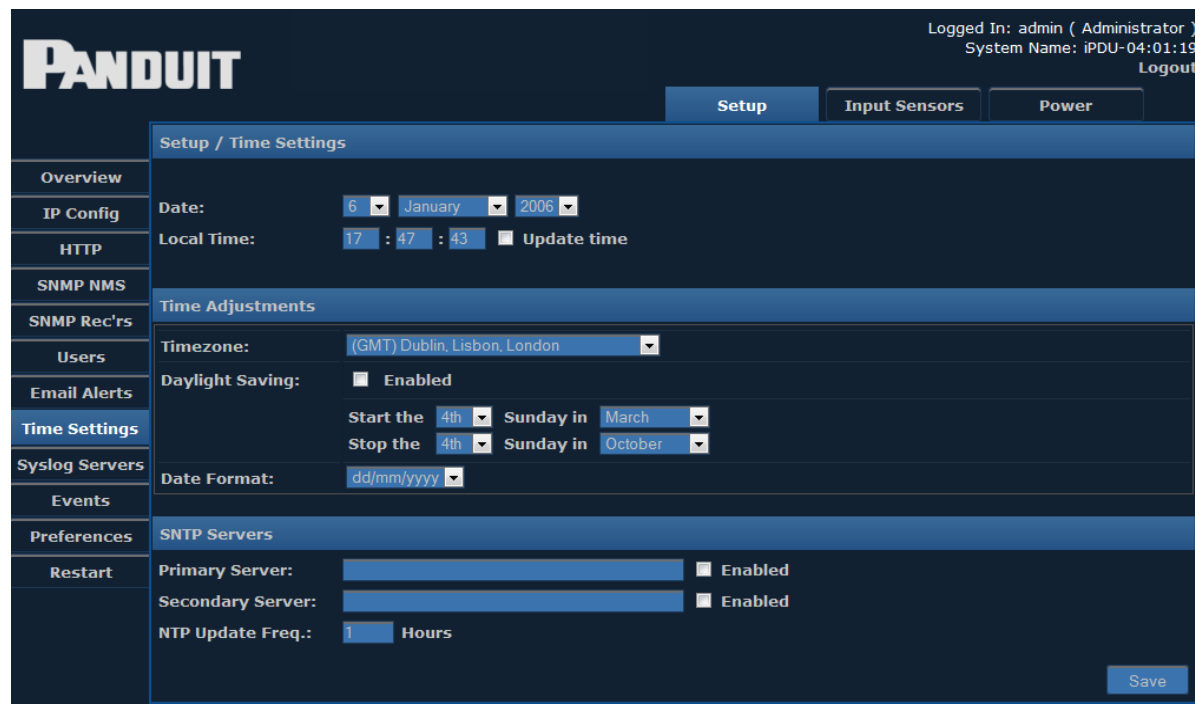

Select the correct day, month, and year from the dropdown menus, and verify the local time. If you want to change the time, you must check the **Update time** checkbox.

Time Adjustments

Select the correct time zone from the drop-down menu.

- **Daylight Saving** can be enabled or disabled by clicking the check box. If Daylight Saving is enabled, select start/stop dates from the subsequent drop-down menus.
- **Date Format** allows the administrator to choose whether the date is displayed with the day or month first. For example, the date August 20, 2013 can be displayed in one of two ways:

20/08/2013 (DD / MM / YYYY)

or

08/20/2013 (MM / DD / YYYY)

Select the desired format from the dropdown menu.

- **SNTP Servers - Simple Network Time Protocol** synchronizes the clocks of computer systems over a network. Enter the IP address of an SNTP server, and specify (in hours) how often the time should be updated.

Syslog Servers

This page allows you to view or edit information about the Syslog Servers currently being used.

The screenshot shows the Panduit web interface for configuring Syslog Servers. The top right corner indicates the user is logged in as 'admin (Administrator)' with system name 'IPDU-04:01:19'. The navigation menu on the left includes Overview, IP Config, HTTP, SNMP NMS, SNMP Rec'rs, Users, Email Alerts, Time Settings, Syslog Servers, Events, Preferences, and Restart. The main configuration area is titled 'Setup / Syslog Servers' and contains two sections: 'Primary Syslog Server' and 'Secondary Syslog Server'. Each section has a 'Display Name' field, an 'IP Address' field, and a 'Port' field (both set to 514). Below these fields are checkboxes for 'Log Event Types': System, Service, Power Strip, Network, Input Config, and Logging. A 'Save' button is located at the bottom right of the configuration area.

From the **Enabled** drop-down menu, you can choose which syslog servers are enabled. Fill in the following fields for each Syslog server.

Syslog Server Setup	
Display name	The name of the Syslog server
IP Address	The IP address of the Syslog server
Port	The number of the port being used
Log Event Types	Click the check boxes to choose which events to log.

Events

The View Events page shows a history of events that have occurred, along with specific details about each event.

The screenshot shows the PANDUIT web interface. At the top right, it indicates 'Logged In: admin (Administrator)' and 'System Name: iPDU-04:01:19'. There is a 'Logout' link. Below this are navigation tabs for 'Setup', 'Input Sensors', and 'Power'. The main content area is titled 'View / Events'. It features a sidebar on the left with menu items: Overview, IP Config, HTTP, SNMP NMS, SNMP Rec'rs, Users, Email Alerts, Time Settings, Syslog Servers, Events (highlighted), Preferences, and Restart. The main area contains a table of events with the following columns: Date / Time, Type, User, and Event Data. The table shows a list of events, including user logins and auto logouts, with the most recent event being a 'Web Preferences Change' by 'User:System' on 'Jan 01 00:00:12'.

Date / Time	Type	User	Event Data
Jan 06 17:47:40	User Login.	User:admin	
Jan 06 17:45:43	Auto Logout.	User:admin	
Jan 06 17:26:06	User Login.	User:admin	
Jan 06 17:24:54	User Logout.	User:admin	
Jan 06 17:24:45	User Login.	User:admin	
Jan 06 17:10:37	User Logout.	User:admin	
Jan 06 17:07:53	User Login.	User:admin	
Jan 06 17:06:26	Auto Logout.	User:admin	
Jan 06 16:59:38	User Login.	User:admin	
Jan 01 00:00:12	Web Preferences Change.	User:System	Skin Id: 255
Jan 16 01:17:33	Application Image Updated.	User:System	
Jan 16 00:33:52	User Login.	User:admin	
Jan 15 22:37:31	Auto Logout.	User:admin	
Jan 15 20:32:21	User Login.	User:admin	
Jan 15 20:31:48	Auto Logout.	User:admin	
Jan 15 20:26:30	User Login.	User:admin	
Jan 15 20:06:03	Auto Logout.	User:admin	
Jan 15 20:00:49	User Login.	User:admin	
Jan 15 19:42:24	Auto Logout.	User:admin	
Jan 15 19:37:18	User Login.	User:admin	

To specify a range of events to view, select the desired year and month from the drop-down menus, then click **Show**.

Date/Time, Type, User, and Event Data for each event are displayed.

Events can be ordered **Latest First** or **Earliest First** by clicking the corresponding radio button.

Preferences

The **Preferences** page allows you to edit system preferences.

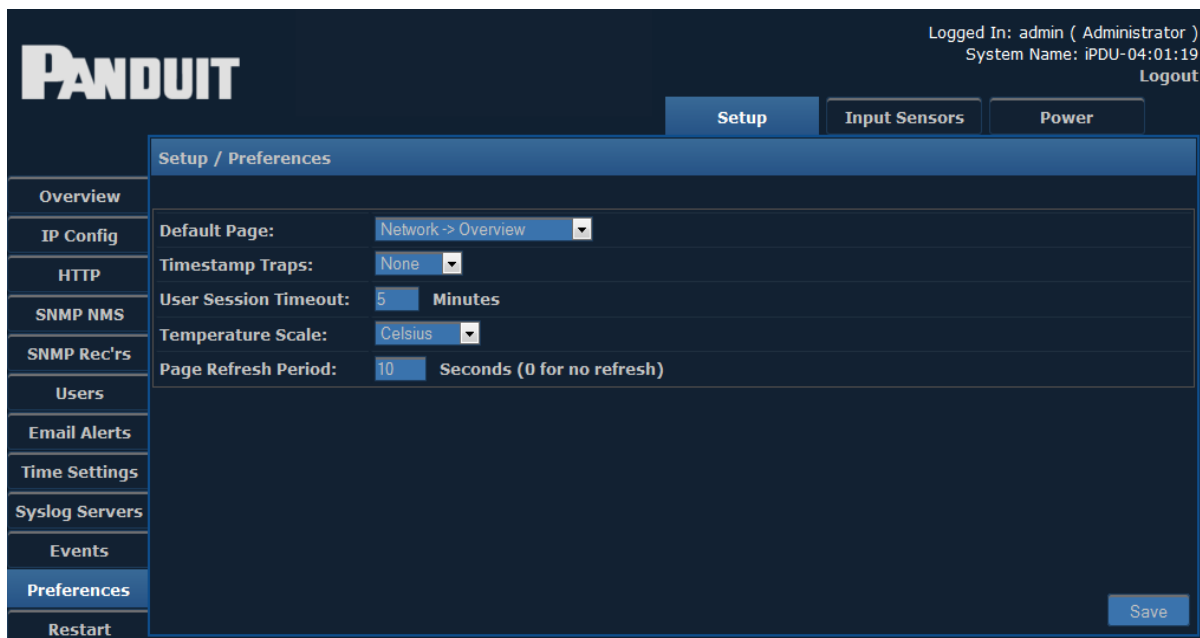

Preferences	
Default Page	From the dropdown menu, select the first page you want to open when a user logs in. The preset default page is the Overview page.
Time stamp Traps	Choose from the dropdown menu where the timestamp will be found on traps. There are three options: <ul style="list-style-type: none"> • Prefix – timestamp at the beginning • Append – timestamp at the end • None – no timestamp
User Session Timeout	Enter a number of minutes, after which a session will be timed out if the user is inactive.
Temperature Scale	Select Celsius, Fahrenheit, or Kelvin from the dropdown menu.
Page Refresh Period	Enter a number of seconds, after which the page will automatically refresh. If 0 is entered, the page will not refresh automatically.

Restart

Clicking the **Restart** option brings up the following screen:

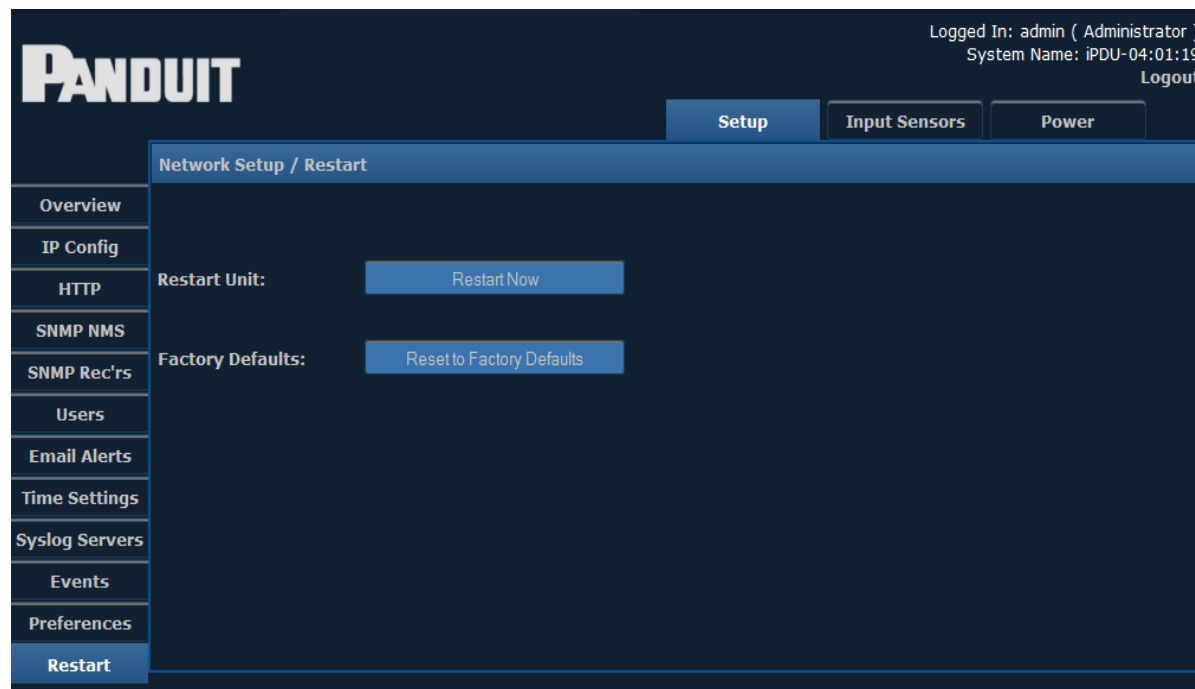

To restart the unit or restore to factory defaults, click the corresponding button.

Note: Resetting to factory defaults will restart the device.

Input Sensors

When the **Input Sensors** module is selected, the following items appear along the left-hand side of the display.

Input Sensors Menu Options	
Status	View information from connected input sensors
Defaults	View or edit default settings for input sensors
Configure	Configure sensor inputs
Sensor Trap Text	View or edit trap text

Detailed information on each of these menu options can be found in the corresponding sections below.





Status

The **Status** page displays information from connected input sensors.

The screenshot shows the PANDUIT web interface. At the top right, it says "Logged In: admin (Administrator)", "System Name: iPDU-04:01:19", and "Logout". Below this are three tabs: "Setup", "Input Sensors", and "Power". The "Input Sensors" tab is selected. On the left side, there is a vertical menu with options: "Status", "Defaults", "Configure", and "Sensor Trap Text". The "Status" option is selected. The main content area is titled "Input Sensors / Status" and contains the text "Information from connected input sensors is presented here." Below this is a table with the following data:

Channel	Type	Detected	Status	Value	Limits			
					UC	UW	LW	LC
1: Input 01	Auto Detect	None	Fault	---	N/A	N/A	N/A	N/A
✓ 2: Input 02	Auto Detect	Temperature	Enabled	24.9 °C	35.0	30.0	15.0	10.0

The following **Status Indicators** are displayed next to input channels to allow quick determination of normal, warning, and critical alarm statuses.

Status Indicators	
	All thresholds within limits
	Upper Control Limit reached/exceeded
	Upper Warning Limit reached/exceeded
	Lower Warning Limit reached/exceeded
	Lower Control Limit reached/exceeded

This page may also display the strings "O/R" and "U/R" in place of the input sensor measurement. This indicates an over-range or under-range condition.

- O/R - Value is Over Range
- U/R - Value is Under Range

Defaults

This page allows you to choose default settings for **Temperature Sensors**, **Humidity Sensors**, **Analog Voltage**, and **Open/Close Contacts**.

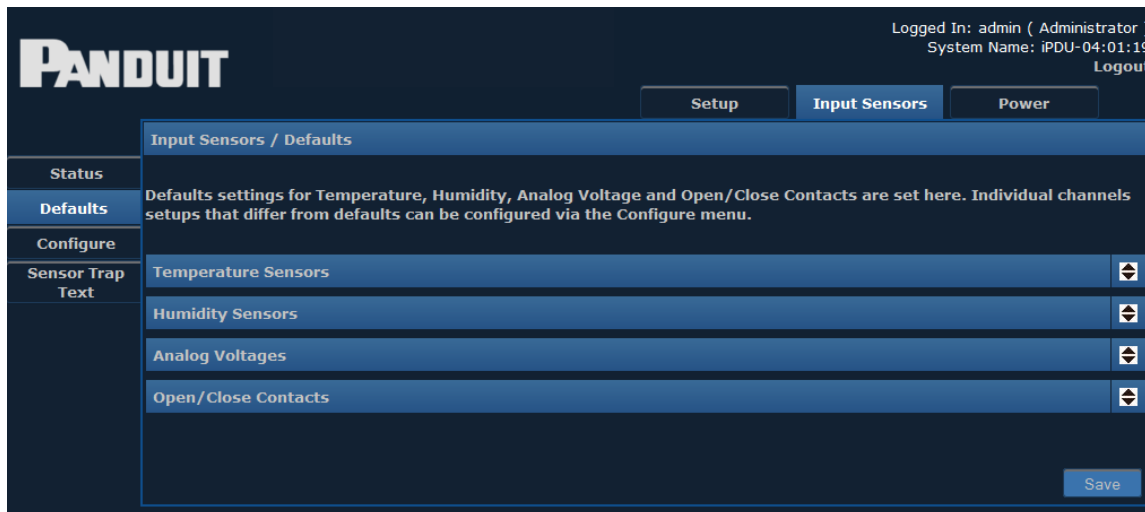

Clicking the arrow opens a drop-down for each Sensor type. For **Temperature Sensors**, the defaults will display similar to the following:

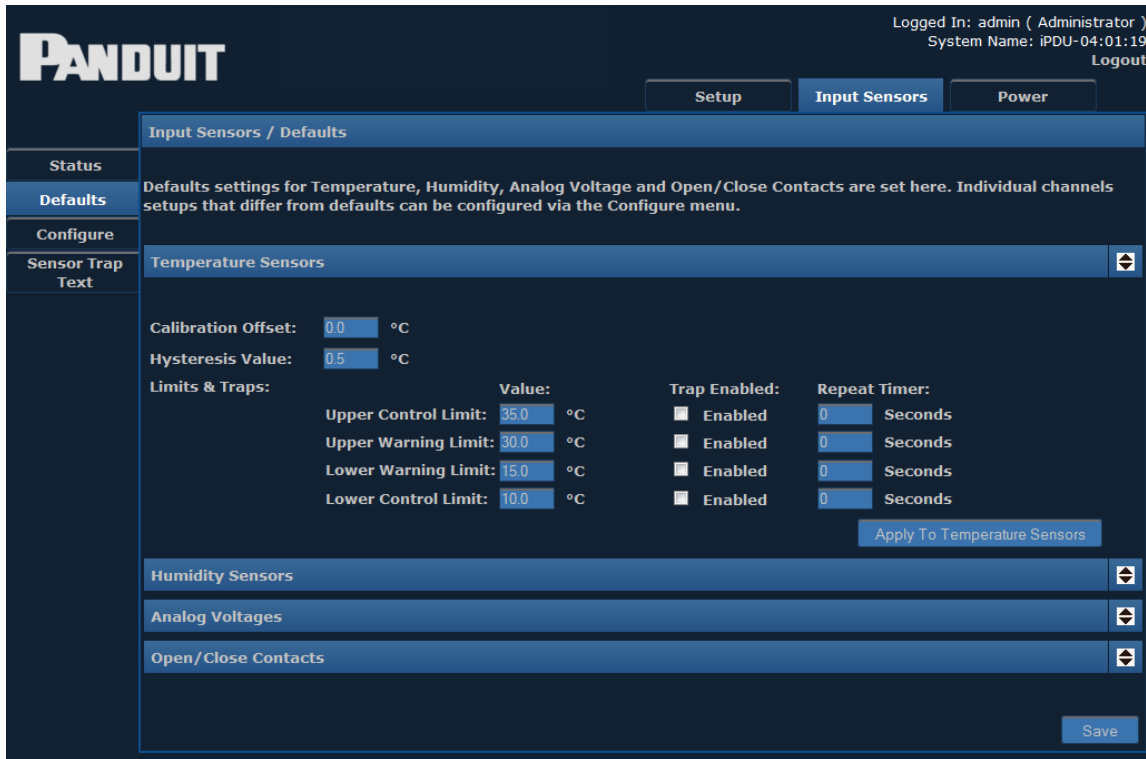

The **Humidity Sensors** screen displays default information as shown below.

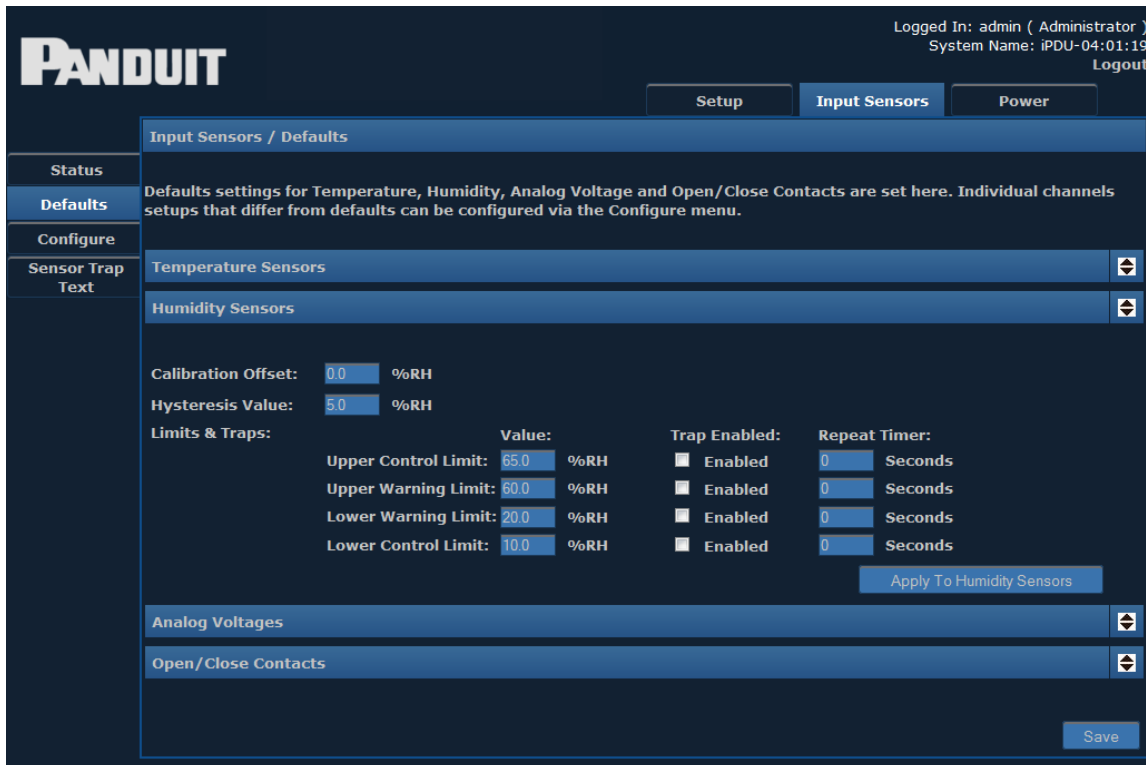

The **Analog Voltage** screen displays default information as shown below.

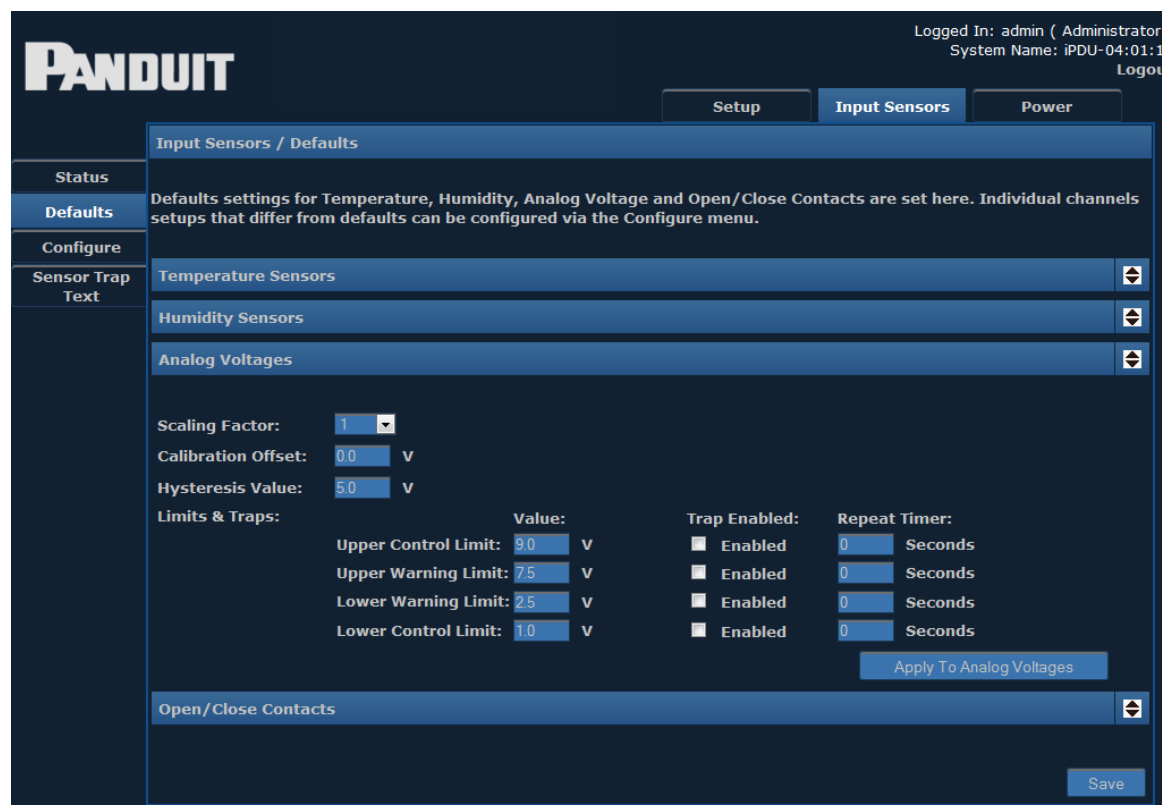

Explanations of the editable fields in the drop-down menus for Temperature, Humidity and Analog Voltage can be found in the table below.

Defaults- Temperature, Humidity, and Analog Voltage	
Scaling Factor (Analog Voltage only)	<p>The scaling factor is a value multiplied against the measured Analog Voltage to produce the Input Sensor measurement.</p> <p><i>Example:</i> Given a measurement of 10 Volts on the input sensor and a Scaling Factor of 100, the web UI and SNMP interface will report a value of $10 \times 100 = 1000$ Volts as the sensor measured value.</p> <p>Note: The [Upper Lower] [Control Warning] Limit fields apply to the post-scaled value.</p>
Calibration Offset	<p>Alters the actual reading of a sensor by the amount specified.</p> <p><i>Example:</i> If a Calibration offset of 6 was used and a sensor's true reading was 36, the indicated reading used for display</p>

Defaults- Temperature, Humidity, and Analog Voltage	
	and alarm purposes would be 42. This works in an identical way for both temperature and humidity sensors.
Hysteresis Value	The hysteresis default value to be applied to sensors is. The value specified is an offset from a sensor's threshold values. <i>Example:</i> A hysteresis value of 5 would mean that in the case of an Upper Control Limits alarm, the alarm value would have to reduce to 5 below the threshold value before another alarm is issued.
Upper Control Limit	The value at which an Upper Control alarm will be issued.
Upper Warning Limit	The value at which an Upper Warning alarm will be issued.
Lower Warning Limit	The value at which a Lower Warning alarm will be issued.
Lower Control Limit	The value at which a Lower Control alarm will be issued.

The **Open/Close Contacts** screen displays the following default information.

Logged In: admin (Administrator)
System Name: iPDU-04:01:19
Logout

Setup **Input Sensors** Power

Input Sensors / Defaults

Status

Defaults Defaults settings for Temperature, Humidity, Analog Voltage and Open/Close Contacts are set here. Individual channels setups that differ from defaults can be configured via the Configure menu.

Configure

Sensor Trap Text

Temperature Sensors

Humidity Sensors

Analog Voltages

Open/Close Contacts

Normal State: Normally Open

Trigger Type: Level

Traps: Trap Alarm Level: Disabled Repeat Timer: 0 Seconds

Apply To Contacts

Save

Defaults- Open/Close Contacts	
Normal State	<p>Normal state specifies the condition in which a contact is considered to be 'Normal', 'Non-alarmed' state. Devices such as smoke alarms and air conditioning units often have normally open contacts. In order to receive alarm indications from these types of units, setting normally open would cause alarms to be issued when the monitored contact closes. Setting normally closed, in the case of a rack cabinet door, would cause an alarm condition when the door was opened.</p>
Trap Alarm Level	<p>Rather than using [Upper Lower] [Control Warning] Limit settings, the Open/Close Contact sensors provide a Trap Alarm Level drop down menu with the following options:</p> <ul style="list-style-type: none"> • Disabled • Critical • Warning • Information <p>When the Trigger Type state occurs, if the Trap Alarm Level is not Disabled, a trap with the given Trap Alarm Level string content is generated.</p>
Trigger Types	<p>Trigger type defaults for Open/Close sensors are specified here. The three available options for trigger types are:</p> <p>Level Level triggering is the default mode. When an input physically transitions from a Normal to Non-Normal state an alarm will be triggered. However the alarm will only persist while the input remains in a Non-Normal state. When the input returns to a normal state the alarm will be cleared.</p> <p>Normal to Non-Normal (Positive Edge) This type of triggering may be used in situations where a momentary type input (e.g. shock sensor, PIR etc.), is used. Since these types of inputs are momentary any alarm condition which occurs, no matter how short, will persist until manually cleared. Positive Edge triggering is used when</p>

Defaults- Open/Close Contacts	
	<p>an alarm is required to persist after an input changes from the Normal state to the Non-Normal state.</p> <p>Non-Normal to Normal (Negative Edge) This type of triggering may be used in situations where a momentary type input (e.g. shock sensor, PIR etc.), is used. Since these types of inputs are momentary any alarm condition which occurs, no matter how short, will persist until manually cleared. Negative Edge triggering is used when an alarm is required to persist after an input changes from the Non-Normal state to the Normal state.</p>
Repeat Timer	Causes alarm traps to be reissued after a specified amount of time if the alarm condition is still present. Setting the timer to zero (0) disables repeat traps.

The drop-down menus can be closed by clicking on the corresponding arrows again.

Configure

The **Configure** page, shown below, allows you to configure sensor inputs.

Logged In: admin (Administrator)
 System Name: IPDU-04:01:19
 Logout

Setup Input Sensors Power

Input Sensors / Configure

Status

Defaults Configure sensor inputs here.

Channel	Name	Type	Detected
1: Cfg 1	Input 01	Auto Detect	None
2: Cfg 2	Input 02	Auto Detect	Temperature

Sensor Trap Text

Clicking one of the configuration buttons – **Cfg 1** or **Cfg 2** – displays the following screen:

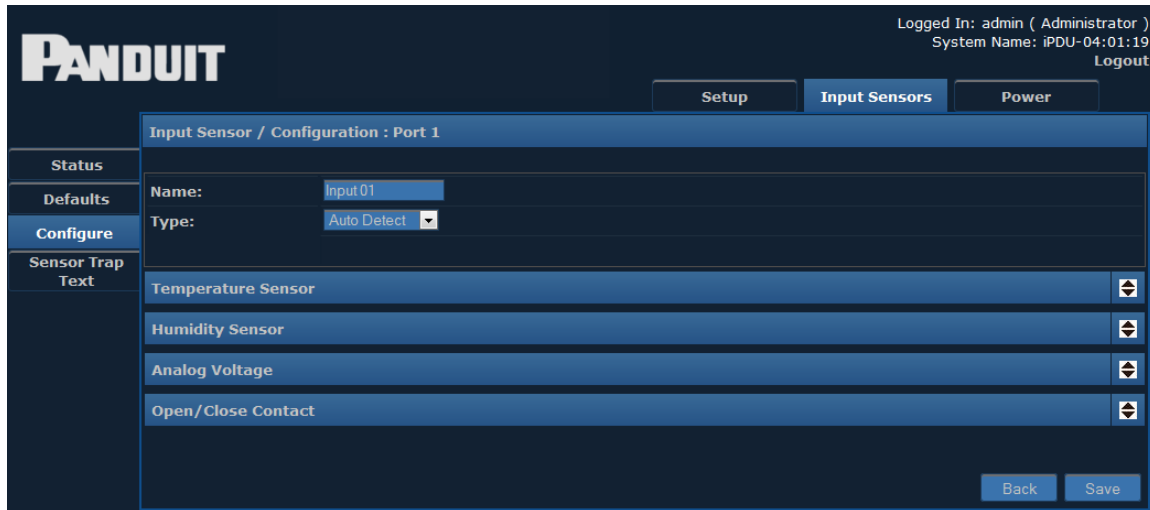

Individual settings can be entered for each input channel. The drop-down menu options are identical to the Defaults page.

Note: The important difference between the menus presented here and the menus presented on the Defaults page is that these settings are applied to individual channels.

The drop-down menus can be opened and closed by clicking the corresponding arrows.

Sensor Trap Text

This page allows you to view or edit the text that will be displayed when certain events occur.

Logged In: admin (Administrator)
System Name: IPDU-04:01:19
Logout

Setup / SNMP (Trap Definitions)

Status

Defaults: When a "Data Type" sensor encounters a "Trap Type" event, the "User Text" is provided in the trap message.

Configure

Data Type	Trap Type	User Text
Temperature	UCL	Temperature Critically High
Temperature	UWL	Temperature Warning High
Temperature	LWL	Temperature Warning Low
Temperature	LCL	Temperature Critically Low
Humidity	UCL	Humidity Critically High
Humidity	UWL	Humidity Warning High
Humidity	LWL	Humidity Warning Low
Humidity	LCL	Humidity Critically Low
Voltage	UCL	Analog Critically High
Voltage	UWL	Analog Warning High
Voltage	LWL	Analog Warning Low
Voltage	LCL	Analog Critically Low

Save

Enter text to be displayed for each type of trap.

Power

When the Power module is selected, the following menu items appear along the left-hand side of the display.

- Status
- Branch Monitoring (if the unit has breakers)
- Status 3-Phase (if the unit is 3-Phase)
- Thresholds
- Configure

Status Single-Phase

The **Status** screen displays information from a connected Single-Phase Power Device.

The screenshot shows the PANDUIT interface with the 'Power' module selected. The 'Power / Status' section displays a table of power device information. The table has columns for Circuit, Name, Volts, Amps, kVA, PF, kW, Hz, and kWh. A single row of data is shown for circuit 01, name A1, with various status indicators (green checkmarks) and numerical values.

Circuit	Name	Volts	Amps	kVA	PF	kW	Hz	kWh
01	A1	✓ 117	✓ 0.0	✓ 0.0	0.00	✓ 0.0	60.0	✓ 14.5

Branch Monitoring

If the power device has breakers, you will see the **Branch Monitoring** button as shown below. Clicking the **Branch Monitoring** button brings up the following screen, displaying information from branch monitoring.

The screenshot shows the PANDUIT interface with the 'Branch Monitoring' button selected. The 'PDU Branches / Status' section displays a table of branch current information. The table has columns for Branch Name and Current. Two rows of data are shown for branches 1: C1 and 2: C2, both with a current of 0.01.

Branch Name	Current
1: C1	0.01
2: C2	0.01

Status 3-Phase

If the device is 3-Phase, you will see the **3-Phase Status** button as shown below. The **3-Phase Status** screen displays information from a connected 3-Phase Power Device.

Power / 3-Phase Status													
Status	Information from connected 3-Phase Power Devices is presented here.												
Status 3-Phase													
Branch Monitoring	PDU			Line Voltages			Phase Currents			Aggregate Power		Aggregate Energy	
Thresholds	Id	Name	L1-L2	L2-L3	L3-L1	L1	L2	L3	Hz	kVA	PF	kW	kWh
	01	A1	198	197	196	0.0	0.0	0.0	60.0	0.0	0.0	0.0	579.5
Configure	Aggregate					0.0	0.0	0.0		0.0	0.0	0.0	579.5

Many of the following pages use abbreviations for various units. A reference table is provided below for convenience.

Units of Measurement		
Current	Amps	Amperes
Power	kVA	Kilovolt amperes
	PF	Power Factor
	kW	Kilowatts
Frequency	Hz	Hertz
Energy	kWh	Kilowatt hours
	kVArh	Kilovolt amperes reactive hours

Thresholds

The **Thresholds** screen displays threshold information from a connected Power Device.

Logged In: admin (Administrator)
System Name: iPDU-04:01:19
Logout

Setup Input Sensors Power

Power / Thresholds

Status

Branch Monitoring

Thresholds

Configure

Threshold Information from connected Power Devices is presented here.

Circuit		Volts				Amps				kVA			kW			kWh				
Id	Name	Value	UC	UW	LW	LC	Value	UC	UW	LW	LC	Value	UC	UW	Value	UC	UW			
01	A1	✓ 117	132	126	114	108	✓ 0.0	28.5	27.0	0.0	0.0	✓ 0.0	5.5	4.5	✓ 0.0	12.0	11.0	✓ 14.5	50000.0	48000.0

Configure

The **Configure** page allows you to view and configure Power Circuits. Depending on the type of unit, not all menu items shown below may be available.

Logged In: admin (Administrator)
System Name: PDU-04:01:19
Logout

Setup Input Sensors Power

Power / Configure

Status

Branch Monitoring

Thresholds

Configure

Power Circuits are configured here. Prev Next

Repeat Timer: Seconds (On Comms Failure)

Circuit	Name	Type
01	<input type="button" value="Cfg"/> A1	Monitor Only
Agg.	<input type="button" value="Cfg"/> Aggregate	Calculated

Clicking the configuration button – **Cfg** – for a circuit brings up a screen similar to the following.



Clicking on the arrows next to each option opens a drop-down similar to the following:

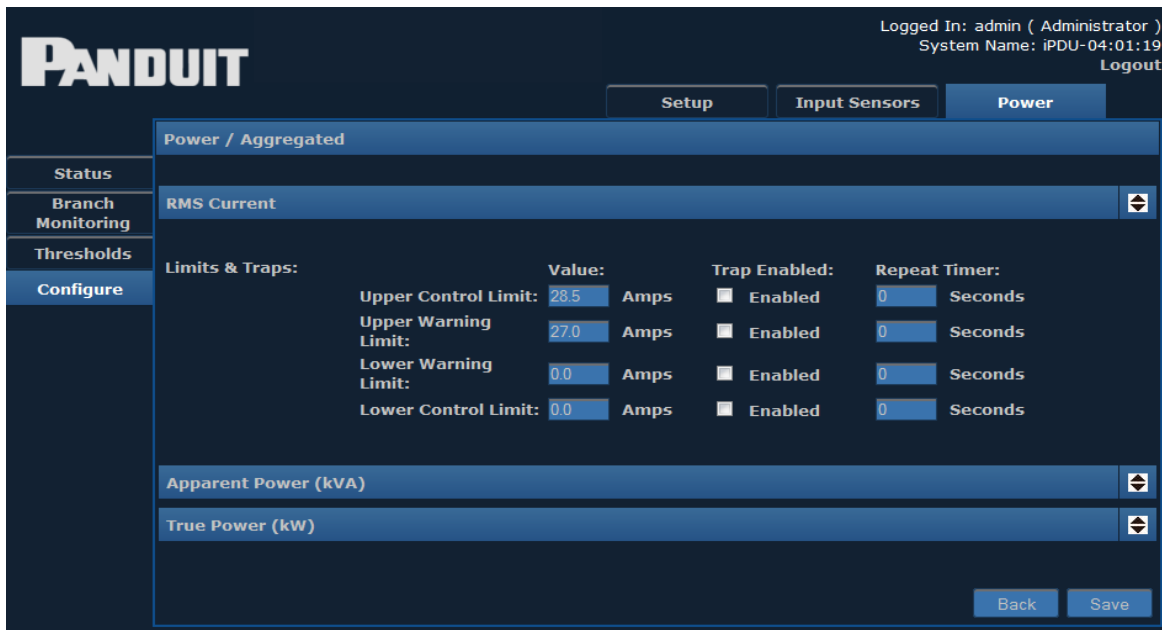

Explanations of the editable fields within the drop-down menus can be found in the table below.

Configure Power Circuits	
Circuit Name	The name of the chosen circuit.
Upper Control Limit	The value at which an Upper Control alarm will be issued.
Upper Warning Limit	The value at which an Upper Warning alarm will be issued.
Lower Warning Limit	The value at which a Lower Warning alarm will be issued.
Lower Control Limit	The value at which a Lower Control alarm will be issued.
Trap Enabled	When the box is checked, enables the unit to send traps relating to the corresponding limit.
Repeat Timer	This entry (in seconds) determines how often repeat traps will be generated if the error condition persists.
Upper Threshold Limit	The value at which a “High” alarm will be issued. The default value is 1.00. This value applies to Power Factor only.
Lower Threshold Limit	The value at which a “Low” alarm will be issued. The default value is 0.01. This value applies to Power Factor only.

The drop-down menus can be closed by clicking the corresponding arrows again.

Clicking the **Monitor Trap Text** button brings up screen to customize the text displayed for each trap type.

PANDUIT

 Logged In: admin (Administrator)
 System Name: iPDU-04:01:19
[Logout](#)

Setup
Input Sensors
Power

Setup / SNMP (Trap Definitions)

Status

Branch Monitoring: When a "Data Type" sensor encounters a "Trap Type" event, the "User Text" is provided in the trap message.

Thresholds	Data Type	Trap Type	User Text
Configure	PDU Volts	UCL	Voltage Critically High
	PDU Volts	UWL	Voltage Warning High
	PDU Volts	LWL	Voltage Warning Low
	PDU Volts	LCL	Voltage Critically Low
	PDU Amps	UCL	Amps Critically High
	PDU Amps	UWL	Amps Warning High
	PDU Amps	LWL	Amps Warning Low
	PDU Amps	LCL	Amps Critically Low
	PDU kWhr	UCL	kWhr Critically High
	PDU kWhr	UWL	kWhr Warning High
	PDU kVA	UCL	kVA Critically High
	PDU kVA	UWL	kVA Warning High
	PDU Pwr Fact	UTL	Power Factor High
	PDU Pwr Fact	LTL	Power Factor Low

Back Save

Enter the desired text in the text box provided, and click the **Save** button to implement your customization.