

smartzone™ UPS

User Manual V3.4

Uninterruptible Power Supply

5-10kVA VRLA (SINGLE PHASE)

5-10kVA LITHIUM (SINGLE PHASE)

10-20kVA (3-PHASE)

Contents

Section 1 – System Overview	3
Key Features.....	4
Basic Operations	5
UPS Overview.....	5
UPS Working Modes.....	5
UPS States.....	11
System Configuration Modes	15
UPS Physical Features and Accessories	19
Physical Features	19
UPS Accessories	30
Section 2 – Front Panel Display	40
Status LED Indicators.....	40
Turning ON/OFF the UPS	41
Starting the UPS on Main Input Power	41
Cold Starting the UPS (Start the UPS on Battery).....	41
Starting a 3-Phase UPS with an Optional Maintenance Bypass Switch Unit.....	41
Switching to the Internal Bypass State.....	42
Switching the 3-Phase UPS to the Maintenance Bypass State (with the Optional Maintenance Bypass Switch Unit - MBS)	42
Switching the 3-Phase UPS to Normal Mode from the Maintenance Bypass State through the MBS	43
Shutting Down the 3-Phase UPS	43
Starting a 1-Phase 5-10kVA UPS (EU region only) with an Optional Maintenance Bypass Switch Unit:	44
Switching the 1-Phase 5-10kVA UPS (EU region only) to the Maintenance Bypass state (with the optional Maintenance Bypass Switch Unit - MBS):	44
Switching the 1-Phase 5-10kVA UPS (EU region only) to Normal Mode from the Maintenance Bypass state through the MBS.....	45
Shutting Down the 1-Phase UPS	46
Display Operations	46

Menu Structure.....	47
Display Icons.....	50
Initialization Page.....	52
Home Pages	53
Status Pages.....	55
Alarm Pages.....	63
Setup Pages.....	65
Maintenance Pages	86
Common Pages	91
About Pages.....	95
Appendix A1: 5 to 10kVA Fault Codes & Alert LEDs	99
Appendix A2: 10 to 20kVA Fault Codes & Alert LEDs.....	106
Appendix B: Troubleshooting.....	114
Appendix C: State Transitions Based on External Events.....	118
Appendix D: Maintenance and Storage.....	120
Maintenance	120
Storage/Transportation.....	120
Appendix E: Configuration Options.....	121
Appendix F: 10 to 20kVA Dry Contact Port Definitions and Assignments	128
Appendix G: 10 to 20kVA Back-feed Port Definition.....	132
Appendix H: 10 to 20kVA REPO Port Definition	133

Section 1 – System Overview

These Panduit SmartZone™ UPS units are true on-line double conversion systems that deliver highly efficient and reliable power protection for your computer, IT, communications, and automatic equipment. These units have high electrical performance, intelligent monitoring, and network functionality to properly monitor and condition the world's power anomalies (power failures, power sags, power surges, under-voltages, over-voltages, electrical line noises, frequency variations, switching transients, and harmonic distortion).

Each UPS comes equipped with a color display and has multiple options for interfacing with the unit. The UPS is standardly equipped with a network card for remote network monitoring, control, and configuration. The UPS may be optionally ordered without a network card. Additionally, a Network Card or a Dry Contact Relay Card may be ordered as accessories.

These UPS units support either VRLA (Valve Regulated Lead-acid) or Li-Ion (LiFePO4) batteries as the backup power storage system. Refer to the appropriate model for associated battery support. The topology of these units is on-line double conversion with a built-in economy (ECO) mode. The on-line double conversion architecture provides the best power conditioning by recreating a true sinewave on the UPS outputs. The on-line double conversion topology converts the input AC power to a DC power and then regenerates the AC power on the UPS outputs. This double conversion allows the UPS to eliminate the inconsistencies in the input power provided by the utility company. The UPS may be optionally configured to ECO mode to increase efficiency when the input power is known to be stable (requires minimal conditioning).

Key Features

- **Integrated Data Center Solution** – These UPS units integrate with multiple External Battery Packs (EBP), offering an excellent choice for data center deployment.
- **Easy to Maintain** – All UPS units support hot swappable battery cartridges.
- **Easy to Maintain** – All UPS units have an option to switch to bypass state.
- **Easy to Maintain** – The EU region UPS units may integrate an external Maintenance Bypass Switch (MBS), offering ease of maintenance while maintaining power to the loads.
- **Reliable** - All UPS units are controlled by Digital Signal Processors (DSPs) which increases reliability, performance, self-protection, and self-diagnostics.
- **Intelligent Charging Method** - The UPS units have an advanced three-stage charging method to extend the battery life and ensure fast charging.
 - **1st stage:** constant current charging to quickly charge back to 90% without over voltage.
 - **2nd-stage:** constant voltage charging to make sure batteries are fully charged with out over voltage.
 - **3rd stage:** float voltage charging to ensure the battery stays charged to the optimal level.
- **Ease of Use** - User Friendly Color Display with Color Status LEDs allow the user to easily view UPS status and set operational parameters.
- **Intelligent Monitoring Function** – UPS units are standardly equipped with a Network card for remotely controlling and monitoring the UPS via a user-friendly Web Interface.
- **Load Shedding** – All UPS units that have outlets with one or two controllable outlet groups may be used to shed non-critical loads while on battery backup.
- **Load Shedding** - All UPS units with a network card have the capability to gracefully shutdown smart loads.
- **EPO Function** - All UPS units are equipped with an Emergency Power Off (EPO) interface to turn OFF the UPS output via a remote switch.
- **Short circuit protection** – All UPS units can protect against an output short circuit.

Note: Short circuit protection is available only when power is provided through the inverter in a double conversion unit. The unit will be damaged if a short circuit occurs on the output when the unit is providing power through the bypass power path.

Basic Operations

The basic operations of a double conversion UPS are explained through the high-level generic block diagram in Figure 1. This block diagram is not the actual block diagram of the UPS units.

UPS Overview

The input of the UPS is connected to an AC power source via an input plug or hardwire connections. The output is connected to loads via outlets or hardwire connections on the UPS. The load may be powered from the input source or the battery. The UPS power switching circuitry may be isolated from the power chain while continuing to power the load (ECO Mode or bypass state). The following UPS Mode and UPS State sections use the simplified block diagram to help explain the modes and states of the UPS.

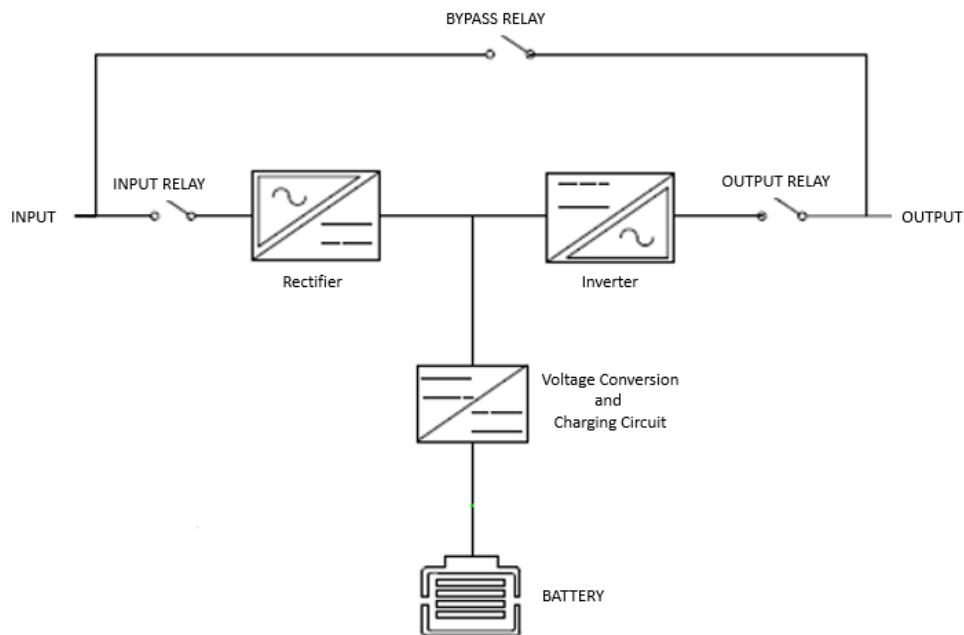

Figure 1: High-level Generic Double Conversion UPS Block Diagram

UPS Working Modes

The UPS may be configured into four different working modes. This section provides an explanation of these settable working modes. One of the four working modes is manually configured into the UPS at setup time. The selected mode will become the Default state of the UPS until the working mode is manually changed.

Normal Mode (NOR)

Normal mode (on-line double conversion) is the default working mode of these UPS units. When the UPS is set for Normal mode (double conversion), it provides a stable pure sinusoidal AC power output and charges or maintains the charge on the battery.

Input Relay: Closed
 Output Relay: Closed
 Bypass Relay: Open

The rectifier derives power from the AC Input and supplies DC power to the inverter while simultaneously charging or maintaining the charge on the battery. The inverter inverts the DC power to AC power with a stable pure sinusoidal AC voltage and current waveform and supplies it to the load.

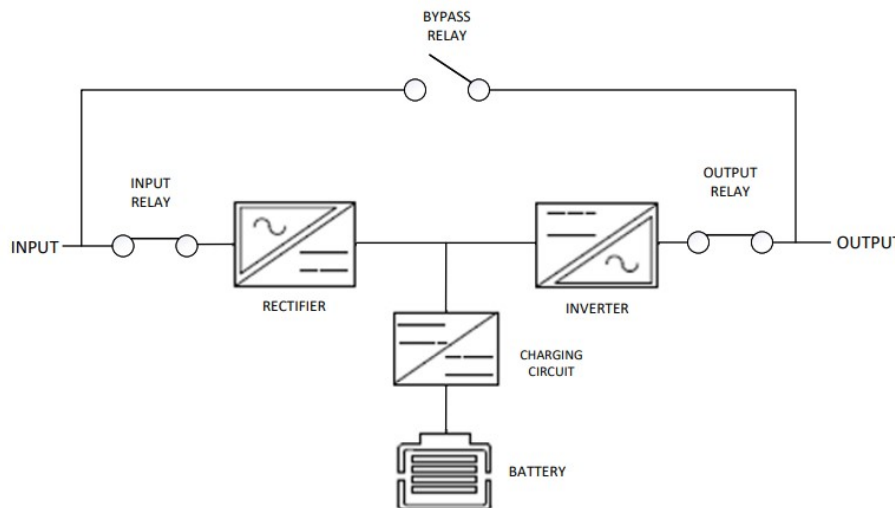

Figure 2a: Normal (“Online”) mode block diagram

When the UPS is operating in Normal mode, if the input power is lost or has any other anomalies that are outside of the set ranges:

- The batteries will stop charging (input relay will open)
- The bypass relay will remain opened
- The output relay will remain closed
- The battery will start providing the DC power to the DC to AC inverter, continuing to provide uninterrupted AC power to the load.

The UPS is now in the Battery state and will indicate an alarm. The UPS will continue to provide power to the load for a limited time (runtime of the battery backup system)

connected to the UPS for the percentage of load connected).

If an internal or an external output event occurs while operating in Normal mode:

- The input relay may open (depending on the internal event)
- the output relay will open
- The bypass relay will close (if the input is within range) continuing to provide minimally conditioned AC power to the load.

The UPS is now in the Bypass state and will indicate an alarm. Refer to [Appendix C: State Transitions Based on External Events](#).

Note: This unit has short-circuit protection when power is being provided to the load through the inverter. If the unit is in ECO mode or the bypass state when a short-circuit occurs on the output of the UPS, the UPS unit may be damaged.

ECO Mode

When the power quality requirements for the load are not critical and the input source is stable (no power anomalies), the UPS may be set to Energy Savings (ECO) mode to increase the efficiency of the power supplied through the UPS. In ECO mode, all input voltage and frequency variations will be passed along to the load. When the UPS is in ECO mode the source power is minimally conditioned.

Note: After selecting this configuration, it may take approximately 60 seconds for the system to fully transition to ECO mode (Bypass relay closed state).

Input Relay: Closed

Output Relay: Open / Standby

Bypass Relay: Closed

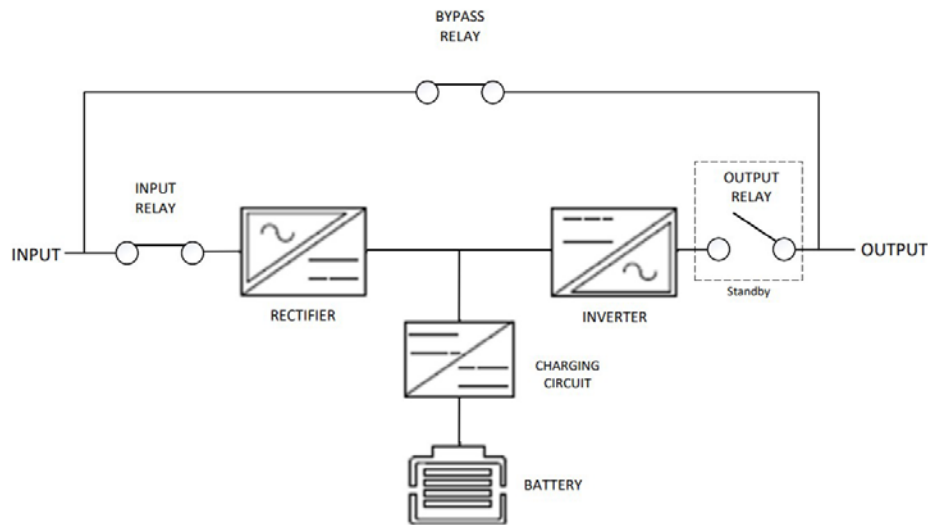

Figure 2b: ECO mode block diagram (Inverter Standby)

While the UPS is operating in ECO mode, if the input power has any other anomaly (power sags, power surges, under-voltages, over-voltages, electrical line noises, frequency variations, switching transients, and harmonic distortion) that is outside of the bypass set ranges:

- The input relay will remain closed (continuing to charge the battery – if the anomaly is still within the operating range of the UPS)
- The bypass relay will open
- The output relay will close
- The rectifier will start providing the DC power to the DC to AC inverter, continuing to provide uninterrupted AC power to the load.

The UPS is now considered in the Normal state.

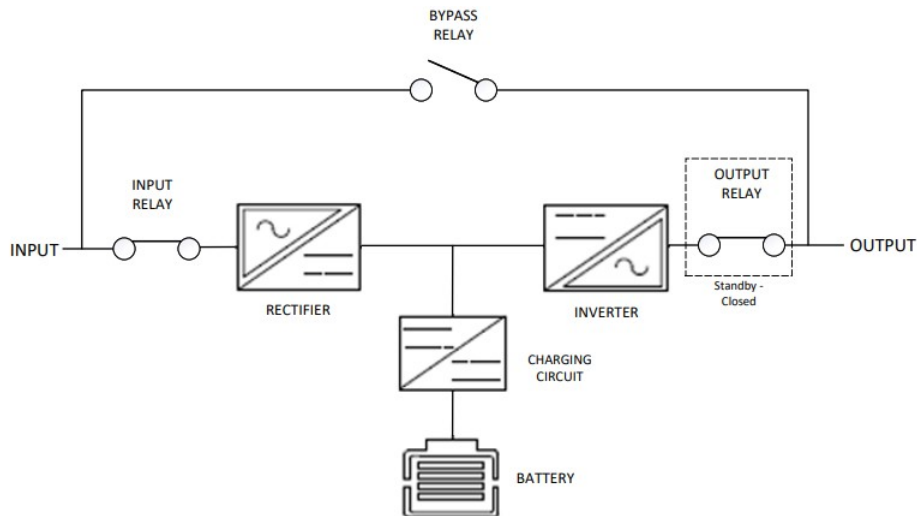

Figure 2c: ECO mode block diagram (Inverter active)

If the anomaly corrects itself, the UPS will revert back to the previous ECO state.

If the anomaly is outside of the UPS operating range, then the UPS will transition to the Battery state. (Refer to [Appendix C: State Transitions Based on External Events.](#))

If an internal or an external output event occurs while operating in ECO mode, the bypass relays will open, the input relay will open, and the output will shut down. AC power to the load will be lost.

Note: This unit has short-circuit protection when power is being provided to the load through the inverter. If the unit is in ECO mode or in the bypass state when a short-circuit occurs on the output of the UPS, the UPS unit may be damaged.

If the input power is lost while the UPS is operating in ECO mode:

- The batteries will stop charging (input relay will open)
- The bypass relay will open
- The output relay will close
- The battery will start providing the DC power to the DC to AC inverter, continuing to provide uninterrupted AC power to the load.

The UPS is now in the Battery state. The UPS will continue to provide power to the load for a limited time (runtime of the battery backup system connected to the UPS for the percentage of load connected).

Convert Frequency (CF) Mode

The UPS may be set to Convert Frequency (CF) mode to increase the allowable input frequency range of the UPS while maintaining the desired output frequency. Setting the UPS to CF mode may require the UPS unit to be derated. The 5-10kVA UPS units in CF mode are derated to 80% of the maximum output but will maintain a 50Hz or 60Hz output frequency, depending on configuration, with an input frequency range from approximately 40Hz to 70Hz. The 10-20kVA 3-phase UPS units in CF mode have no derating and will maintain a 50Hz or 60Hz output frequency, depending on configuration, with an input frequency from 40Hz to 70Hz. When CF mode is set, the Bypass state is automatically disabled (the unit cannot switch to the Bypass state under any conditions, frequency conversion is not supported through the bypass path).

While the UPS is operating in CF mode, if the input power is lost or has any other anomalies that are outside of the set ranges:

- The batteries will stop charging (input relay will open)
- The bypass relay will remain opened
- The output relay will remain closed, and the battery will start providing the DC power to the DC to AC inverter, continuing to provide uninterrupted AC power to the load.

The UPS is now in the Battery state. The UPS will continue to provide power to the load for a limited time (runtime of the battery backup system connected to the UPS for the percentage of load connected).

If an internal or an external output event occurs while operating in CF mode, the output relay will open, and the output will shut down. AC power to the load will be lost. Refer to [Appendix C: State Transitions Based on External Events](#).

Generator Mode

The UPS may be set to Generator mode to enable the UPS to have a wider input frequency range (41Hz to 69Hz). Setting the UPS to Generator mode may require the UPS unit to be derated. The 5-10kVA single-phase UPS units in Generator mode are derated to 75% of the maximum output but will maintain a 50Hz or 60Hz output frequency over the full input frequency range. The 10-20kVA 3-phase UPS units do not have a Generator mode setting. These units always operate with a wider input frequency range with no derating.

Note: The Generator mode is saved on the 5-10kVA UPS units; when the 5-10kVA UPS unit is powered OFF and restarted, the unit will restart in Generator mode.

While the UPS is operating in Generator mode, if the input power is lost or has any other anomalies that are outside of the operating range of the UPS,

- The batteries will stop charging (input relay will open)
- The bypass relay will remain opened
- The output relay will remain closed, and the battery will start providing the DC power to the DC to AC inverter, continuing to provide uninterrupted AC power to the load.

The UPS is now in the Battery state. The UPS will continue to provide power to the load for a limited time (runtime of the battery backup system connected to the UPS for the percentage of load connected).

If an internal or an external output event occurs while operating in Generator mode, the input and output relays open and the bypass relay closes (assuming the input is not outside of the input bypass range), continuing to provide unconditioned AC power to the load. The UPS is now in the Bypass state with no frequency or voltage conditioning. Output frequency and voltage will equal input frequency and voltage. Refer to [Appendix C: State Transitions Based on External Events](#).

Note: The UPS does not have output short circuit protection in the Bypass state.

UPS States

The UPS automatically transitions to different states based on internal or external events; the user may also force the UPS into some states through one of the user interfaces. There are eight different states that the UPS may be in. Refer to [Appendix C: State Transitions Based on External Events](#).

Normal State

The UPS will go into the normal state when the UPS is set to Normal Mode at setup time. This is the default mode and state that the UPS will power up in on new units from the factory. If the UPS is set for Normal Mode, the Normal state is the default state where the UPS will return to after the internal or external event has been cleared or the forced state has expired.

If an internal or external event occurs while operating in the normal state, the UPS will automatically transition to battery, bypass, fault, or battery test state depending on the

event.

ECO State

The UPS will go into the ECO state when the UPS is set to ECO Mode at setup time. If the UPS is set for ECO Mode, the ECO state is the default state where the UPS will return to after the internal or external event has been cleared or the forced state has expired.

If an internal or external event occurs while operating in the ECO state, the UPS will automatically transition to normal, battery, fault, or battery test state depending on the event.

CF State

The UPS will go into CF state when the UPS is set to CF Mode at setup time. If the UPS is set for CF Mode, the CF state is the default state where the UPS will return to after the internal or external event has been cleared or the forced state has expired.

If an internal or external event occurs while operating in the CF state, the UPS will automatically transition to battery, bypass, fault, or battery test state depending on the event.

Gen State

The UPS will go into Gen state when the UPS is set to Generator Mode at setup time. If the UPS is set for Generator Mode, the Gen state is where the UPS will return to after the internal or external event has been cleared or the forced state has expired.

If an internal or external event occurs while operating in the Gen state, the UPS will automatically transition to battery, bypass, fault, or battery test state depending on the event.

Battery State

The UPS automatically transitions to the Battery state with no power interruption to the load when input power is out of the set range or power is lost.

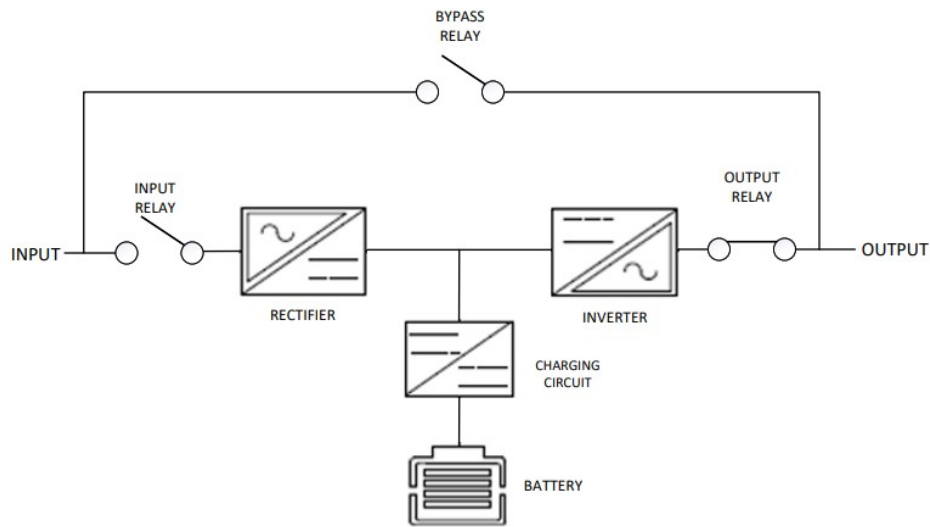

Figure 3a: Battery state block diagram

The UPS will automatically return to the default state when the input source recovers.

If an internal or external output event occurs while operating in the Battery state, the output will shut down. AC power to the load will be lost.

Bypass State

The UPS may automatically transition to the Bypass state with no power interruption when an internal or an external output event occurs (depending on the event). The UPS may also be set to the Bypass state by turning OFF the inverter, but the input voltage and frequency must be within the specified upper and lower limits of the bypass as specified during the UPS setup. For the 5-20kVA UPS units, turn ON/OFF the inverter through the Common Menu page. While the UPS is in the Bypass state, the source power is minimally conditioned. Most variations in frequency and voltage will get passed on to the load.

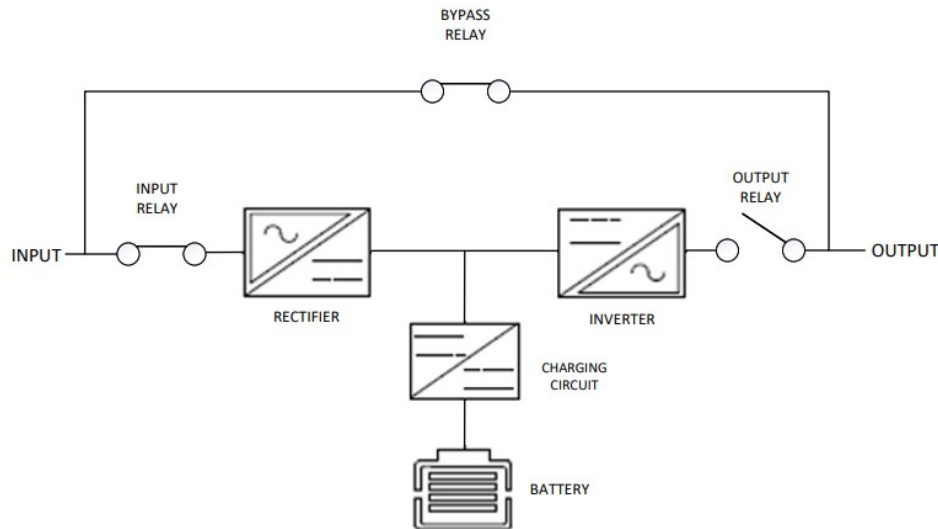

Figure 3b: Bypass state block diagram

If an internal or an external output event occurs while operating in the Bypass state, the UPS will transition to the Fault state. The output will shut down, and AC power to the load will be lost.

Maintenance Bypass State

Maintenance Bypass state is supported on the Single-Phase 5-10kVA EU region and 3-Phase 10-20kVA UPS units only. Manual intervention is required to transition into and out of this state. This state also requires a Maintenance Bypass Switch (MBS) unit, sold as a UPS accessory. The UPS may be switched into the Maintenance Bypass state, through a sequence of switches on the MBS unit, to perform periodic maintenance on the UPS. The MBS unit will electrically disconnect the UPS from the system. In the Maintenance Bypass state, the source power is provided to the load with no power conditioning. All UPS maintenance should be performed in off hours by qualified personnel only.

Note: All UPS units may be set to maintenance bypass state by connecting or removing a jumper plug in the rear panel labeled ‘MAINT’. This state is intended for exchanging batteries.

Note: If input power is lost while operating in the Maintenance Bypass state, AC power to the load will be lost.

Refer to the [Maintenance Bypass Switch \(UMB20K\)](#) section in this document and the installation guide for additional details.

Fault State

The UPS automatically transitions into the fault state when the UPS is unable to provide power to the load. The input, output, and bypass relays will all open. If the fault clears, the UPS should transition back to the Default state (depending on the fault that is cleared).

Battery Test State (Self-Check State)

The UPS may be manually or automatically put into the Battery Test state (sometimes referred to as the Self-Check State), but the UPS will automatically transition back to the Default state when the test is complete. The battery test will automatically run when the UPS is powered ON and periodically while the unit is operating. The battery test may also be manually executed at any time. The frequency and duration of the battery test may have an impact on the battery life. All battery tests are preset for a duration of 10 seconds. The frequency of the test is user selectable. For the 5-20kVA UPS units, the battery test may be automated through the network card or scheduled through the Maintenance Menu on the UPS Display.

Note: If automatic battery testing is setup through the Network Card, then automatic battery testing should be disabled through the Maintenance Menu on the UPS Display. If automatic battery testing is setup through the Maintenance Menu on the UPS Display, then automatic battery testing should be disabled in the Network Card.

When the battery test runs, the battery discharges for 10 seconds through both the externally connected load and internal load.

Note: If a battery test is run just after the UPS was running in the battery state, it may produce a Battery low (EOD) alarm and/or a Battery Self-Test error because the battery was too low when the test was started. This does not mean your battery is defective or at end of life. Try rerunning the battery test after the battery has been fully charged. If Battery low (EOD) alarm is already present when the battery test is initiated, the UPS will not start the battery test.

System Configuration Modes

The 10-20kVA 3-phase and 5-10kVA Lithium UPS units allow the user to change the system configuration. The system configuration allows the UPS to be connected into a larger system. By default, all UPS units are configured to be their own independent system.

Single Mode

By default, all UPS units are configured and wired as a single mode system. A single mode system is a single UPS (and EBP unit(s)) connected to an AC power source, and

that UPS provides the AC power to the load(s).

Parallel Mode

The 10-20kVA 3-phase and 5-10kVA Lithium UPS units may optionally be configured and wired as a Parallel mode system. A Parallel mode system allows two to four UPS units of the same rating to be connected in parallel. The Parallel mode system allows the group of UPS units to behave as one large UPS system and/or as a system with redundancy.

Note: Redundant units are not calculated in the overall capacity of the parallel system.

SKU	Max. Load Capacity 2 units in parallel.	Max. Load Capacity 3 units in parallel.	Max. Load Capacity 4 units in parallel.
U05N11L	10 kVA / 9 kW	15 kVA / 13.5 kW	20 kVA / 18 kW
U05N12L	10 kVA / 10 kW	15 kVA / 15 kW	20 kVA / 20 kW
U06N11L, U06N12L	12 kVA / 12 kW	18 kVA / 18 kW	24 kVA / 24 kW
U10N11L, U10N12L	20 kVA / 20 kW	30 kVA / 30 kW	40 kVA / 40 kW
U10N32V	20 kVA	30 kVA	40 kVA
U15N32V	30 kVA	45 kVA	60 kVA
U20N32V	40 kVA	60 kVA	80 kVA

Note: There are critical restrictions for connecting these units in parallel.

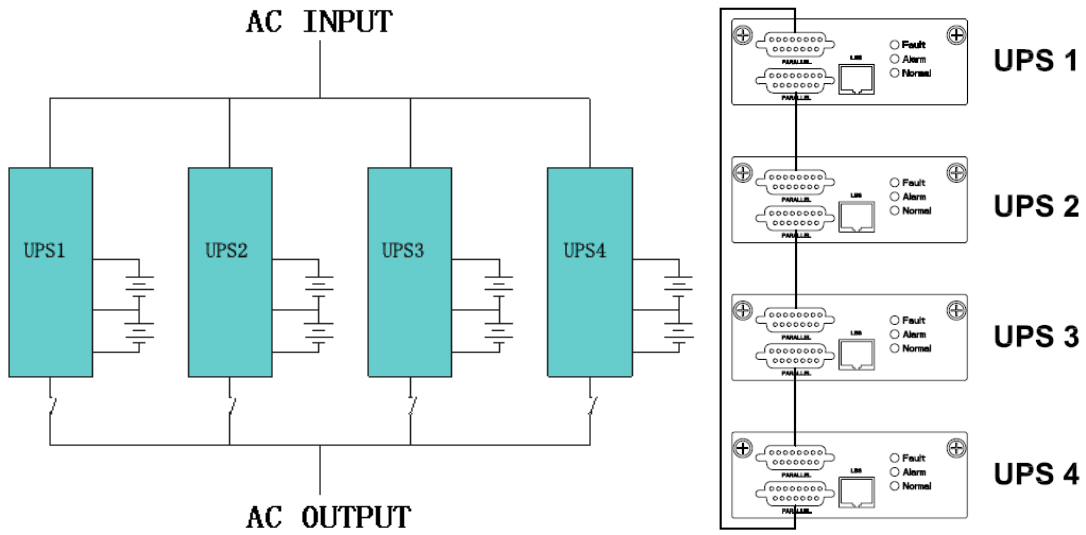

Figure 4a: Parallel System Power/Control Connections (3-Phase UPS)

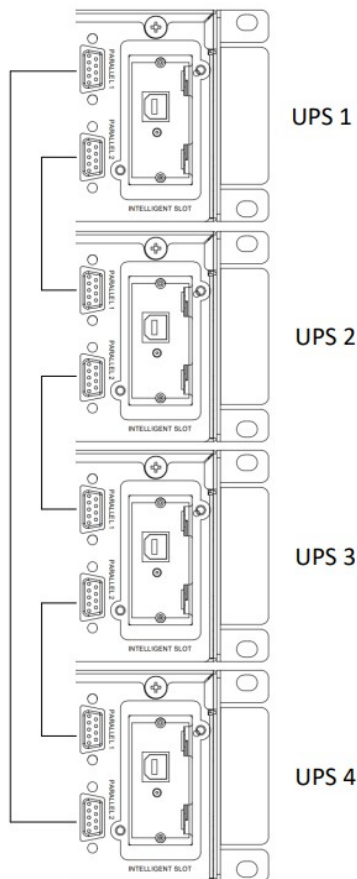

Figure 4b: Parallel System Control Connections (5 to 10kVA Lithium UPS)

Parallel Mode System Restrictions

To ensure that all UPS units in the Parallel mode system configuration are equally utilized and comply with relevant wiring rules, the following restrictions must be met:

- All UPS units must be of the same rating.
- The input main of all the UPS units must be connected to a common input bus.
- The input bypass of all the UPS units must be connected to a common input bus.
- The output of all the UPS units must be connected to a common output bus.
- The length and specification of all UPS power cables (main input, bypass input, and the output cables) must be the same type and same length. This helps to facilitate load sharing and zero crossing alignment between the UPS units when operating in Parallel Mode.

Parallel Mode Setup and Startup

Each UPS unit in the Parallel mode system must be properly configured before the outputs of the Parallel mode system are connected.

1. Confirm that all breakers in the Parallel Mode system are open.
2. Confirm that the input power connections and the input phase sequence is correctly connected. Leave outputs disconnected.
3. Confirm that the battery connections of all EBP groups are correct.
4. Confirm that the parallel control cables are connected in a ring configuration between all UPS units in the Parallel mode system (refer to the control connections in the figures above).
5. The parallel mode system setting must be configured on each unit before the outputs are connected.
6. With the outputs disconnected, power ON all UPS units. On the first unit, set the System Configuration mode to Parallel, set the working mode to Normal, and set the Parallel ID to 1. Then set the number of parallel UPS units (Parallel Basic Units) to the number of units that will be in the system (2-4). Then set the number of the redundant UPS units (Parallel Redundancy Units) to the number of redundant units in the system, if redundancy is desired in the system (0-3, no redundancy = 0).

Note: Redundant units are not calculated in the overall capacity of the parallel system.

7. Follow the configuration steps above to setup the second UPS unit in the Parallel mode system. This unit should have all the same settings except the Parallel ID on this UPS unit should be 2.
8. Make these configuration settings for the rest of the UPS units in the Parallel mode system; making sure the Parallel ID is unique for each UPS unit in the Parallel mode system.

9. After all UPS units in the Parallel mode system are configured, power OFF all the UPS units in the system. Connect the outputs of all the UPS units in the Parallel mode system together and to the load.
10. Power ON all the UPS units in the Parallel mode system.
11. Then turn ON all battery breakers and confirm the parameters (V/I) are normal.
12. Toggle the utility breaker OFF and ON to confirm that all the UPS units in the Parallel mode system transition from the Default state to the Battery state and then back to Default state.
13. To operate the Parallel mode system in other configurable modes, find the master unit (check the Status Info page of each unit in the system for the Master unit – this will typically be the unit with the Parallel ID set to 1) and change the working mode on this unit to the desired mode. This will change all the UPS units in the Parallel mode system to the selected mode.

UPS Physical Features and Accessories

The following sections provide an overview of the human and electrical interfaces on the UPS unit. All UPS units are rack mountable with a display on the front side of the unit.

Physical Features

UPS Front Panel

The UPS Front Panel for the 5-10kVA 1-Phase VRLA and 10-20kVA 3-Phase VRLA Models are the same. Air flow vents occupy about $\frac{3}{4}$ of the front panel and a display module occupies the right $\frac{1}{4}$ of the front panel.

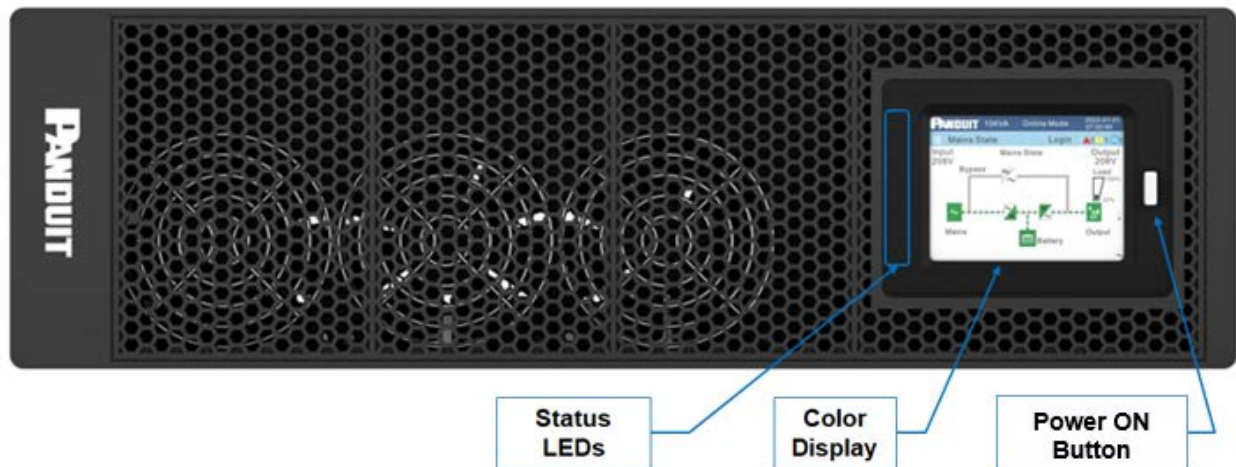

Figure 5a: 5 to 20kVA VRLA Front Panel

The UPS Front Panel for the 5-10kVA Lithium models is a smaller, 2RU, footprint. The

display module occupies the left ¼ of the front panel.

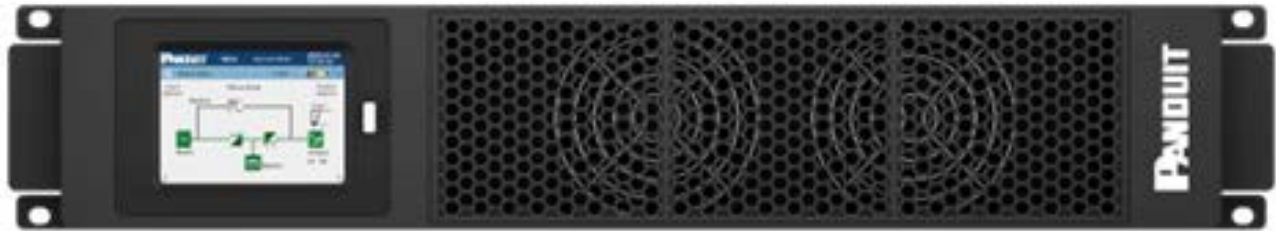

Figure 5b: 5 to 10kVA Lithium Front Panel

The front panel of all UPS units contains four Status LEDs, a 3.5-inch color touch screen display and a power ON button.

[Air Flow Vents](#)

The air flow vents are very critical to the operation of the UPS unit. These vents must remain clean and clear of all objects that may restrict the air flow through the UPS unit.

[Status LEDs](#)

Each unit has four Status LEDs, Normal LED (green), Battery LED (yellow), Bypass LED (blue), and Alert LED (Red or Yellow). These LEDs provide a quick high-level view of the units operating conditions. Refer to Front Panel Display section for further details.

[Color Display](#)

The unit has a 3.5-inch touch screen color display. This display is used for monitoring, controlling, and configuring the UPS. The display should automatically adjust to the orientation of the unit. To lock the proper orientation, manually configure the setting in the screen setup page on the display.

[Power ON Button](#)

The UPS has a single push button switch to the right of the display. This push button switch is used to cold start the UPS. VRLA UPS units may be cold-started at any time if the battery is connected and the breakers are on. Lithium UPS units cold-start function requires the battery to first synchronize with the UPS and be charged to a capacity above 10%.

[UPS Rear Panel](#)

The rear panel varies based on the UPS unit model. Refer to the UPS Physical Feature call out tables and the Model specific figures in the section for details.

Intelligent Slot (INTELLIGENT SLOT)

Each UPS unit is standardly equipped with a Network management Card. Alternatively, the UPS may be ordered with an empty Intelligent Slot, and later updated with a UPS Network Management Card or a UPS Relay Card.

EPO/REPO Signal Port (EPO/REPO)

The 5-10kVA single-phase UPS units come equipped with an Emergency Power Off signal port, labeled EPO. These UPS units come equipped with a 2-pin plug wired to provide a short that results in normal UPS operation.

CAUTION: If the plug or shorting wire is removed, the UPS system will be commanded to shut down. In typical applications, the plug will be wired to a remote normally closed dry contact to provide a short for normal operation. The remote dry contact could be opened to command the UPS to shut down in an emergency.

The 10-20kVA 3-phase UPS units come equipped with a Remote Emergency Power Off signal port, labeled REPO. These UPS units come equipped with a 4-pin plug wired to provide a short on pins 3 and 4 that results in normal UPS operation. This plug could be wired for a remote normally open REPO device or for a remote normally closed REPO device.



CAUTION: If the plug or default shorting wire is removed, the UPS system will be commanded to shut down. In typical applications, the plug will be wired to a remote normally closed dry contact to pins 3 and 4, to provide a short for normal operation or wired for a remote normally opened dry contact to pins 1 and 2 (requires shorting wire between pins 3 and 4). A remote normally open or normally closed dry contact could be used to command the UPS to shut down in an emergency. Refer to [Appendix H: 10 to 20kVA REPO Port Definition](#) for details.

DB9 Coms Port (RS232)

All units have a DB9 equipped with an RS232 serial communications port. This serial port is used for UPS core Firmware Updates.

USB Coms Port (USB)

All units include a USB serial communications port. This communication port is reserved for "Future Use".

Input Power Cord (INPUT)

Each UPS Model may have a unique power input connector, labeled INPUT. Refer to the corresponding Product Specification Sheet for detailed definition.

Chassis Ground Connection Point (⏚)

All units have a chassis ground connection, labeled with a ground symbol. This is used to ground the UPS and EBP chassis to the rack/cabinet for safety and proper grounding procedures.

Output Receptacles (GROUP1, GROUP2, GROUP3)

Each UPS Model has unique groups of power output connectors, labeled GROUP 1 and GROUP 2. Some UPS Models may also have a GROUP 3 outlet group. The following sections define typical output receptacles. Refer to the corresponding Product Specification Sheet for latest detailed definition.

EBP Connector (BATTERY CONNECTOR)

All units have an External Battery Pack (EBP) power connection to connect to an external battery pack. Each UPS Model has been calibrated to a specific EBP and EBP Operating Voltage. The EBP units are not interchangeable due to the operating voltage. The 5-10kVA single-phase VRLA UPS units utilize the 240Vdc (± 120 Vdc) EBP. The 10-20KVA 3-phase VRLA UPS units utilize the 480Vdc (± 240 Vdc) EBP. The 5-10kVA 1-Phase Lithium units utilize the 192Vdc Lithium EBP.

EBP Communications Connector (EBP COM)

The 5-10 kVA Lithium UPS units have a port labeled EBP COM required to connect a communications cable (RJ45) from the UPS to the EBP for battery management system communication, monitoring, and control.

Maintenance Bypass Signal Port (MAINT.)

All units have a Maintenance Bypass Signal port, labeled MAINT. This port is used to detect if the external Maintenance Bypass Switch breaker (P/N UMB20K) is in the opened or closed position/status. The opened position means that utility power is switched to be fed to the input of the UPS. The closed position means that all power has been removed from the UPS so it can be removed from the system to perform periodic maintenance. The external Maintenance Bypass Switch is supported on the 10-20kVA 3-Phase the 5-10kVA EU UPS units only.

- This port should be connected with a 2-pin MAINT plug with shorting wire installed for 10-20kVA units.
- This port should be connected with a 2-pin MAINT plug with shorting wire installed for 5-10kVA units when not in use with the MBS.
- This port should be connected with the MAINT sense cable when the MBS unit is present in the system.

Note: For 1-Phase 5-10kVA VRLA UPS units containing core system **FW v030 and earlier** the MAINT port should be normally unoccupied. System FW version can be found on the touch-screen display after the system is powered. This port should only be used on these units when placing the system in to Maintenance Bypass mode for maintenance.

Refer to the Installation Manual for MBS connection configurations.

Note: The MBS is not supported in a Parallel mode system.

Parallel Ports (PARALLEL 1, PARALLEL 2)

The 10-20kVA 3-Phase UPS units have two (DB15) parallel port connections (one male and one female). The 5-10kVA 1-Phase Lithium units have two (DB9) parallel port connections (one male and one female). These connections are used to wire the communications for two to four UPS units of the same rating in Parallel mode system. When configuring a parallel system, use the proper cables supplied with the UPS.

Dry Contacts (IN 1-8, OUT 1-8)

All 10-20kVA 3-Phase UPS units have four input and four output dry contact ports. Each dry contact port is across two dry contact connections (1 and 2, 3 and 4, 5 and 6, 7 and 8). These dry contact ports allow remote control (IN) and monitoring (OUT). These contacts are provisioned in the dry contact setup pages in [Section 2 – Front Panel Display](#) of this document.

Output Sensor Port (OUTPUT)

All 10-20kVA 3-Phase UPS units have an output sensor port. This port is used to detect the status of the external Maintenance Bypass Switch (P/N UMB20K) Output Breaker. This port should be unconnected when no external Maintenance Bypass Switch is present in the system and should be connected to the OUTPUT port on the MBS unit when the MBS unit is present in the system.

Note: The 1-Phase 5-10kVA UPS units do not have an output sensor port. If the MBS is used in conjunction with these units this output breaker sense feature will not be available.

RJ45 Port (RS485)

All 10-20kVA 3-Phase UPS units have an RS485 serial communications port. This communication port is reserved for “Future Use”.

Back-Feed Contacts (BACKFEED 1-4)

All 10-20kVA 3-Phase UPS units have Back-feed ports. These are dry contacts that indicate when the UPS is in the Battery state and the bypass relay is closed, which will feed the UPS output power back into the source. When this is detected, the UPS will

shut down and the back-feed dry contacts will be triggered. Pin 1 to 2 are normally open and will close when back-feed is triggered. Pin 3 to 4 are normally closed contacts that will open when back-feed is triggered.

Battery Temperature Sensor Port (BAT_T)

The 5-20kVA VRLA UPS units have a Battery Temperature Sensor port to connect to the first External Battery Pack (EBP) unit. This allows the UPS to monitor the EBP operating temperature environment to alter the battery charging parameter to extend battery life. It is recommended that the BAT_T cable be inserted for proper monitoring and usage. It is assumed that all EBP units connected to the same system are in the same environmental conditions. If this cable is not connected, an alarm will be triggered.

U05N11V / U05S11V

The 5kVA North American (NA) UPS unit has a permanently connected input power cord with an L6-30 plug. This unit has two groups of outlets. Group 1 (2x L6-30R) outlets are the main outlets. These outlets are not switchable and should contain the critical loads. Group 2 (2x L6-30R) are switchable outlets. These outlets may be used for non-critical loads. When the UPS is operating in the battery state, Group 2 outlets may be programmed to turn off earlier to conserve battery capacity for the Group 1 outlets.

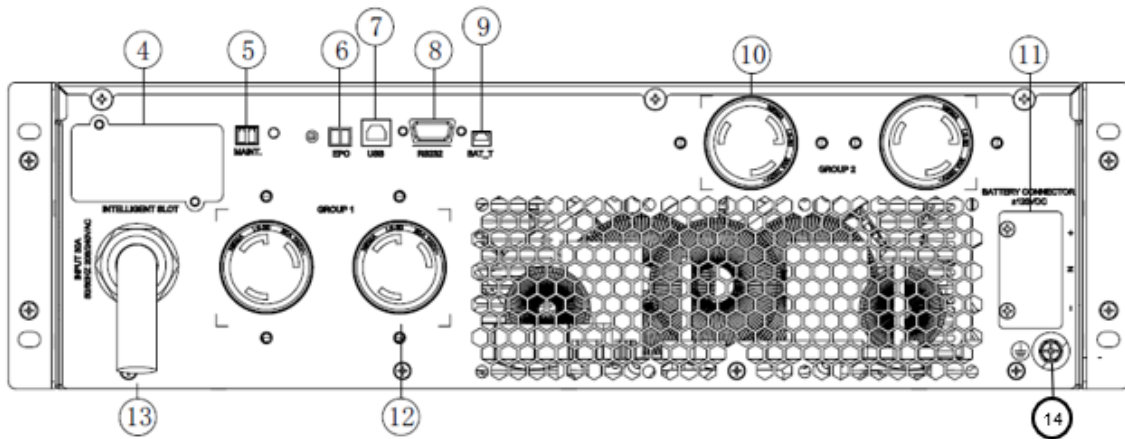

4. Intelligent Slot	8. DB9 Coms Port	12. Group 1 Outlets
5. Maint. Bypass Signal	9. Battery Temp. Port	13. Input Cord
6. EPO Signal Port	10. Group 2 Outlets	14. Ground Screw
7. USB Coms Port	11. EBP Connector	

Figure 6a: 5kVA North American Rear View (U05x11V)

U06N11V / U06S11V / U10N11V / U10S11V

The 6 and 10kVA NA UPS units have a terminal block for a hardwire connection on the input of the UPS. These units have two groups of outputs. Group 1 (hardwire connection) is the main non-switchable output. This output should contain the critical loads. Group 2 (2x L6-30R) are switchable outlets. These outlets may be used for non-critical loads. When the UPS is operating in the battery state, Group 2 outlets may be programmed to turn off earlier to conserve battery capacity for the Group 1 output.

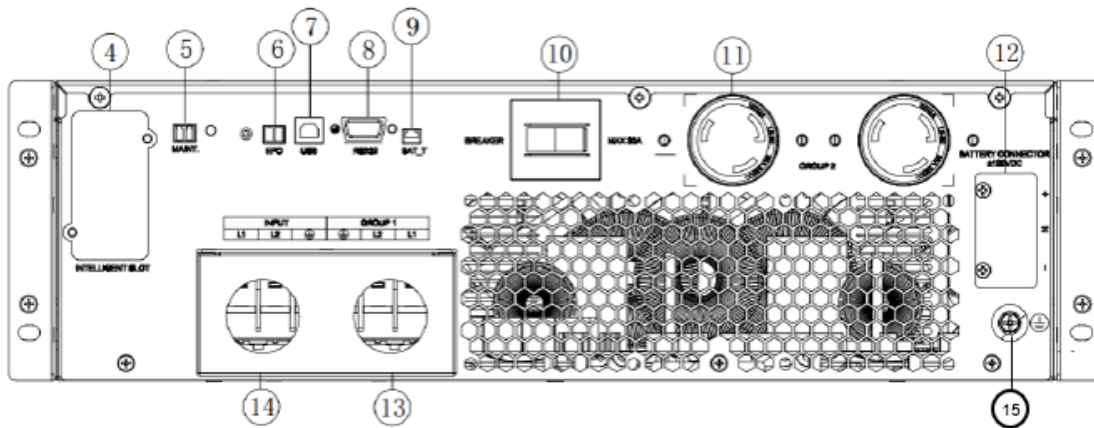

4. Intelligent Slot	8. DB9 Coms Port	12. EBP Connector
5. Maint. Bypass Signal	9. Battery Temp. Port	13. Group 1 Terminals
6. EPO Signal Port	10. Group 2 Breaker	14. Input Power Terminals
7. USB Coms Port	11. Group 2 Outlets	15. Ground Screw

Figure 6b: 6 and 10kVA North American Rear View (U06x11V / U10x11V)

U06N12V / U06S12V / U10N12V / U10S12V

The 6 and 10kVA EU UPS units have a terminal block for a hardwire connection on the input of the UPS. These units have three groups of outputs. Group 1 (hardwire connection) is the main non-switchable output. This output should contain the critical loads. Group 2 (2x C-13 with a 10A output breaker) are switchable outlets. These outlets may be used for non-critical loads. Group 3 (2x C-19 with a 16A output breaker) are switchable outlets. These outlets may be used for non-critical loads. When the UPS is operating in the battery state, Group 2 and 3 outlets may be programmed to turn off earlier to conserve battery capacity for the Group 1 output.

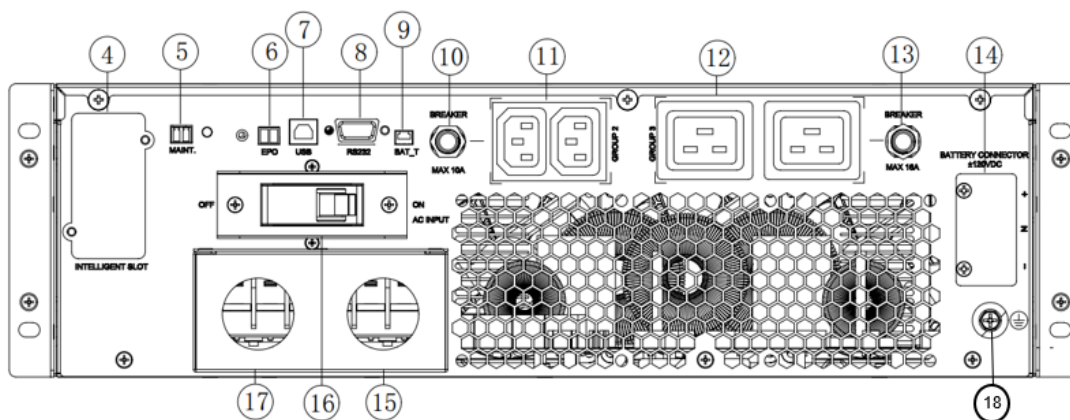

4. Intelligent Slot	10. Group 2 Breaker	16. Input Breaker
5. Maint. Bypass Signal	11. Group 2 Outlets	17. Input Power Terminals
6. EPO Signal Port	12. Group 3 Outlets	18. Ground Screw
7. USB Coms Port	13. Group 3 Breaker	
8. DB9 Coms Port	14. EBP Connector	
9. Battery Temp. Port	15. Group 1 Terminals	

Figure 6c: European 6 and 10kVA Rear View (U06x12V / U10x12V)

U05N11L / U05S11L

The 5kVA North American (NA) Lithium UPS unit has a permanently connected input power cord with an L6-30 plug. This unit has two groups of outlets. Group 1 (2x L6-30R) outlets are the main outlets. These outlets are not switchable and should contain the critical loads. Group 2 (2x L6-30R) are switchable outlets. These outlets may be used for non-critical loads. When the UPS is operating in the battery state, Group 2 outlets may be programmed to turn off earlier to conserve battery capacity for the Group 1 outlets.

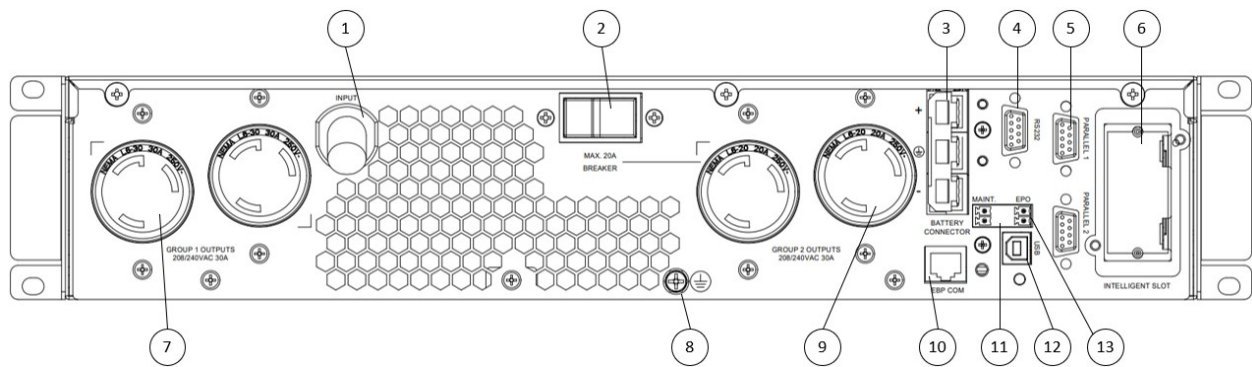

1. Input Cord (NEMA L6-30P)	6. Intelligent Card Slot	11. MAINT (Maintenance) Port
2. Group 2 Output Breaker (20A)	7. Group 1 Outputs (2x NEMA L6-30R)	12. USB Port (USB-B)
3. Battery Connector	8. Grounding Screw	13. EPO (Emergency Power Off) Port
4. RS232 Serial Port (DB9)	9. Group 2 Outputs (2x NEMA L6-20R)	
5. Parallel Ports 1 & 2 (DB9)	10. EBP Communication Port (RJ45)	

Figure 6d: 5kVA Lithium North American Rear View (U05x11L)

U06N11L / U06S11L / U10N11L / U10S11L

The 6 and 10kVA North American (NA) Lithium UPS units have a terminal block for a hardwire connection on the input of the UPS. These units have two groups of outputs. Group 1 (hardwire connection) is the main non-switchable output. This output should contain the critical loads. Group 2 (2x L6-30R) are switchable outlets. These outlets may be used for non-critical loads. When the UPS is operating in the battery state, Group 2 outlets may be programmed to turn off earlier to conserve battery capacity for the Group 1 output.

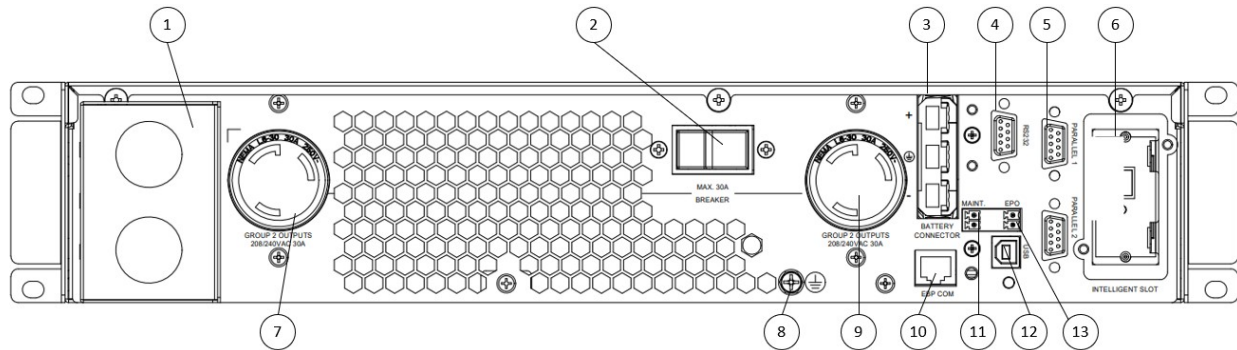

1. Input Connection Housing (Terminal Block access)	6. Intelligent Card Slot	11. MAINT (Maintenance) Port
2. Group 2 Output Breaker (30A)	7. Group 1 Outputs (1x NEMA L6-30R)	12. USB Port (USB-B)
3. Battery Connector	8. Grounding Screw	13. EPO (Emergency Power Off) Port
4. RS232 Serial Port (DB9)	9. Group 2 Outputs (1x NEMA L6-30R)	
5. Parallel Ports 1 & 2 (DB9)	10. EBP Communication Port (RJ45)	

Figure 6e: 6 and 10kVA Lithium North American Rear View (U06x11L / U10x11L)

⊕	L1	L2	L1	L2	⊕
INPUT			GROUP 1 OUTPUT		

Figure 6f: 6-10kVA 1-Phase NA Lithium Input/Output Terminal Block

[U05N12L / U05S12L / U06N12L / U06S12L / U10N12L / U10S12L](#)

The 5, 6, and 10kVA EU Lithium UPS units have a terminal block for a hardwire connection on the input of the UPS. These units have three groups of outputs. Group 1 (hardwire connection) is the main non-switchable output. This output should contain the critical loads. Group 2 (3x C-13 with a 10A output breaker) are switchable outlets. These outlets may be used for non-critical loads. Group 3 (2x C-19 with a 16A output breaker) are switchable outlets. These outlets may be used for non-critical loads. When the UPS is operating in the battery state, Group 2 and 3 outlets may be programmed to turn off earlier to conserve battery capacity for the Group 1 output.

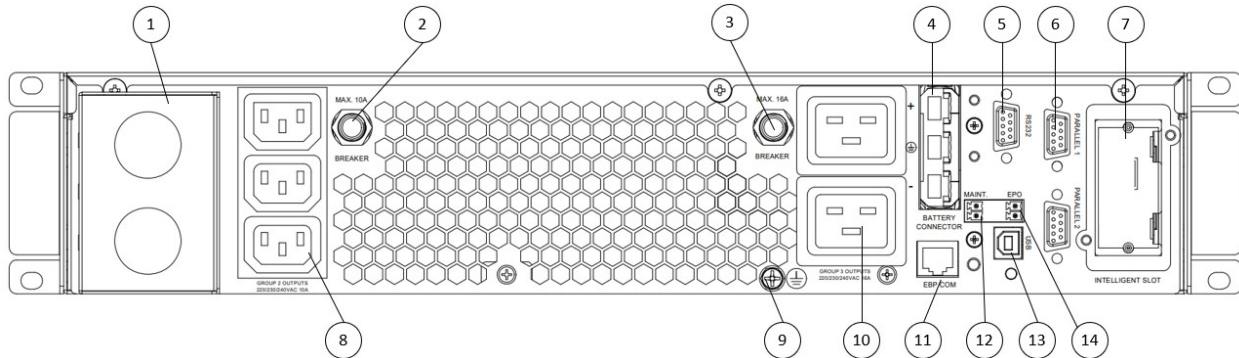

1. Input and Output Group 1 Connection Housing (Terminal Block access)	6. Parallel Ports 1 & 2 (DB9)	11. EBP Communication Port (RJ45)
2. Group 2 Output Breaker (10A)	7. Intelligent Card Slot	12. MAINT (Maintenance) Port
3. Group 3 Output Breaker (16A)	8. Group 2 Outputs (3x C13)	13. USB Port (USB-B)
4. Battery Connector	9. Grounding Screw	14. EPO (Emergency Power Off) Port
5. RS232 Serial Port (DB9)	10. Group 3 Outputs (2x C19)	

Figure 6g: European 5, 6, and 10kVA Rear View (U05x12L / U06x12L / U10x12L)

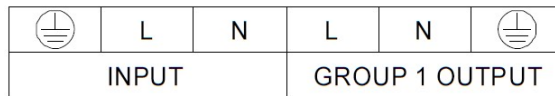
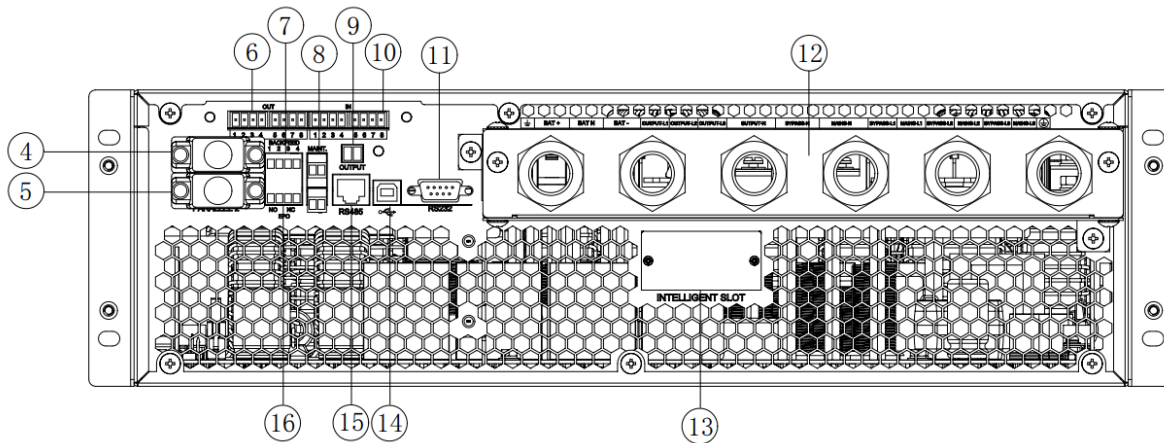

Figure 6h: 5-10kVA 1-Phase EU Lithium Input/Output Terminal Block

U10N32V / U10S32V / U15N32V / U15S32V / U20N32V / U20S32V

The 10 - 20kVA EU 3-phase UPS units have two groups of terminal blocks for a hardwire connection on the input of the UPS - one group for main input and the other group for bypass input. These units have one output group. The output is a hardwire connection and is non-switchable. The UPS could be configured and wired to have one 3-phase output or 3 separate single-phase outputs.



4. Parallel Port 1	9. Maint. BPS Output Brk Sig.	14. USB Comms Port
5. Parallel Port 2	10. Input Dry Contact Ports	15. RS485 Comms Port
6. Output Dry Contact Ports	11. DB9 Comms Port	16. REPO Port
7. Back-feed port	12. In/Out/Bat Terminal Block	
8. Maint. Bypass Signal	13. Intelligent Slot	

Figure 6i: European 10-20kVA 3-Phase Rear View (U10x32V / U15x32V / U20x32V)

⏚	BATTERY			OUTPUT				INPUT						⏚	
	BAT+	BAT N	BAT-	L1	L2	L3	N	BYPASS-N	INPUT-N	B1	L1	B2	L2		B3

Figure 6j: 10-20kVA 3-Phase Input/Output/Battery Terminal Block

UPS Accessories

VRLA External Battery Pack (UVP240, UVP480)

The VRLA External Battery Pack (EBP) has a positive-negative dual-battery structure. The single-phase 5-10kVA VRLA UPS units support a 240V battery pack and the 3-phase 10-20kVA VRLA UPS units support a 480V battery pack. Each battery pack has multiple battery cartridges that make up a battery cartridge set. These battery cartridges in the set are connected in series. The battery cartridge set for the 240V EBP has two battery cartridges with 8 batteries and one battery cartridge with 4 batteries for a total of 20 batteries connected in series. The battery cartridge set for the 480V EBP has four battery cartridges with 10 batteries in each cartridge for a total of 40 batteries connected in series. A total of three wires are connected to the UPS unit from the EBP unit, the positive and negative ends of the battery pack and a neutral that is connected to the center point of the series batteries.

The UPS comes with one EBP unit. Additional EBP units may be connect to the UPS to extend the runtime of the UPS when operating in the battery state. The 5-10kVA single-phase UPS units support up to five EBP units. The 10-20kVA 3-phase UPS units support up to eight EBP units. Additional EBPs are connected to the last EBP in the chain.

When an additional EBP is connected to the UPS the total Battery Group number must be appropriately set. All relevant settings may be performed through the WebUI or the Front Panel Display.



Warning!

Ensure that the polarities are correctly connected to the UPS unit and to subsequent EBP units. The battery cartridges cannot be mixed. Please use the Panduit recommended battery cartridge sets (P/N UVD240 or P/N UVD480) for the appropriate EBP. Battery cartridges must be changed in sets. Do not mix old and new battery cartridges.

VRLA Battery Cartridge Set (UVD240, UVD480)

The battery cartridge sets for the VRLA EBP units contain either three or four cartridges that make up the appropriate voltage for the specific EBP unit. Panduit recommends changing all the battery cartridges in a system at the same time. Do not mix new battery cartridges with old battery cartridges in the system. If you have multiple EBPs in your system, then you should change the battery cartridge sets in all the EBP units in that system. The following table provides the battery cartridge set part numbers that must be used with the specific EBP part numbers.

EBP Unit SKU	Battery Cartridge Set SKU
UVP240	UVD240
UVP480	UVD480

Lithium External Battery Pack (UVPL12H)

The Panduit single-phase 5-10kVA Lithium UPS units support connection with the Panduit 192 Vdc Lithium-Ion external battery pack (UVPL12H). The EBP contains sets of LiFePO4 cells connected in series for a total voltage of 192 Vdc. Four of these sets are connected in parallel to give an energy capacity of 12Ah per EBP.

Note: The Lithium EBP does not contain replaceable internal cartridges. When a new battery is

required, the entire EBP must be replaced. Replacement of the Lithium EBP must be with the same part number.

The battery connection cable consists of three power wires, a positive and negative end and a grounding wire that are connected to the UPS unit from the EBP unit. Additionally, an RJ45 cable for BMS communication is connected between the EBP COM port on the UPS and a COM port on the rear panel of the EBP.

The front panel of the EBP contains status LEDs indicating the running status, warning alarms, and capacity.

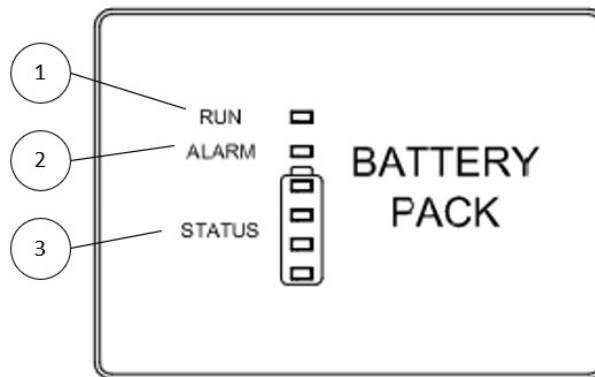

1. RUN – displays as green if the EBP is running normally.
2. ALARM – Off when in normal operation. Displays as RED if there is an issue with the EBP or configuration.
3. STATUS – Indicates the charged capacity of the EBP. If the battery is fully charged all four lights will be illuminated solid green. As a discharged battery becomes charged, these lights will illuminate from the bottom to the top approximating 25% intervals. (0-25%, 26-50%, 51-75%, 76-100%)

The 5-10kVA Lithium UPS comes with one EBP unit. A total of four EBP units may be connected to the UPS to extend the runtime when operating in the battery state. Additional EBPs are connected to the last EBP in the chain through the battery connector as well as the COM and CAN ports to synchronize the controls and BMS system. Each EBP includes one RJ45 COM and one RJ45 CAN cable. Each EBP added to the system must have a unique address ID assigned to it through configuration of the DIP switches labeled ADD on the rear panel.

Note: After initial installation and powering of the UPS it may take a few moments for the EBPs to synchronize communication with the UPS and engage the internal power relay to begin charging.

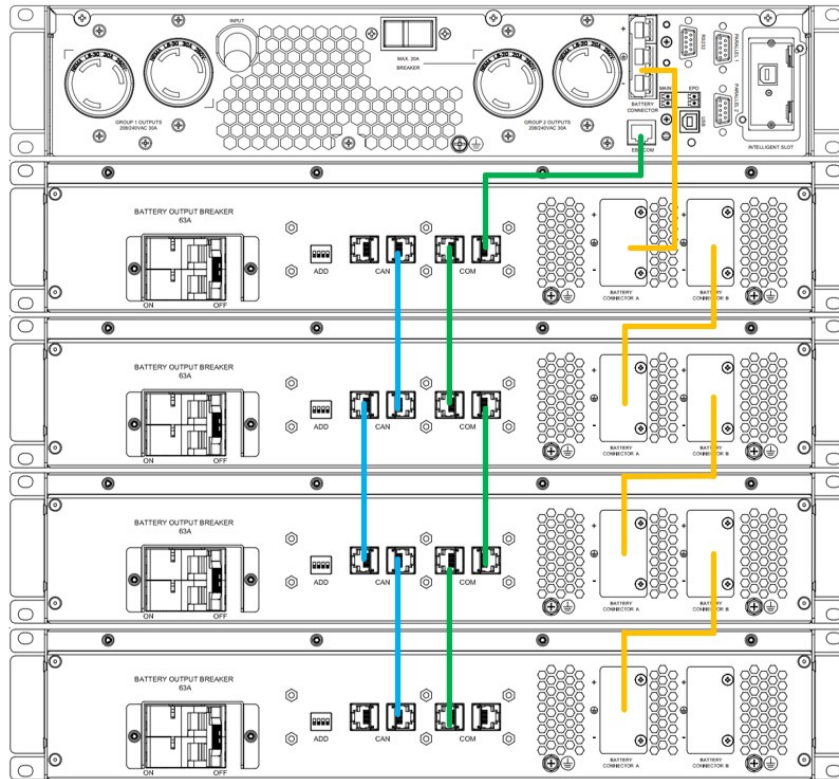

Figure 7a: 5-10kVA Lithium UPS with Four EBPs Connection Diagram

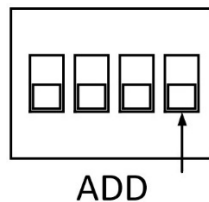

Figure 7b: Lithium EBP Address DIP switch

Maintenance Bypass Switch (UMB20K)

The Maintenance Bypass Switch is an optional 3 RU unit that allows the 3-phase and 1-Phase 5-10kVA (EU region only) UPS to be removed from the system without powering down the load. The 3-Phase UPS has two sensor ports. The MAINT port allows the UPS to monitor the Maintenance Switch lock (on CB 3). The OUTPUT port allows the UPS to monitor the output breaker (CB 4) in the Maintenance Bypass Switch unit.

Note: The 1-Phase 5-10kVA UPS units only have a MAINT port. The OUTPUT breaker

sense will not be used with the MBS in this configuration.

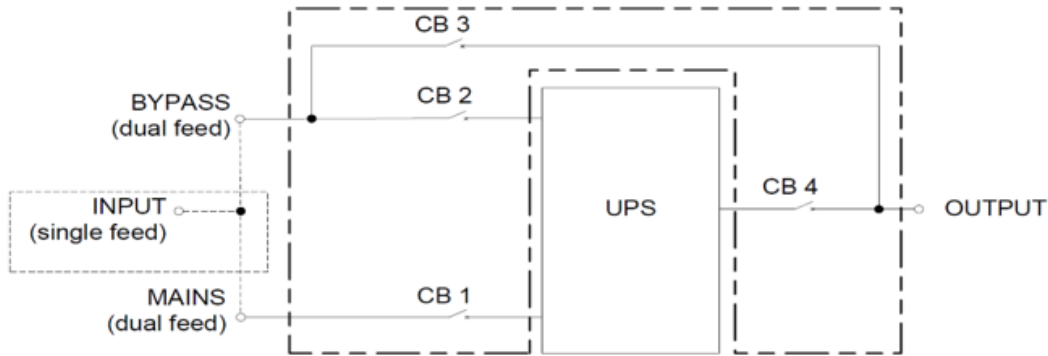



Figure 8: High-level Maintenance Bypass Switch Block Diagram

Network Card (UNCP01)

The network card comes installed in the “N” type model UPS units (ex. U05N11V, U10N12V, U20N32V, etc.). Refer to the SmartZone UPS Network Management Card User Manual for monitoring and controlling the UPS through the Network card. The “S” type model UPS units (ex. U05S11V, U10S12V, U20S32V, etc.) may be field upgradable with a network card or a relay card.

 **CAUTION!** DO NOT TOUCH THE NETWORK CARD WITHOUT PROPER ESD PROTECTION.

To install or remove the Network card, remove and retain the two #0 Phillips screws in the mounting holes labeled 7 in the below figure. If no network card is in the unit, the Intelligent Slot will have a blanking plate over the slot. Remove the blanking plate or card.

Note: There are card slide guides in the slot that the card must be slid into for proper installation of the card. After installing the card secure with the two #0 Phillips screws that were removed.

Network Card Hardware Features



Figure 9: Network Card Front View

1. Ethernet Connection	4. Status LEDs	7. Mounting holes
2. Sensor Connection	5. Reset button	
3. MAC ID Label	6. Micro USB Connection	

Ethernet Connection

Connect the ethernet port on the Network card to an ethernet switch or router using a standard Cat 5E or Cat 6 ethernet patch cord.

Sensor Connection

Connect the supports Panduit environmental sensors and/or sensor hub with the cables provided in the sensor installation kit.

Note: This port is for Panduit sensor accessories only.

MAC ID Label

The MAC ID of the wired ethernet port is listed on the label on the faceplate of the Network card. The MAC ID is unique to the specific Network card. The above figure shows an example of the MAC ID.

Status LEDs

The red status LED turns on automatically as soon as power is applied. After the Network card initializes, the firmware in the Network card takes control of these LEDs. In general, the green LED indicates power to the Network card and the red LED indicates a fault or initialization of the Network card.

Reset Button

A pin hole is provided in the faceplate of the Network card to access the reset button using a paper clip or similar device. The reset behavior of the Network card is described below and is dependent on the duration of the button press.

Reset the NMC when it does not respond: Hold the reset button for 2 seconds and release when green LED starts flashing. This will cause a reset of the NMC controller, but the entire configuration will be retained.

Reset all configurations to a factory default setting: Hold the reset button for at least 20 seconds and release when green LED starts flashing fast. This will cause a reset of the NMC controller and all configurations to be erased, including the usernames and passwords.

Micro USB Connection

The USB connector provides a COM port connection for configuration via a command line interface (CLI) to the Network card.

Refer to the Network card User's Manual for more details on the operations of the Network card.

Relay Card (URC005)

The intelligent slot on the UPS unit may accept either the Relay card or the Network card, not both. The Relay card is not supported in the 3-phase UPS units since these units have built-in dry contact points. Follow the steps in the **Network Card (UNCP01)** section to install or remove the Relay card from the UPS unit.

 **CAUTION!** DO NOT TOUCH THE RELAY CARD WITHOUT PROPER ESD PROTECTION.

The 12-pin relay card allows the user to monitor specific status on the UPS. The predefined monitoring contact points on the relay card change state when the status in the UPS changes state.

Terminal NO.	Terminal function	Description
1	Common source	common point for all contacts on the relay card
2	UPS ON = Open	When the UPS is switched ON, Pin 1 to Pin 2 would change from NC (Normal Closed) to Open.
3	AC fail = Open	When the input utility power fails, Pin 1 to Pin 3 would change from NC (Normal Closed) to Open.
4	AC fail = Close	When the input utility power fails, Pin 1 to Pin 4 would change from NO (Normal Opened) to Close.
5	Batt low = Open	When the battery voltage is low, Pin 1 to Pin 5 would change from NC (Normal Closed) to Open.
6	Batt low = Close	When the battery voltage is low, Pin 1 to Pin 6 would change from NO (Normal Opened) to Close.
7	UPS alarm = Open	When the UPS has an alarm, Pin 1 to Pin 7 would change from NC (Normal Closed) to Open.
8	UPS alarm = Close	When the UPS has an alarm, Pin 1 to Pin 8 would change from NO (Normal Opened) to close.
9	Bypass active = Open	When the UPS is working in the Bypass state, Pin 1 to Pin 9 would change from NC (Normal Closed) to Open.
10	Bypass active = Close	When the UPS is working in the Bypass state, Pin 1 to Pin 10 would change from NO (Normal Opened) to Close.
11	UPS fault = Open	When the UPS has a fault, Pin 1 to Pin 11 would change from NC (Normal Closed) to Open.
12	UPS fault = Close	When the UPS has a fault, Pin 1 to Pin 12 would change from NO (Normal Opened) to Close.

The relay card contains eleven dry contact outputs plus a common lead. The outputs are factory programmed according to the functions listed in the table above.

The relay card must be removed from the UPS intelligent slot to access the screws for connecting the remote monitoring devices.



Figure 10: Relay Card Front and Top View (showing connection points)

5kVA 208 to 120 VAC Step-Down Transformer (UTFMRDU)

The Panduit 5kVA 208 to 120 VAC Step-Down Transformer (UTFMRDU) is only for use with 5-10kVA Single Phase NA region UPS models. It is a 2RU rack mounted accessory unit. It contains a NEMA L6-30P input plug to convert a 208 VAC L6-30R outlet receptacle on the NA 5-10kVA UPS models to 120 VAC NEMA 5-20R outlet receptacles to support equipment requiring 120 VAC. The maximum rated power capacity for this device is 5kVA.

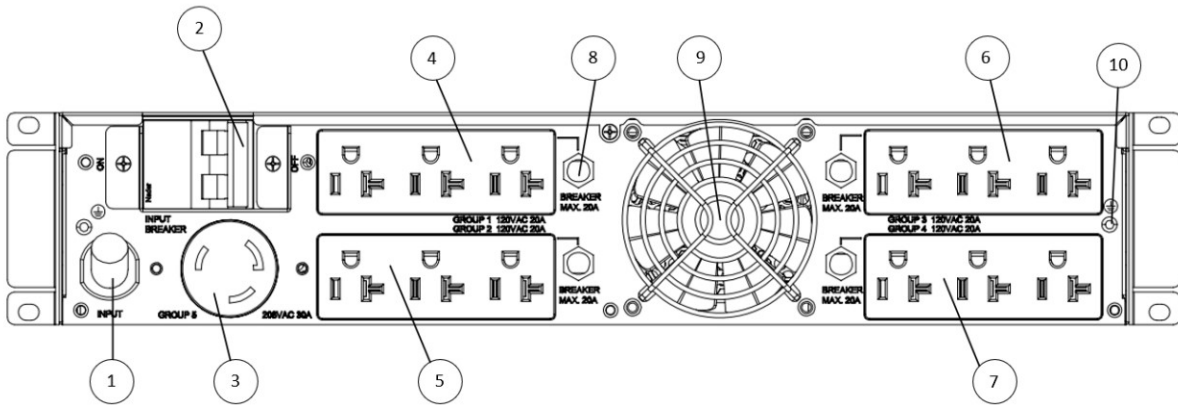

Figure 11: Rear Panel of 5kVA 208 to 120 VAC Step-Down Transformer (UTFMRDU)

1. Input Cord	2. Input Breaker	3. L6-30R Output (Group 5)	4. NEMA 5-20R Group 1 Output (120 VAC)
5. NEMA 5-20R Group 2 Output (120 VAC)	6. NEMA 5-20R Group 3 Output (120 VAC)	7. NEMA 5-20R Group 4 Output (120 VAC)	8. Output Breaker (20 A, push button reset)
9. System Cooling Fan	10. Ground Attachment Screw		

Refer to the Panduit.com website for more item details, user manual, and installation guide.

Section 2 – Front Panel Display

The front panel display contains four color icon LEDs, a 3.5-inch color touch screen display, and a power ON button.

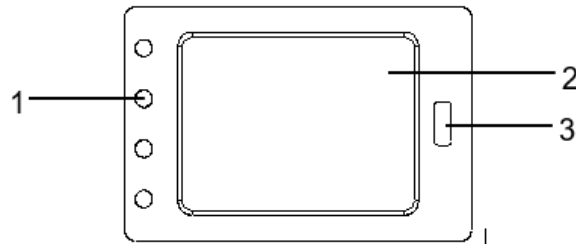

Figure 12: Front Panel Display (screen)

1. Status LEDs (from top to bottom: Alarm, Bypass, Battery, Normal)
2. Touch Screen Display
3. Power ON Button

Status LED Indicators

The status of the UPS system may be quickly identified through the following LEDs on the front panel display. The following table provides the descriptions of the four system LEDs.

Number	LED Icon	LED Name	Description
1		Alert	Yellow: UPS Warning Alert Red: UPS Critical Alert
2		Bypass	Blue: UPS is in the bypass state
3		Battery	Yellow: UPS is in the battery state
4		Normal	Green: UPS is operating the normal state with AC input power

Turning ON/OFF the UPS

Starting the UPS on Main Input Power



CAUTION! MAKE SURE THE INPUT SOURCE IS NOT ENERGIZED!



CAUTION! MAKE SURE GROUNDING IS PROPERLY CONNECTED!

1. Connect the input of the UPS to a known good source.
2. Make the appropriate connections (for both the Main and Bypass if applicable) to a known good source. **Note:** Main and Bypass may or may not be connected to the same source.
3. Make the appropriate connections to known good load(s).
4. Energize the known good source.
5. The UPS will auto start when a good source is provided.
6. Upon initial powerup it is recommended to fully charge the battery or EBP in order to supply the full rated backup time.

Cold Starting the UPS (Start the UPS on Battery)

1. Set the Battery Breakers (all breakers must be ON) to the “ON” position.
2. Ensure that all the Input and Output breakers on the UPS are in the “ON” position.
3. Press and hold the ON button for more than 6 seconds to turn ON the UPS power.
- 14.

Note: 5-10kVA Lithium UPS units must be initialized with Main Input Power to communicate with the EBP battery management system prior to cold-starting. The Lithium EBP capacity must then be above 10% for Cold Start to function.

Starting a 3-Phase UPS with an Optional Maintenance Bypass Switch Unit



CAUTION! MAKE SURE GROUNDING IS PROPERLY CONNECTED!

1. Make sure that the MAINTENANCE breaker and OUTPUT breaker signals are properly connected from the MBS to the UPS. Sense cables for MAINT and OUTPUT are included with the MBS and should be attached to their respective ports in the rear panels of the UPS and MBS.

2. Set the Battery Breaker to the “ON” position.
3. Turn ON BYPASS breaker and MAIN breaker.
4. Turn ON OUTPUT breaker
5. If the Rectifier input is within voltage range, the rectifier will start up in 60 seconds followed by the inverter.

Switching to the Internal Bypass State

1. While the UPS is operating in Normal Mode, turn OFF the Inverter via the Web UI or the front panel display to switch the UPS to the Bypass state.

Note: The power is not conditioned by the UPS when the UPS is in the internal Bypass state.

Note: The load is not protected from power loss when the UPS is in the internal Bypass state.

Note: Output short circuit protection is not supported in the internal Bypass state. A short circuit on the output at this time could damage the UPS.

Switching the 3-Phase UPS to the Maintenance Bypass State (with the Optional Maintenance Bypass Switch Unit - MBS)

1. Make sure that the MAINTENANCE breaker and OUTPUT breaker signals are properly connected from the MBS to the UPS. Sense cables for MAINT and OUTPUT are included with the MBS and should be attached to their respective ports in the rear panels of the UPS and MBS.
2. Remove the locking cover plate over the MAINTENANCE breaker (on the MBS). The UPS automatically switches to the internal Bypass state.
3. Switch ON (from down to up) the MAINTENANCE breaker on the MBS that bypasses the UPS unit.
4. Turn OFF the Battery breakers on the EBP(s) connected to the UPS.
5. Switch OFF (from up to down) the MAINS breaker on the MBS that feeds the input to the UPS unit.
6. Switch OFF (from up to down) the BYPASS breaker on the MBS that feeds the input to the UPS unit.
7. Switch OFF (from up to down) the OUTPUT breaker on the MBS from the output of the UPS unit.
8. At this point the UPS is totally isolated from the system and the MBS source is supplying power to the load through the MAINTENANCE breaker.

Note: Wait for about 30 minutes for the internal DC bus capacitors to be completely discharged, before opening the UPS enclosure for period maintenance by qualified personnel.

Switching the 3-Phase UPS to Normal Mode from the Maintenance Bypass State through the MBS

Note: Never attempt to switch the UPS back to Normal Mode until it is verified that there are no internal UPS faults.

1. Switch ON (from down to up) the OUTPUT breaker on the MBS to connect the output of the UPS unit to the load.
2. Switch ON (from down to up) the BYPASS breaker on the MBS to connect the input source to the input bypass on the UPS unit.
3. The UPS starts powering the load from the internal Bypass in parallel with the Maintenance Bypass and the bypass LED on the UPS will turn ON.
4. Switch ON the Battery breakers on the EBP(s) connected to the UPS.
5. Switch ON (from down to up) the MAINS breaker on the MBS to connect the input source to the main input on the UPS unit.
6. Switch OFF (from up to down) the MAINTENANCE breaker on the MBS. The load is fully supplied by the internal Bypass of the UPS unit.
7. Reinstall the cover plate on the MAINTENANCE breaker.
8. The rectifier will start operating normally after 30 seconds. If the inverter is working normally, the system will automatically switch from internal Bypass state to Normal state.

Shutting Down the 3-Phase UPS



CAUTION! This procedure should be followed to completely shut down the UPS and the Load. Not until all power switches, isolators and circuit breakers are opened will there be no output.

1. Switch OFF the Battery breakers on all the EBP units connected to the system.
2. Switch OFF (from up to down) the MAINS breaker on the MBS. If there is no MBS, then the breaker must be switched OFF at the power distribution panel, feeding the main input to the UPS unit.
3. Switch OFF (from up to down) the BYPASS breaker on the MBS. If there is no MBS, then the breaker must be switched OFF at the power distribution panel, feeding the bypass input of the UPS unit. The UPS shuts down.
4. Switch OFF (from up to down) the OUTPUT breaker on the MBS if one is in the system. This will isolate the load bus from the UPS unit.
5. To completely isolate the UPS from AC Input Main, the user either needs an MBS unit that is operating in Maintenance Bypass state, or all input breakers (Main and Bypass) in the power distribution panel from the utility shall be turned OFF, and a lockout tagout device should be placed on the power distribution panel feeding the UPS.

Note: Wait for about 30 minutes for the internal DC bus capacitors to be completely discharged, before opening the UPS enclosure for period maintenance by qualified personnel.

Starting a 1-Phase 5-10kVA UPS (EU region only) with an Optional Maintenance Bypass Switch Unit:



CAUTION! MAKE SURE GROUNDING IS PROPERLY CONNECTED!

1. The MAINS breaker on the MBS will remain OFF in this configuration. See Installation Manual for further details.
2. Set the Battery Breaker to the “ON” position.
3. Verify that the MAINT port between the UPS and MBS is properly connected using the MAINT cable included with the MBS.
Note: 1-Phase 5-10kVA VRLA UPS units operating with system **FW v030 or earlier** will not have the MAINT port normally occupied. System FW version may be located on the touch-screen display after powering the UPS.
4. Turn ON BYPASS breaker.
Note: The MAINS breaker will not be used with this configuration and should remain in the open position (switched down). Refer to installation manual for further details.
5. Turn ON OUTPUT breaker
Note: There is no OUTPUT port on the 5-10kVA UPS units. The output breaker sense on the MBS will not be used in this configuration.
6. If the Rectifier input is within voltage range, the rectifier will start up in 60 seconds followed by the inverter.

Switching the 1-Phase 5-10kVA UPS (EU region only) to the Maintenance Bypass state (with the optional Maintenance Bypass Switch Unit - MBS):

1. Make sure that the MAINTENANCE breaker signal cable is properly connected from the MBS to the UPS. The sense cable for MAINT is included with the MBS and should be attached to the respective ports in the rear panels of the UPS and MBS.

Important: 1-Phase 5-10kVA UPS units operating with system **FW v030 or earlier**, will not have the MAINT port normally occupied. FW versions may be verified on the touch-screen display. To enter Maintenance Bypass Mode, the MAINT sense cable or terminal shorting plug will have to be inserted first. Failure to do so may result in damage to the UPS.

2. Remove the locking cover plate over the MAINTENANCE breaker on the MBS. The UPS automatically switches to the internal Bypass state. “Maint Bypass” should be displayed on the screen.
3. Switch ON (from down to up) the MAINTENANCE breaker on the MBS that bypasses the UPS unit.
4. Turn OFF the Battery breakers on the EBP(s) connected to the UPS.
5. Switch OFF (from up to down) the BYPASS breaker on the MBS that feeds the input to the UPS unit.
6. Switch OFF (from up to down) the OUTPUT breaker on the MBS from the output of the UPS unit.
7. At this point the UPS is totally isolated from the system and the MBS source is supplying power to the load through the MAINTENANCE breaker.

Note: Wait for about 30 minutes for the internal DC bus capacitors to be completely discharged, before opening the UPS enclosure for period maintenance by qualified personnel.

Switching the 1-Phase 5-10kVA UPS (EU region only) to Normal Mode from the Maintenance Bypass state through the MBS

Note: Never attempt to switch the UPS back to Normal Mode until it is verified that there are no internal UPS faults.

1. Switch ON (from down to up) the OUTPUT breaker on the MBS to connect the output of the UPS unit to the load.
2. Switch ON (from down to up) the BYPASS breaker on the MBS to connect the input source to the input bypass on the UPS unit.
3. The UPS starts powering the load from the internal Bypass in parallel with the Maintenance Bypass and the bypass LED on the UPS will turn ON.
4. Switch ON the Battery breakers on the EBP(s) connected to the UPS.
5. Switch OFF (from up to down) the MAINTENANCE breaker on the MBS. The load is fully supplied by the internal Bypass of the UPS unit.
6. Reinstall the cover plate on the MAINTENANCE breaker.

Important: For 5-10kVA UPS units containing core system **FW v030 or earlier** the MAINT cable or shorting plug will have to be removed after reinstalling the cover plate.

7. The rectifier will start operating normally after approximately 30 seconds. If the inverter is working normally, the system will automatically switch from internal Bypass state to Normal state.

Shutting Down the 1-Phase UPS



CAUTION! This procedure should be followed to completely shut down the UPS and the Load. Not until all power switches, isolators and circuit breakers are opened will there be no output.

1. Switch OFF the Battery breakers on all the EBP units connected to the system.
2. Verify the MAINS breaker on the MBS is off if one is in use (down position).
3. Switch OFF (from up to down) the BYPASS breaker on the MBS. If there is no MBS, then the breaker must be switched OFF at the power distribution panel, feeding the bypass input of the UPS unit. The UPS shuts down.
4. Switch OFF (from up to down) the OUTPUT breaker on the MBS if one is in the system. This will isolate the load bus from the UPS unit.
5. To completely isolate the UPS from AC Input Main, the user either needs an MBS unit that is operating in Maintenance Bypass state, or all input breakers (Main and Bypass) in the power distribution panel from the utility shall be turned OFF, and a lockout tagout device should be placed on the power distribution panel feeding the UPS.

Note: Wait for about 30 minutes for the internal DC bus capacitors to be completely discharged, before opening the UPS enclosure for period maintenance by qualified personnel.

Display Operations

The display has several pages. There is a menu structure to access all the pages through the front panel display. This section describes the details of each page.

Menu Structure

5-10kVA Single-Phase VRLA UPS Menu Structure

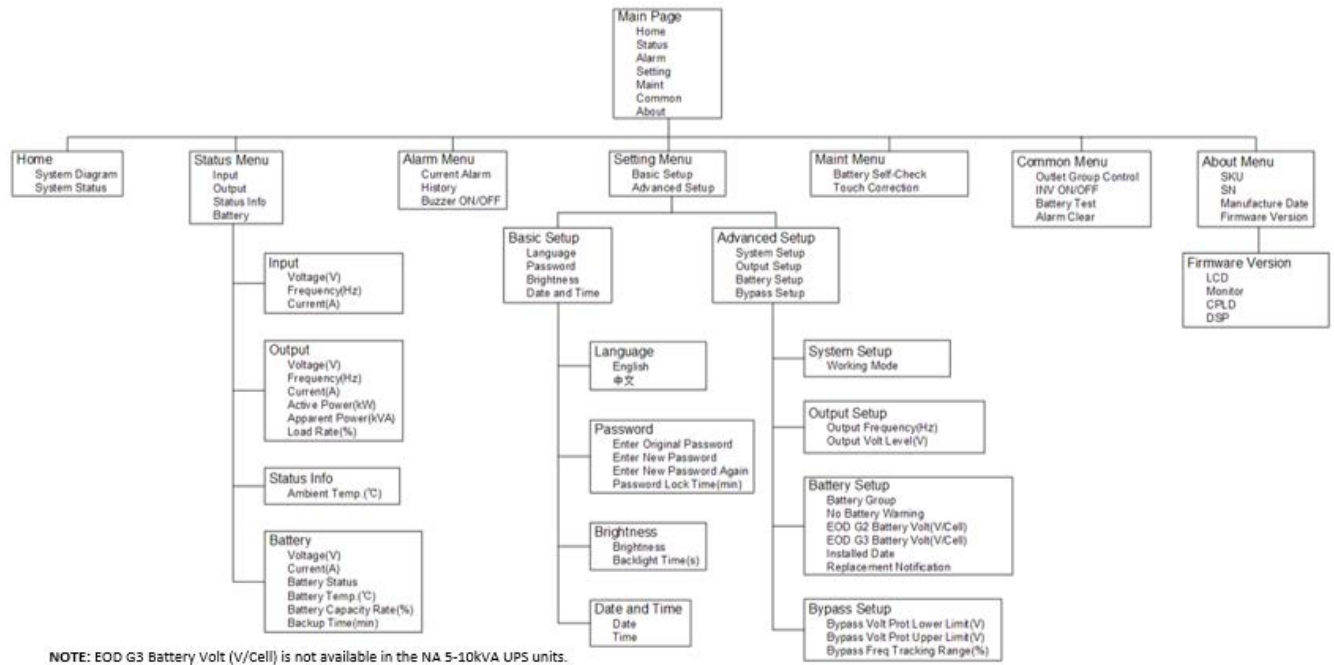

Figure 13a: 5-10kVA Single-phase VRLA UPS Menu Structure

5-10kVA Single-Phase Lithium UPS Menu Structure

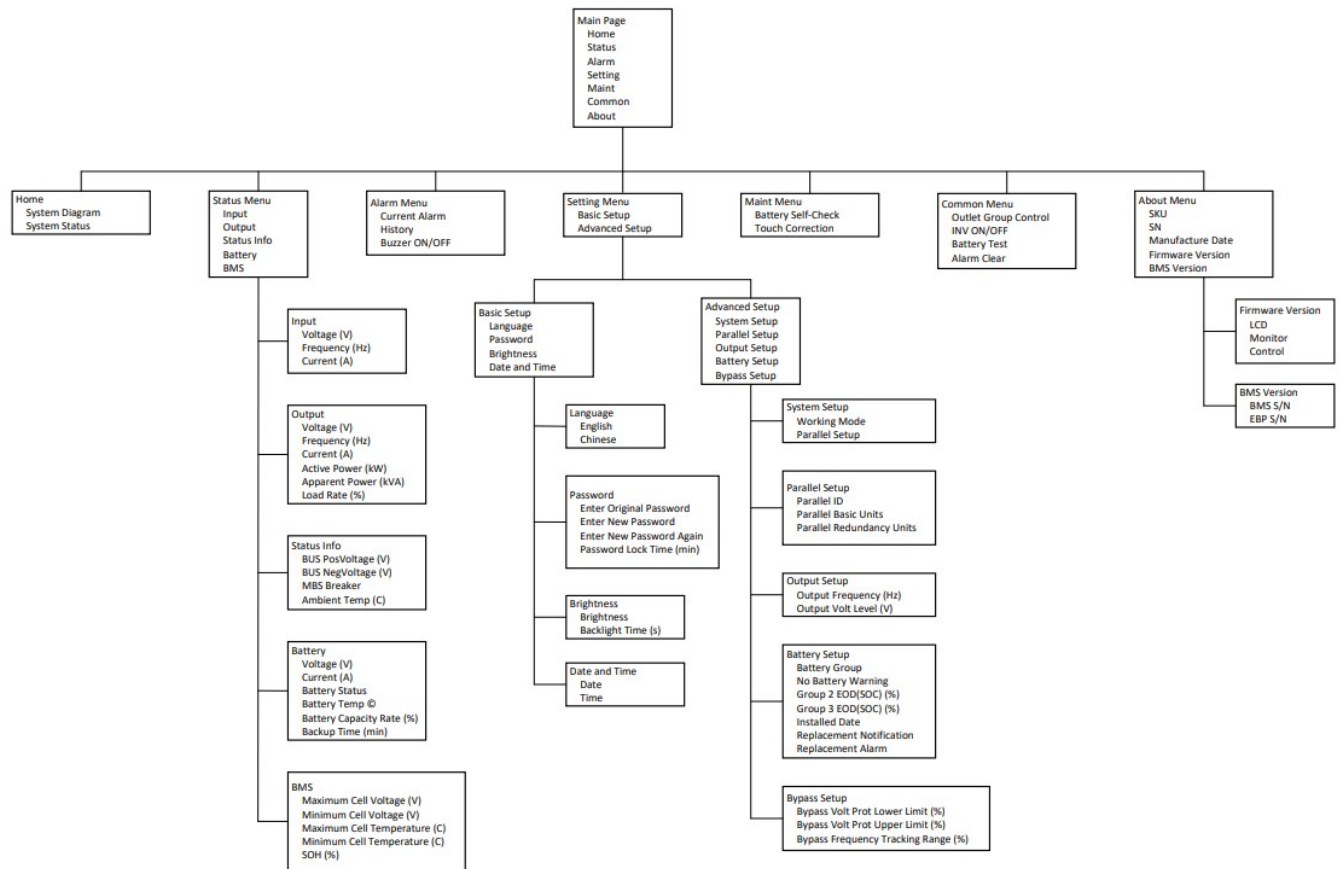

Figure 13b: 5-10kVA Single Phase Lithium UPS Menu Structure

10-20kVA 3-Phase UPS Menu Structure

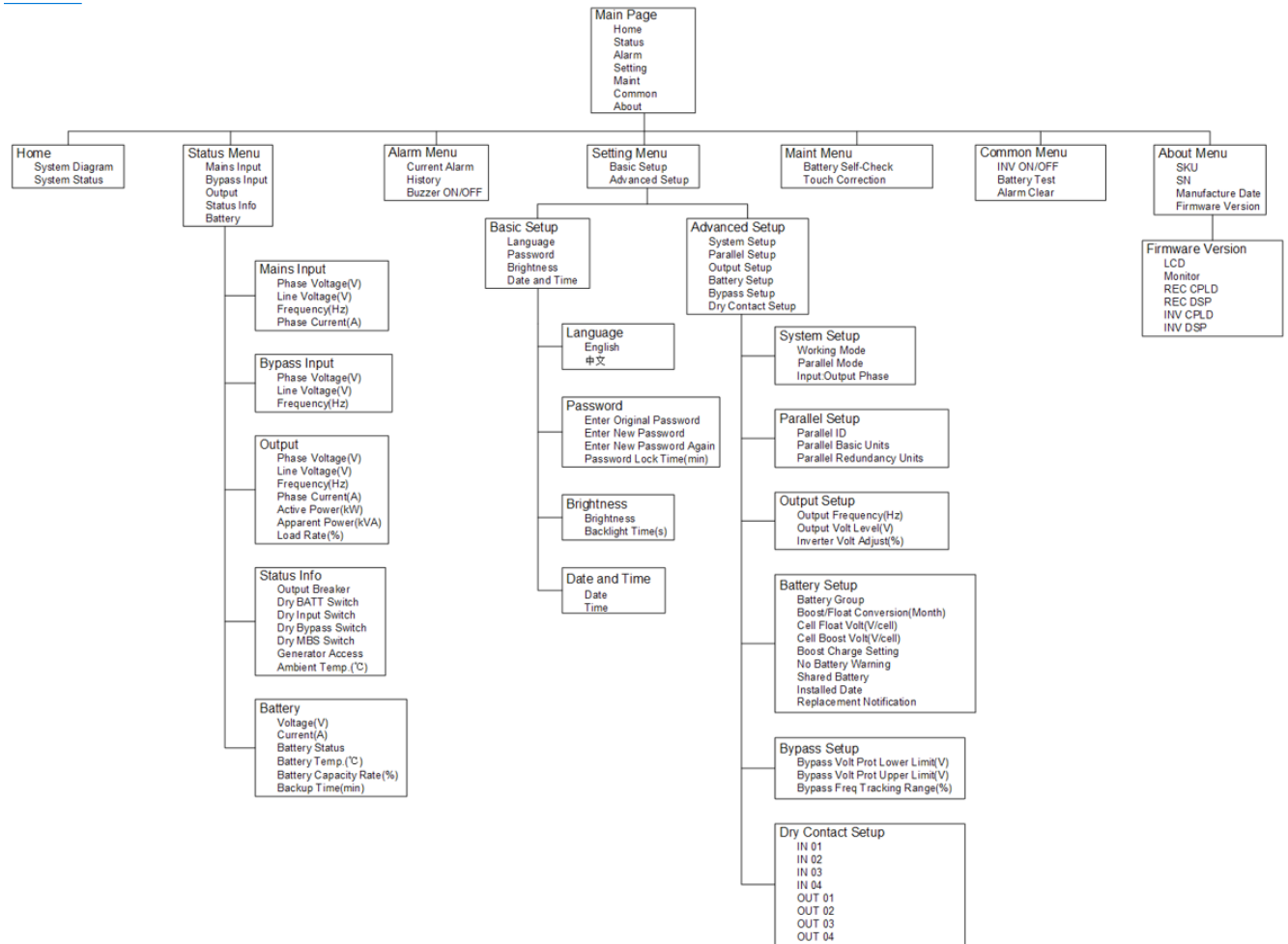















Figure 13c: 10 – 20kVA 3-Phase UPS Menu Structure

Display Icons

Number	Icon	Description
1		Status Icon: When pressed, goes to the Status Menu page.
2		Alarm Icon: When pressed, goes to the Alarm/Current/Warning/Event page.
3		Warning Icon: When pressed, goes to the Alarm/Current/Warning/Event page.
4		Event Icon: When pressed, goes to the Alarm/Current/Warning/Event page.
5		AC Input Icon: This icon represents the input circuitry; it will turn green on the home page when active. When pressed, goes to the Input Status page.
6		Bypass Input Icon: This icon represents the bypass input circuitry. It will turn green on the home page when active. When pressed, goes to the Bypass Input Status page. (10-20kVA 3-phase UPS units only).
7		Rectifier Icon: This icon represents the AC to DC rectifier circuitry. It will turn green on the home page when active.
8		Inverter Icon: DC to AC inverter circuitry will turn green on the home page when active.
9		Bypass Icon: Bypass circuitry will turn green on the home page when active.

Number	Icon	Description
10		AC Output Icon: Output circuitry will turn green on the home page when providing power to the load. When pressed, goes to the Output Status page.
11		Load Icon: The approximate load capacity percentage is indicated by the number of load bar sections illuminated. Each bar represents 25% of the load capacity.
12		Battery Icon: Indicates the battery charge status. Each incremental 25% bar is solid ON when charged or will blink ON and OFF when charging. When pressed, goes to the Battery Status page.
13		Next Icon: When pressed, goes to next page in that category.
14		Previous Icon: When pressed, goes to previous page in that category.
15		Return Icon: When pressed, returns to the top level page in that category.
16		Home Icon: When pressed, goes to the Home page. Except from the dashboard page, then it goes to the Status Menu page.
17		Home Page Icon: When pressed, goes to the Home page.
18		Status Menu Page Icon: When pressed, goes to the Status Menu page.

Number	Icon	Description
19		Alarm Menu Page Icon: When pressed, goes to the Alarm Menu page.
20		Setting Menu Page Icon: When pressed, goes to the Setting Menu page.
21		Maintenance Menu Page Icon: When pressed, goes to the Maintenance Menu page.
22		Common Menu Page Icon: When pressed, goes to the Common Menu page.
23		About Page Icon: When pressed, goes to the About page. Provides information about the UPS unit.
Note: The icons on the front panel display may vary depending on the installed firmware version.		

Initialization Page

As the UPS unit powers up and initializes, the screen will show the SmartZone UPS initialization page.



Figure 14: UPS Initialization Page on the Front Panel Display

Home Pages

After initialization is complete, the screen automatically transitions to the home page.

Home Page

The home page contains all the key information that the user needs for a quick view of the operating status of the UPS system.

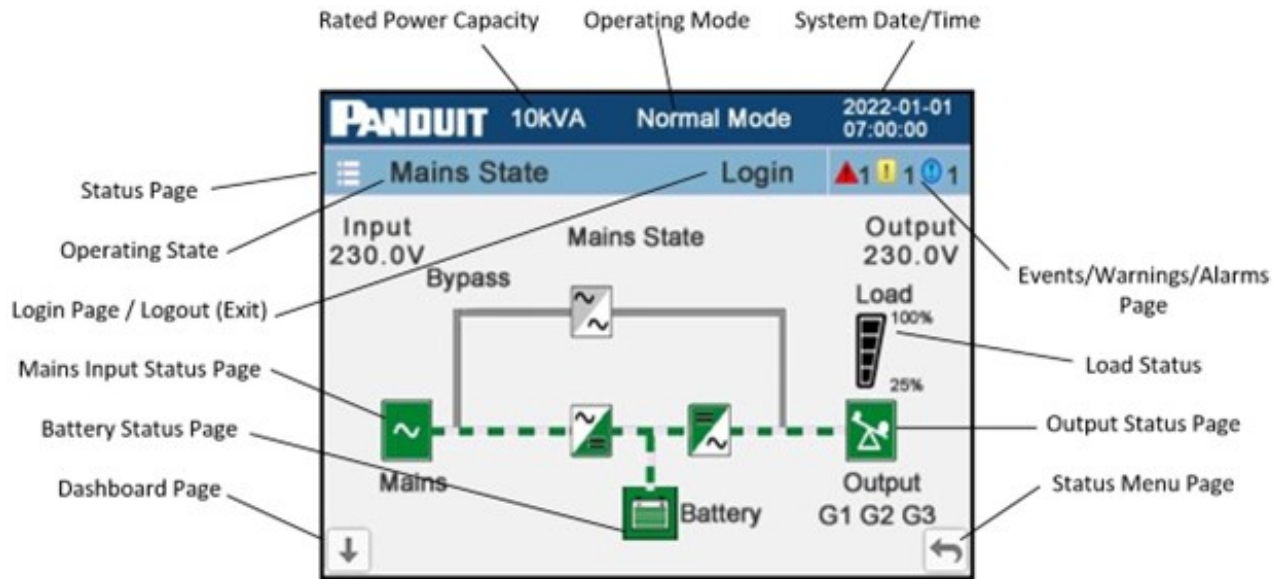

Figure 15a: 5-10kVA Home Page (EU Single-Phase UPS)

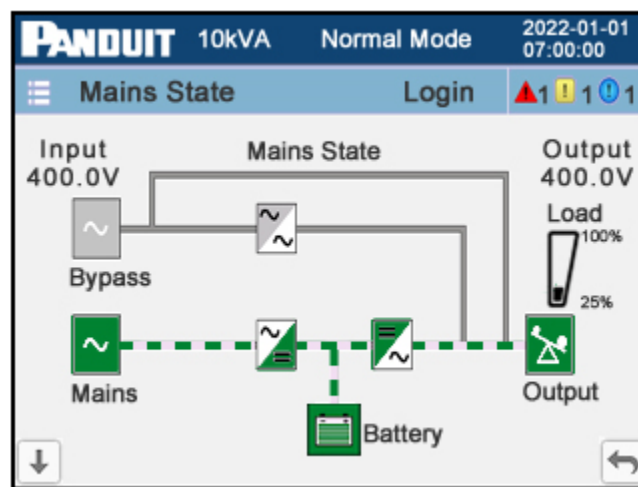

Figure 15b: 10-20kVA Home Page (3-Phase UPS)

The dark blue banner along the top of the page provides the kVA of the unit, the system

working mode, and the date and time that is set in the system.

The light blue banner near the top of the page provides the system status and allows the user to transition to other pages. Pressing the three horizontal bars takes the user to a Status Menu page. Refer to the [Status Menu Page](#) section below. For a functioning UPS unit, the Main State will be replaced with the current operating state of the UPS. Pressing on the Login location allows the user to login into the UPS with specific credentials that were previously entered into the system. The three icons and numbers to the left of the Login are the current Critical Alerts, Warning Alerts, and Events on the system. Pressing on this location transitions to the Current Alarm page. Refer to the [Alarm Pages](#) section below.

The remainder of the page provides a block diagram of the system, highlighting the current UPS working state. The dashed green line represents the path of the power flow. Active components are shown in green. Inactive components are shown as gray. The examples in [Figure 15](#) and [Figure 16](#) show the UPS in Normal mode working in the Normal state (on-line double conversion). Pressing on the Input/Mains, Bypass, Battery, or Output block is a shortcut to the detailed page for that function.

From the home page the down arrow transitions to the dashboard page (refer to [Figure 17](#)) and the up and over arrow transitions to the Status Menu page (refer to [Figure 18](#)).

Dashboard Page

This page provides all the power measurements consolidated on a single page. For single phase units only one measured value will be in each category.

Press the up arrow to go back to the previous page. Press the up and over arrow to go to the home page. Press the **HOME** icon to go to the Status Menu page.

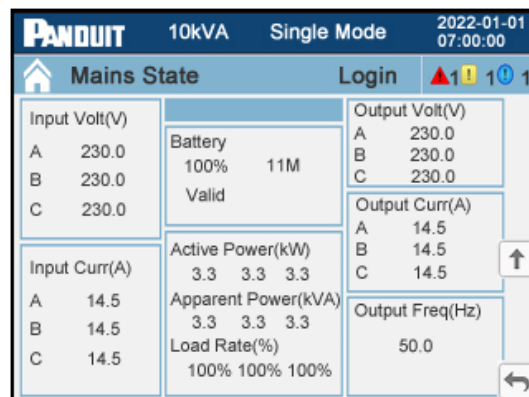

Figure 15c: Dashboard Page (3-Phase UPS)

Status Pages

Status Menu Page

This is a menu page for the status pages.



Figure 16a: Status Menu Page (3-Phase UPS)

The dark blue band along the bottom of the page provides quick links to menu pages.

1. Home page (magnifying glass) – main page, power flow diagram
2. Status Menu page (right/left arrows) – system status information
3. Alarm Menu page (bell) – current alarms, alarm history
4. Settings Menu page (gear wheel) – basic and advanced configurable settings
5. Maintenance Menu page (hand tools) – maintenance options
6. Common Menu page (hand touch point) – battery presence check
7. About page (question mark sheet) – system and firmware information

Note: A small green “+” sign is next to the icon of the page type that the screen is currently displaying.

Mains/Input Status Page

This page provides detailed input measurements.

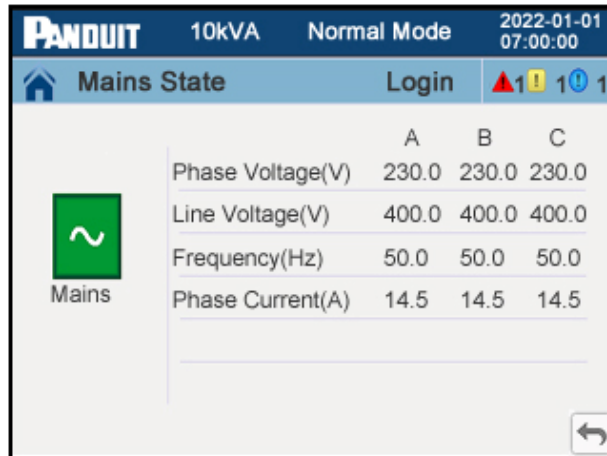

Figure 17a: Main Input Status Page (3-Phase UPS)

For the single-phase UPS units this is called the Input page. This page provides only one measurement for the input Voltage, the input Current and the input Frequency.

Press the up and over arrow to return to the previous page, the Status Menu page, or Home Page depending on operations used to get to this page (through the Status Menu page or through the Home page).

Bypass Input Status Page

This page provides detailed bypass input measurements, this page is supported only on the 3-phase UPS.

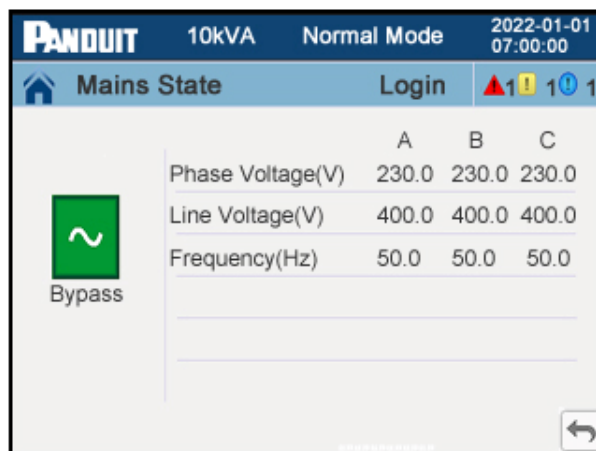

Figure 17b: Bypass Status Page (3-Phase UPS)

Press the up and over arrow to return to the previous page, the Status Menu page, or Home Page depending on operations used to get to this page.

Output Status Page

These two pages provide detailed output measurements.

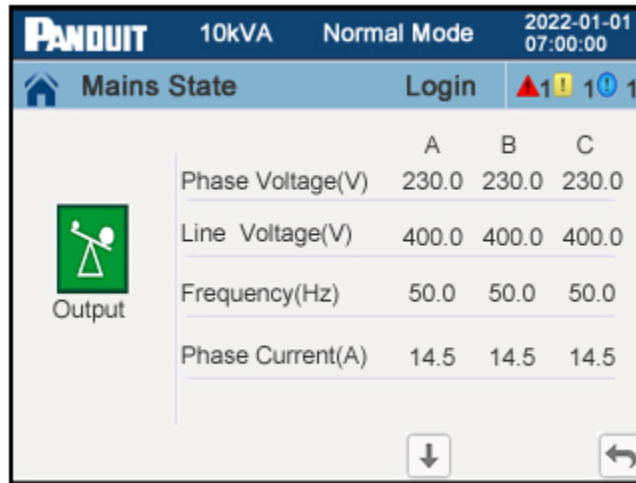

Figure 18a: Output Status Page 1 (3-Phase UPS)

For the single-phase UPS units, there is only one measurement for the output Voltage, the output Current, and the output Frequency.

Press the down arrow to go to the next output page. Press the up and over arrow to return to the previous page, the Status Menu page, or Home Page depending on operations used to get to this page.

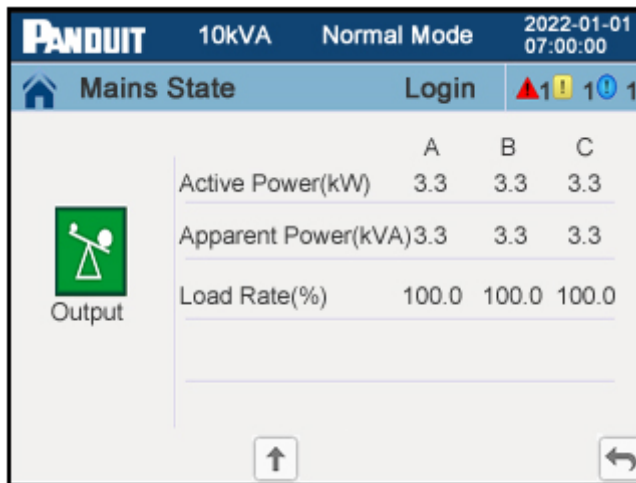

Figure 18b: Output Status Page 2 (3-Phase UPS)

For the single-phase UPS units, there is only one measurement for the output Active Power, the output Apparent Power, and the output Load Rate.

Press the up arrow to go to the previous output page. Press the up and over arrow to return to the previous page, the Status Menu page, or Home Page depending on operations used to get to this page.

Status Information Page

These one to three pages provide the status of various miscellaneous points internal in the UPS.

5-10kVA Single-phase UPS Units

The 5-10kVA single-phase UPS units have a single Status Info page.

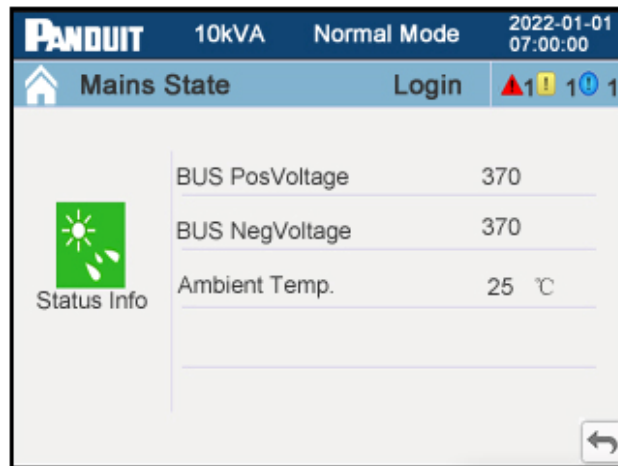

Figure 19: Status Information Page (Single-Phase VRLA UPS)

This page contains the measured positive and negative bus voltage internal in the UPS and the measured ambient temperature at the input of the UPS. The normal range of this DC bus is between 280V to 470V. If the bus voltage is outside of this range, an internal fault alarm will be triggered. This page also shows the ambient temperature. On the 5-10kVA Lithium UPS units there is an additional item for the MBS output breaker status.

Press the up and over arrow to return to the Status Menu page. You can only get to this page from the Status Menu page.

10-20kVA 3-Phase UPS Units

The 10-20kVA 3-phase UPS units have three Status Info pages.

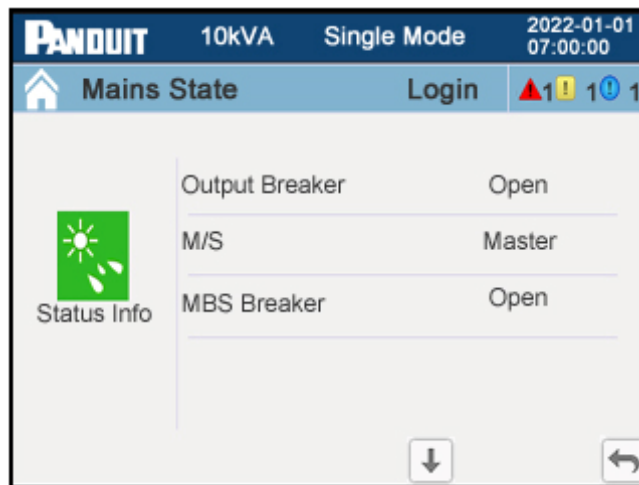

Figure 20a: Status Information Page 1 (3-Phase UPS)

This page contains the status of the Output Breaker in the MBS unit. This breaker is sensed through the OUTPUT sensor port on the back of the UPS. This page also contains the Master/Slave status automatically assigned to this UPS unit (when in the Parallel mode system configuration). This page also contains the status of the MBS Breaker. If the MBS breaker is open, it either indicates there is no MBS connected in the system or there is an MBS in the system and the MBS is configured so the UPS is providing power to the load. When the MBS breaker is closed it means there is an MBS in the system and the plate for the MBS breaker is removed to allow this breaker to transfer the power around the UPS and to the load. (When this breaker is closed and the Output breaker is open then the UPS is isolated from power and can be removed for maintenance). The status of this MBS breaker plate is sensed through the MAINT sensor port on the back of the UPS.

Press the down arrow to go to the next Information Status page. Press the up and over arrow to return to the Status Menu page.

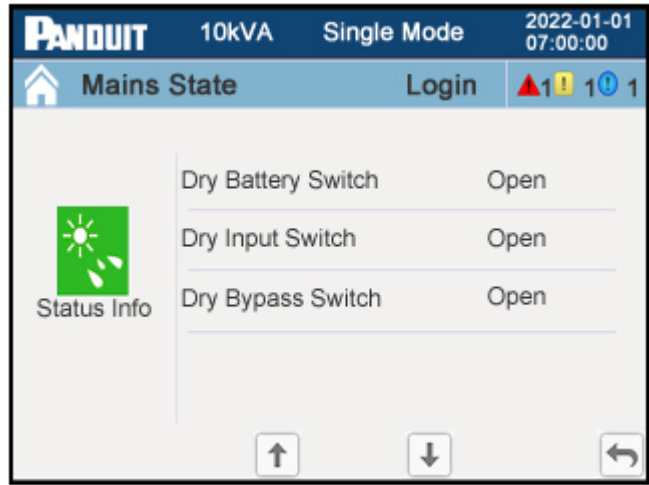

Figure 20b: Status Information Page 2 (3-Phase UPS)

The second page contains the status of the three dry contact points (battery switch, input switch, and bypass switch).

Press the down arrow to go to the next Status Information page. Press the up arrow to go to the previous Status Information page. Press the up and over arrow to return to the Status Menu page.

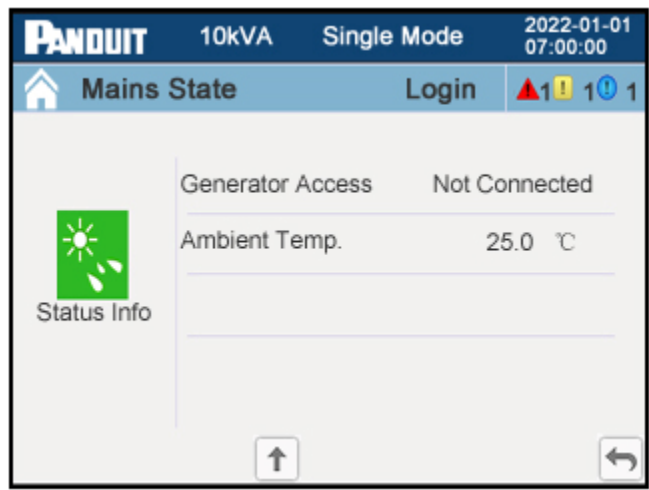

Figure 20c: Status Information Page 3 (3-Phase UPS)

The third page contains the Generator Access status. The Generator Access point is sensed through an IN dry contact port on the back of the UPS. When a generator is connected to the UPS, the generator feedback must be connected to an IN dry contact point on the back of the UPS. This contact point must be configured to Generator (see Advanced Settings). This page also contains the Ambient Temperature at the input side

of the UPS (where the air enters the UPS from the cold aisle). The Ambient Temperature is measured with a temperature sensor and is displayed on this page.

Press the up arrow to go to the previous Status Information page. Press the up and over arrow to return to the Status Menu page.

Battery Status Page

These two pages provide the status of the battery connected to the UPS.

Note: All references to battery in this section refer to all EBP units connected to the system as one battery.

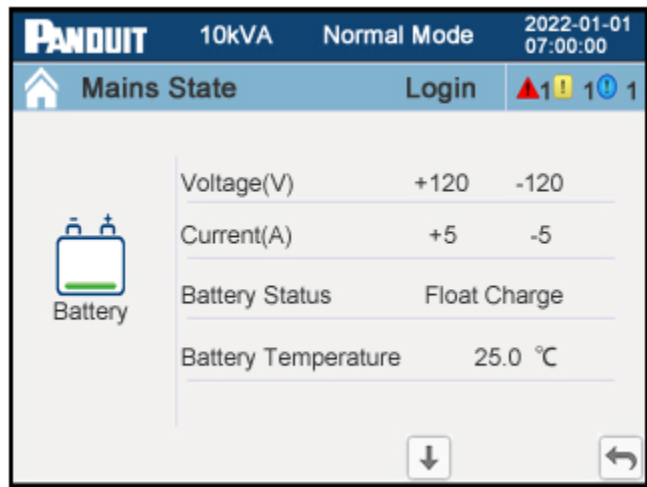

Figure 21a: Battery Status Page 1 (Single-Phase UPS)

The first page contains the battery voltage, battery current, battery status, and ambient temperature in the first connected EBP unit.

Note: The voltage and current are shown for the positive battery and the negative battery as described in **Section 1 – System Overview** of this document. The overall battery voltage and current is the sum of the two absolute numbers (the 5-10kVA single-phase UPS unit’s voltage is in the range of 240V and the 10-20kVA 3-phase UPS unit’s voltage is in the range of 480V).

Note: It is assumed that all EBP units connected to the UPS are in the same environment. The battery temperature on this page is the battery temperature in the first EBP connected to the UPS.

Press the down arrow to go to the next Battery Status page. Press the up and over arrow to return to the previous page, the Status Menu page, or Home Page depending on operations used to get to this page.

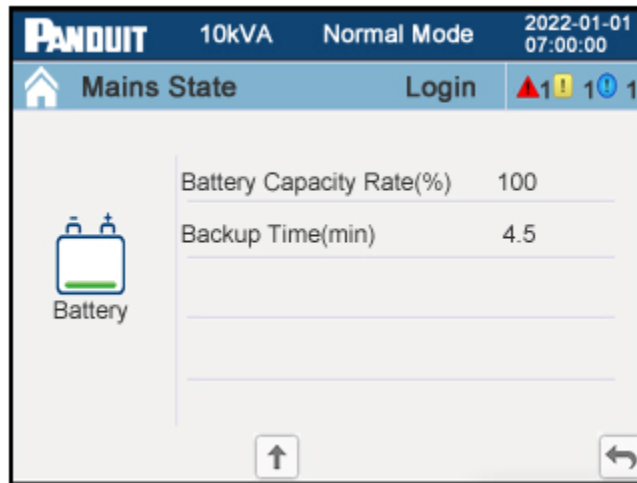

Figure 21b: Battery Status Page 2

The second page contains the status of the Battery capacity as a percentage of the maximum capacity and the battery backup time in minutes.

Press the up arrow to go to the previous Battery Status page. Press the up and over arrow to return to the previous page, the Status Menu page, or Home Page depending on operations used to get to this page

BMS Page (Battery Management System)

Supported on 1-Phase 5-10kVA Lithium UPS units, these pages provide the BMS monitoring information for connected Lithium external battery packs.

The UP and DOWN arrows will cycle through the BMS for each connected battery pack. The BMS monitors battery maximum and minimum cell voltage, temperature, and the current State of Health (SOH).

Note: SOH is considered a measure of battery condition. It is a ratio of maximum charge to rated capacity.

Alarm Pages

Alarm Menu Page

This is the Alarm Menu page for two alarm pages and the audio alarm control.

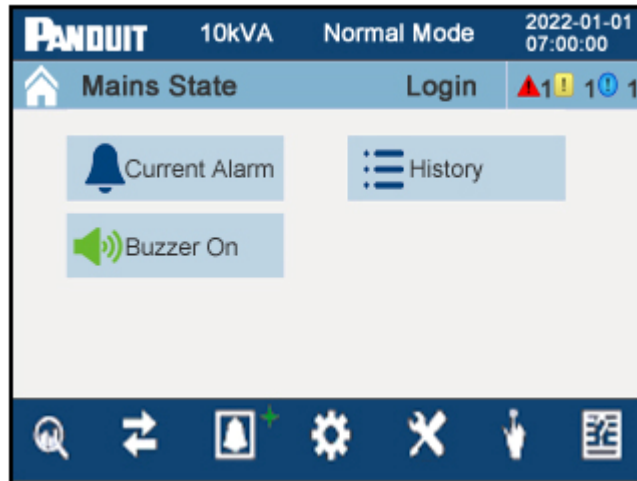

Figure 22a: Alarm Menu Page with Audio ON

From this page the user may access the Current Alarm page or the History logging page, or configure the audio alarms on the UPS.

Current Alarm Page

This page provides the list of the critical and warning alerts that are currently active in the system.

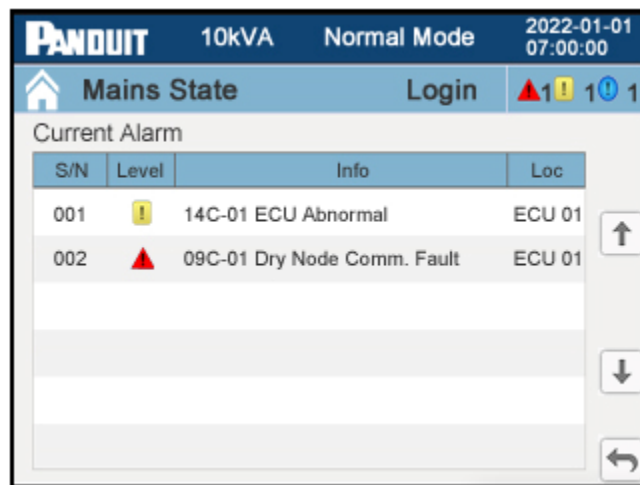

Figure 22b: Current Alarm Page

The most recent alert is at the top of the list. Alerts are identified by the red critical alarm

icons and by yellow warning alarm icons. Each entry also includes an alert code, a short description and the location where the error occurred. When the alert is cleared it will be recorded in the History log page.

Press the up arrow to scroll up in the list. Press the down arrow to scroll down in the list. Press the up and over arrow to return to the Alarm Menu page.

History Page

This page provides the History log of alerts/events that have happened in the UPS system.

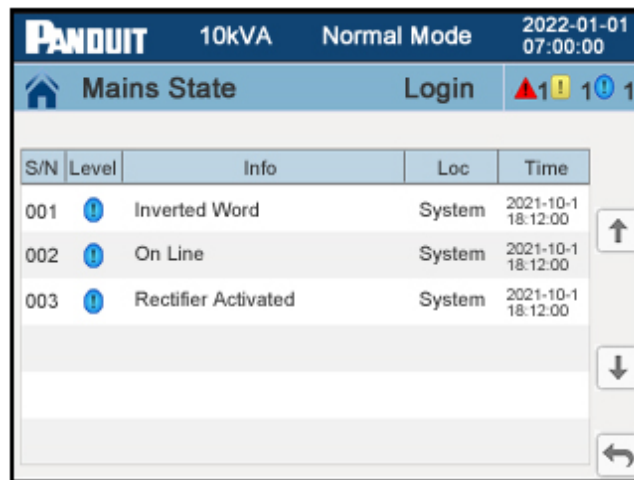

Figure 22c: History Page

The most recent alert/event is at the top of the log. Alerts are identified by the red critical alarm icon or by the yellow warning alarm icon and events are identified by the blue event icon. Each entry also includes a short description, the location where the alert/event occurred, and a date/time stamp when it occurred.

Press the up arrow to scroll up in the History log. Press the down arrow to scroll down in the History log. Press the up and over arrow to return to the Alarm Menu page.

Buzzer Setting

Pressing the Buzzer ON/OFF location on the Alarm Menu page mutes or unmutes the audio alarms in the UPS.

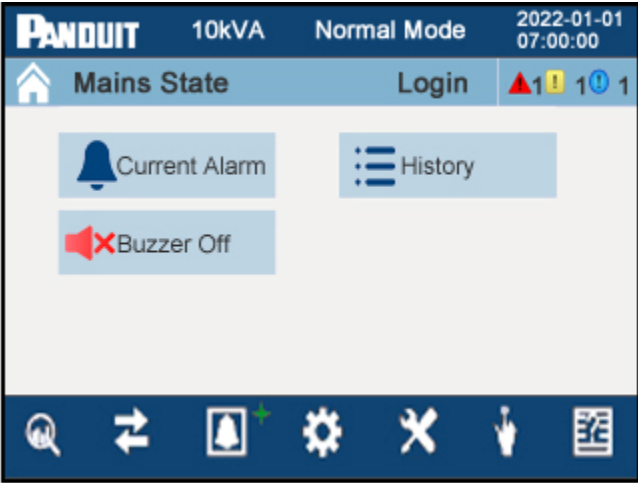

Figure 22d: Alarm Menu Page with Audio OFF

The audio alarm location toggles between mute and unmute every time it is pressed. When the audio is unmuted, this location will have a green speaker icon as shown in **Figure 22a**. When the audio is muted, this location will have a red speaker icon as shown in the figure above.

Setup Pages

Setup Menu Page

The Setup Menu is two layers deep. The first layer is the Setup Menu page for the Basic Setup Menu or the Advanced Setup Menu on the UPS.

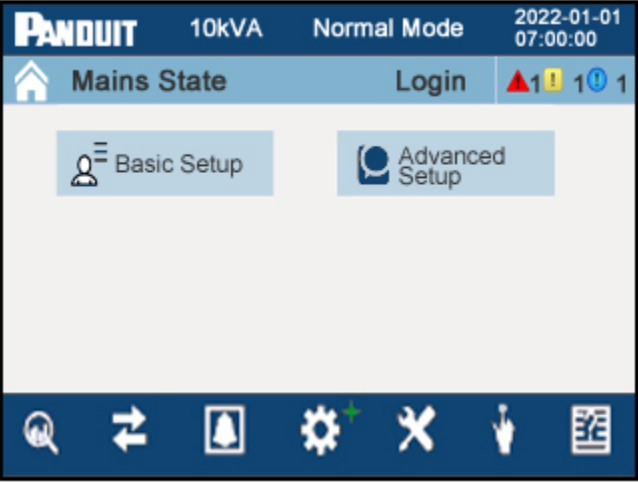

Figure 23a: Setup Menu Page

Pressing the Basic Setup transitions to the Basic Setup Menu page. Pressing the Advanced Setup transitions to a Password Entry page (if the user is not already logged

in with the proper credentials), where the appropriate password must be entered to continue to the Advanced Setup Menu page.

[Basic Setup Menu Page](#)

This Basic Setup Menu page has four Basic Setup pages.

From this page the user may transition to the basic setup page that needs to change. All basic setups are related to settings on the front panel display of the UPS.

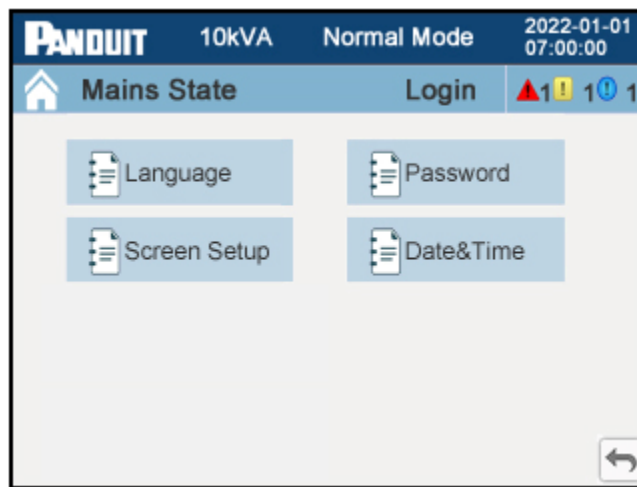

Figure 23b: Basic Setup Menu Page

Press the up and over arrow to return to the Setup Menu page.

[Language Setup Page](#)

This page allows the user to set the language to be shown on the display.

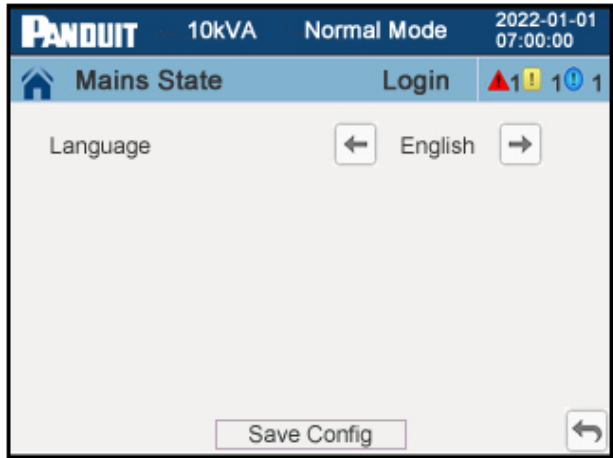

Figure 23c: Language Setup Page

Press the left and right arrows on the Language line to scroll through the available language options supported on the UPS. The default is English. After selecting the appropriate language, press the “Save Config” button to save this language.

Press the up and over arrow to return to the Basic Setup Menu page.

Password Setup Page

This page allows the user to change the password and password lock out time on the system.



Figure 23d: Password Setup Page

This page has three password entry boxes for entering the current password and then entering the new password twice. **The default password is “123456”**. Panduit recommends changing this password as soon as possible for security reasons.

Pressing a password entry box transitions the display to the Password Keyboard page.

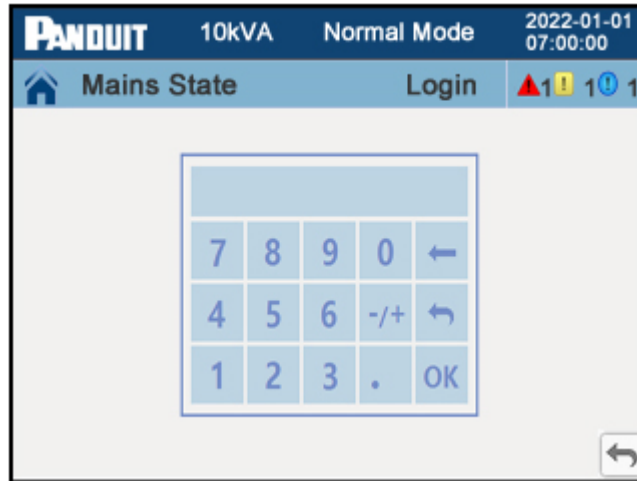

Figure 23e: Password Keyboard Page

On the Password Keyboard page (the left arrow is for backspace, the up and over arrow is for cancel and return to the Password Setup page, and OK is for enter) enter the appropriate old password and press the “OK” button. This will transition the display back to the Password Setup page. Complete the new password entries the same way.

Note: The password format is six numbers. The user must enter the appropriate information into all three password entry boxes and save the configuration for the new password to take effect.

Under the password entry boxes are left and right arrows on the “Password Lock Time” line. Scroll to the desired time in minutes. The user will be forced out of the login if there has been no activity on the display for the number of minutes specified in this line.

After making all the necessary changes on this page, press the “Save Config” button to save the password and password lockout changes.

Press the up and over arrow to return to the Basic Setup Menu page.

[Screen Setup Page](#)

This page allows the user to set the display’s brightness, timeout, and orientation.

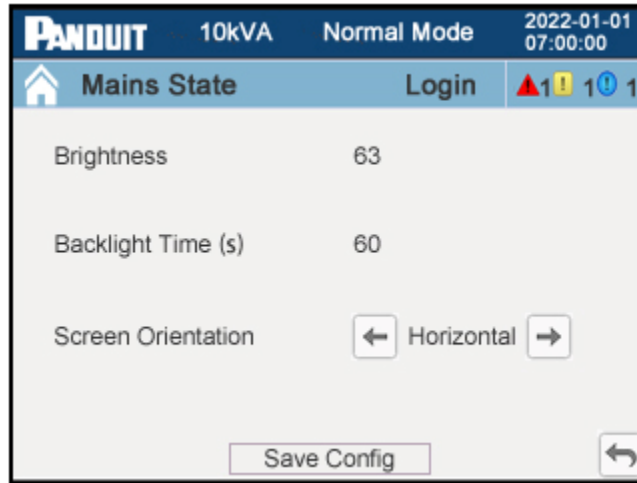

Figure 23f: Screen Setup Page

To change the brightness of the display press on the Brightness number and enter a new number from 10 to 63 (63 is the brightest). The default is 63.

On the Backlight Time line, press the number to enter a new number from 10 to 255 seconds. The default is 255 seconds. This is the number of seconds that the display will stay lit with no activity before turning OFF to conserve power.

To lock the screen orientation, press on the left or right arrow to select Horizontal or Vertical. The default is Horizontal.

After making all the necessary changes on this page, press the “Save Config” button to save the changes.

Press the up and over arrow to return to the Basic Setting Menu page.

[Date and Time Setup Page](#)

This page allows the user to set the date and time in the UPS.

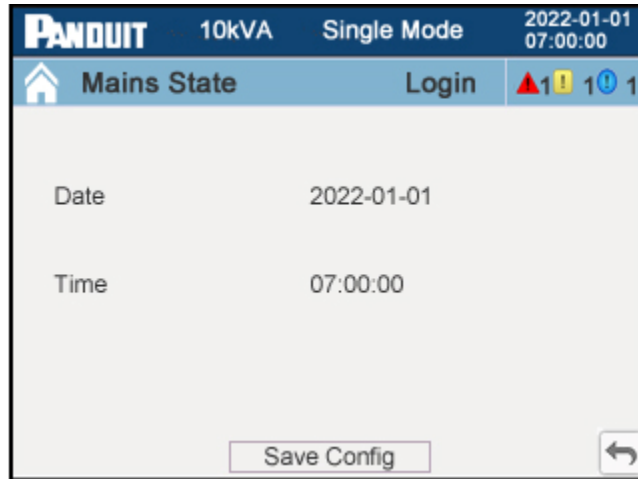

Figure 23g: Date and Time Setup Page

To change the date, press on the date field in the date line and enter the Year, Month, and Day in the following format: YYYY-MM-DD.

To change the time, press the time field in the Time line and enter the Hour (24 hour format), Minute, and Second in the following format: HH:MM:SS. This date and time is shown at the top of all pages and is used to timestamp the alert/event log and for running periodic tests.

Note: The system date and time in this menu are stored internally and may not be the same as the date and time set up through the NMC controller web interface.

After making all the necessary changes on this page, press the “Save Config” button to save the changes.

Press the up and over arrow to return to the Basic Setup Menu page.

On the Basic Setup Menu page, press the up and over arrow to return to the Setup Menu page.

[Advanced Setup Menu Page](#)

Note: These operations are recommended to be performed by professional service providers, or under the guidance of professional service providers. These pages are password protected.

Pressing on Advanced Setup transitions the display to the Password Entry page if the user was not already logged in with the proper credentials.

Password Entry Page

This is the Password Entry page that appears when attempting to access the Advanced Setup pages.

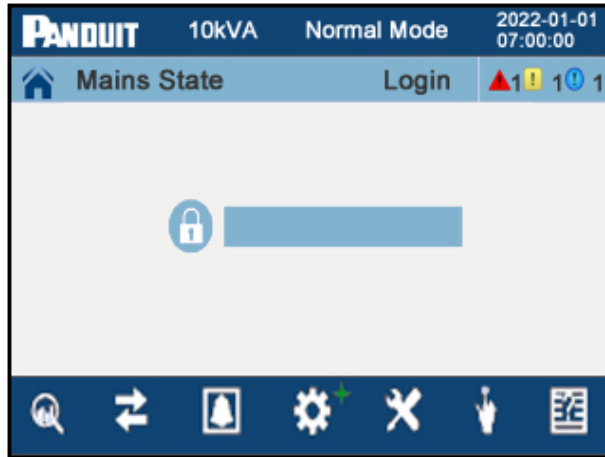

Figure 24a: Password Entry Page

Pressing on the password entry box transitions the display to the Password Keyboard page.

Password Keyboard Page

This is the Password Keyboard page that allow the user to enter the appropriate password.

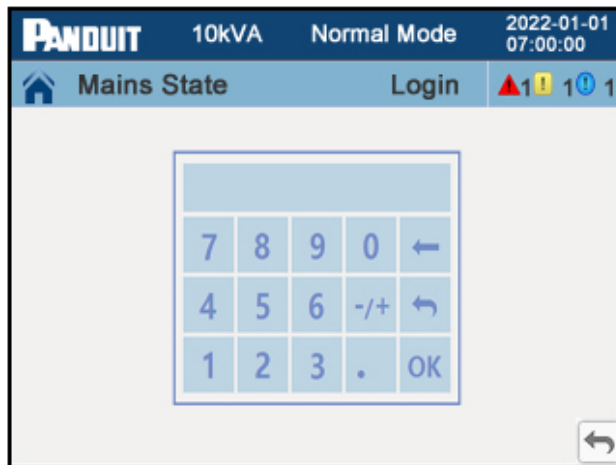

Figure 24b: Password Keyboard Page

Enter the appropriate password (the left arrow is for backspace, the up and over arrow is for cancel and the OK is for enter) and press the “OK” button; this will transition the

display to the Password Entry page. The password entry box will have six “Stars” and a “Login” button will appear under the box. Pressing on the “Login” button, logs the user into the UPS and transitions the display to the Advanced Setting Menu page.

Note: The default password is “123456”.

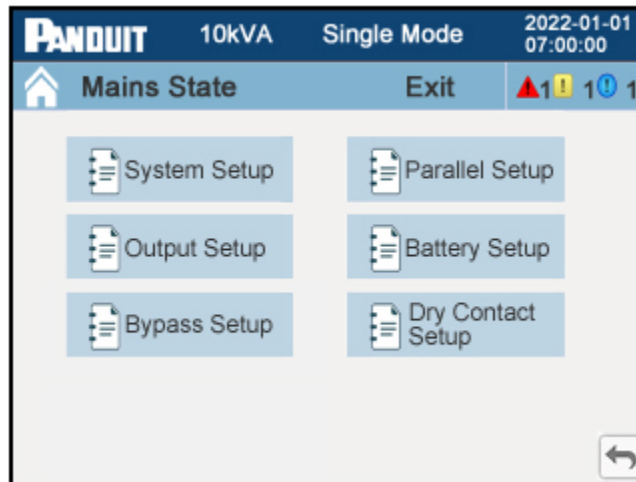

Figure 24c: Advanced Setting Menu Page (3-Phase UPS)

Once logged in, the Login location in the light blue banner along the top of the page transitions from “Login” to “Exit”. The user will stay logged in until the login has timed out or until the user presses on this Exit location.

From this page the user may transition to one of the four (for single-phase VRLA UPS units), five (for single-phase Lithium UPS), or six (for 3-phase UPS units) setup pages. All advanced setups are related to the architecture and operations of the UPS system. The Parallel Setup and Dry Contact Setup pages do not exist on the single-phase Advanced Setup Menu page.

[System Setup Page](#)

This page allows the user to set the UPS system parameters.

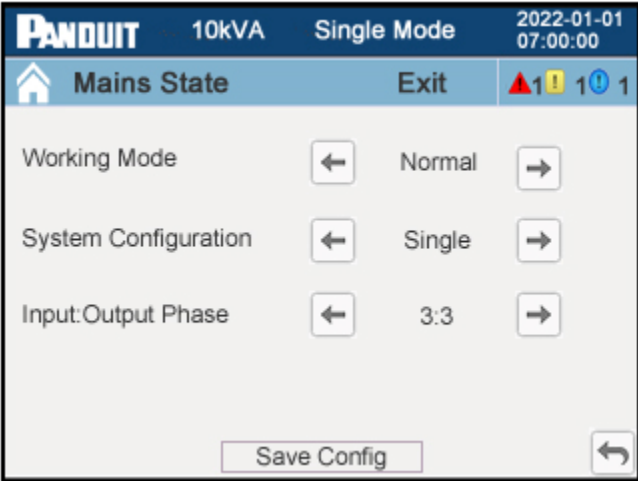

Figure 24d: System Setup Page (3-Phase UPS)

Press the left or right arrows on the Working Mode line to select Normal, Energy Saving (ECO), Convert Frequency (CF), or Generator (Gen) working mode, default is Normal. The 3-Phase UPS units do not have a Gen working mode option. Refer to the [UPS Working Modes](#) in Section 1 above for an explanation on all the working modes.

Press the left or right arrows on the System Configuration line to select Single or Parallel mode. The default is Single. This line is not present on the single-phase VRLA UPS units.

Press on the left or right arrows on the Input:Output Phase line to select 3:3 or 3:1. The default is 3:3. This line is not present on the single-phase VRLA UPS units.

After making all the necessary changes on this page, press the “Save Config” button to save the changes.

Press the up and over arrow to return to the Advanced Setup Menu page.

Parallel Setup Page

This page allows the user to set the UPS Parallel Mode System Configuration parameters. This page is not available on the single-phase VRLA UPS units.

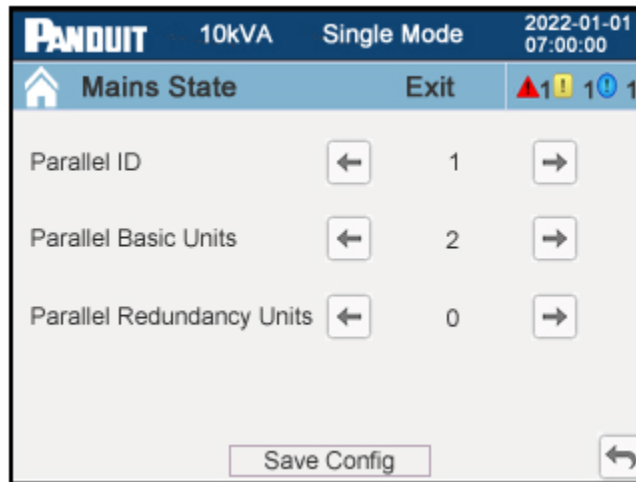

Figure 24e: Parallel Mode System Setup Page (3-Phase UPS)

Refer to the [Parallel Mode](#) subsection in Section 1 above for the proper steps to connect and configure a parallel mode system.

Press the left or right arrow on the Parallel ID line to select a number from 1 to 4 for the parallel ID number of that UPS. The default is 1.

Press the left or right arrow on the Parallel Basic Units line to select the number of units (2 to 4) in the Parallel System Configuration. The default number is 2.

Press the left or right arrow on the Parallel Redundancy Units line to select the number of units (0 to 3) in the Parallel System that are redundant units. The default number is 0 (meaning no redundancy).

Note: Redundant units are not calculated in the overall capacity of the parallel system.

After making all the necessary changes on this page, press the “Save Config” button to save the changes.

Press the up and over arrow to return to the Advanced Setting Menu page.

Output Setup Page

This page allows the user to set the UPS output parameters.

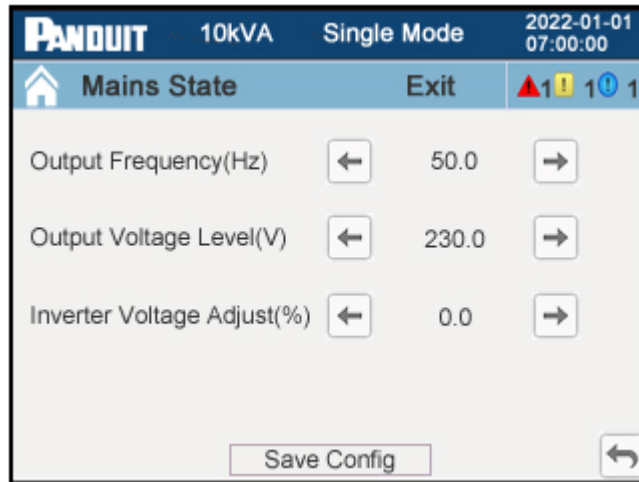

Figure 24f: Output Setup Page (3-Phase UPS)

Press the left or right arrow on the Output Frequency (Hz) line to select 50 or 60Hz as the desired output frequency of the UPS. The default depends on the UPS SKU. EU UPS units default to 50Hz, and NA UPS units are defaulted to 60Hz.

Press the left or right arrow on the Output Voltage Level(V) line to select the output voltage (220, 230, or 240 for EU UPS units and 208 or 240 for NA UPS units). The default depends on the UPS SKU. EU UPS units are defaulted to 230V, and NA UPS units are defaulted to 208V.

Press the left or right arrow on the Inverter Volt Adjust (%) line to select from -5% to +5% (in steps of 0.5%) adjustments to obtain the desired output voltage of the UPS. The default is set to 0. This adjustment is critical for a Parallel mode system configuration to ensure optimal load sharing across the UPS units in the system. This line is not present on the single-phase VRLA UPS units.

After making all the necessary changes on this page, press the “Save Config” button to save the changes.

Press the up and over arrow to return to the Advanced Setup Menu page.

Battery Setup Pages

These three pages allow the user to set the system battery parameters of the UPS.

5-10kVA Single-Phase UPS

There are 3 battery setup pages for the 5-10kVA single-phase UPS units.

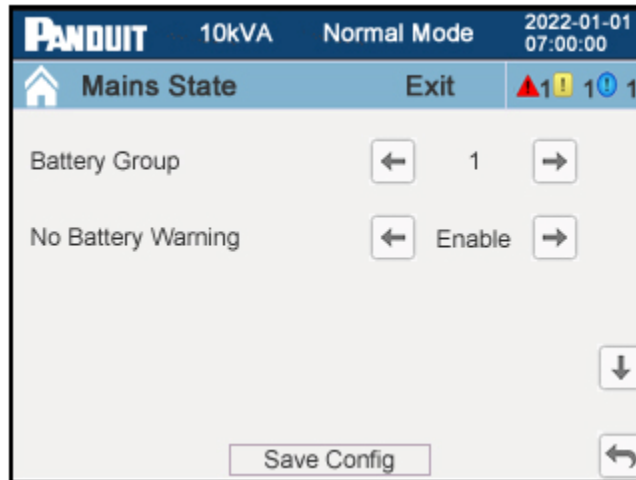

Figure 24g: Battery Setup Page 1 (Single-Phase UPS)

Press the left or right arrow on the Battery Group line to select 1 to 5 (VRLA) or 1 to 4 (Lithium) for the number of EBP units connected to the UPS. The default value is 1 EBP.

Press the left or right arrow on the No Battery Warning line to enable or disable the no battery warning.

After making all the necessary changes on this page, press the “Save Config” button to save the changes.

Press the down arrow to go to the next battery setup page. Press the up and over arrow to return to the Advanced Setup Menu page.

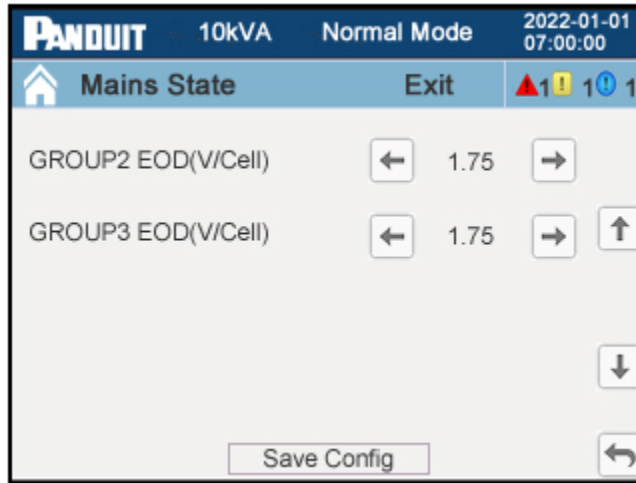

Figure 24h: Battery Setup Page 2 (Single-Phase EU VRLA UPS)

For VRLA UPS models, press the left or right arrows in the GROUP2 EOD (V/Cell) line to select the cell voltage (1.75V, 1.84V, or 1.92V) at which Outlet Group 2 will automatically turn OFF. The default is 1.75V, which is the same voltage that the Group 1 outlets will turn OFF when running in battery mode. A higher cell voltage will turn OFF the outlet group sooner and allow longer runtime on the critical loads that may be connected to Outlet Group 1.

For single-phase Lithium UPS models, this value will be represented as a SOC (State of Capacity) percentage (0%, 25%, 50%). When a battery is discharged to this capacity, the Group 2 outlet will be disabled. The default on these systems is 0%.

For EU VRLA region models only, Press the left or right arrows in the GROUP3 EOD (V/Cell) line to select the cell voltage (1.75V, 1.84V, or 1.92V) at which Outlet Group 3 will automatically turn OFF. The default is 1.75V, which is the same voltage that the Group 1 outlets will turn OFF when running in battery mode. A higher cell voltage will turn OFF the outlet group sooner and allow longer runtime on the critical loads that may be connected to Outlet Group 1.

For single-phase Lithium UPS models, this value will be represented as a SOC (State of Capacity) percentage (0%, 25%, 50%). When a battery is discharged to this capacity, the Group 3 outlet will be disabled. The default on these systems is 0%.

After making all the necessary changes on this page, press the “Save Config” button to save the changes.

Press the down arrow to go to the next battery setup page. Press the up arrow to go to the previous battery setup page. Press the up and over arrow to return to the Advanced Setup Menu page.

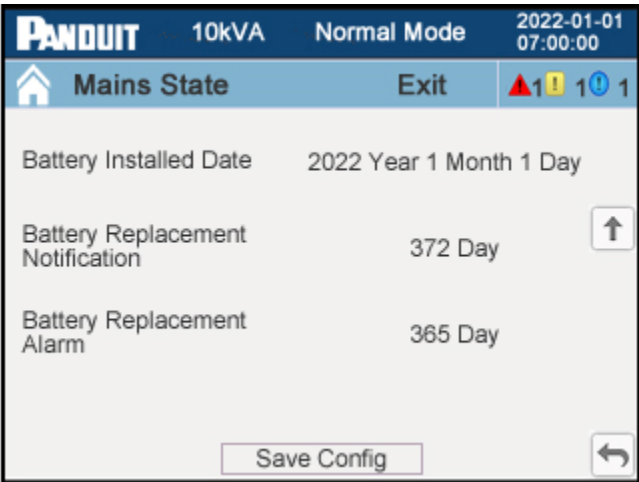

Figure 24i: Battery Setup Page 3 (Single-Phase UPS)

On the Battery Installed Date line, press the number in front of the Year to type in the install year. Press the number in front of the Month to type in the install month. Press the number in front of the Day to type in the install day. The default values for the year, month and day are based on when the battery was fully charged at build time. It may not reflect the date that the battery was last fully charged. The user should change this date to the UPS install date at completion of installation.

For UPS models using VRLA batteries, the system is programmed to alert 1095 days (3 years) after the set installed Date. For UPS models using Lithium batteries, the system is programmed to alert 2920 days (8 years) after the set installed Date. The user may adjust the replacement notification and alarm by reducing this maximum amount by the number of days specified in the next two fields.

On the Battery Replacement Notification line, press on the number in front of the Day to type in the number of days less than the maximum days from the install date when the UPS will notify the user (via a warning) that the battery cartridges are near end of life. The default is 372 days. This value has a range from 0 to 730 days. For VRLA models, if the default value is not changed, the warning will alert at $1095 - 372 = 723$ days (slightly less than 2 years) after the installation date. This warning is intended to allow the user to order replacement battery cartridges and replace the cartridges before the replacement alarm is triggered. The user should change this interval based on their company policies for replacing the respective battery type.

On the Battery Replacement Alarm line, press the number in front of the Day to type in the number of days less than the maximum days from the install date when the UPS will notify the user (via an alarm) that the battery cartridges should be replaced, the default is 365 days (7 days after the Battery Replacement Notification warning). This value has a range from 0 to 365 days. For VRLA models, if the default value is not changed, the alarm will alert at $1095 - 365 = 730$ days (or 2 years) after the installation date. This alarm is intended to notify the user that the battery cartridges should be replaced now. The user should change this interval based on their company policies for replacing the respective battery type.

After making all the necessary changes on each page, press the “Save Config” button before leaving the individual page to save the changes.

Press the up arrow to go to the previous page. Press the up and over arrow to return to the Advanced Setting Menu page.

10-20kVA 3-Phase VRLA UPS

There are 3 battery setup pages for the 10-20kVA 3-phase VRLA UPS units.

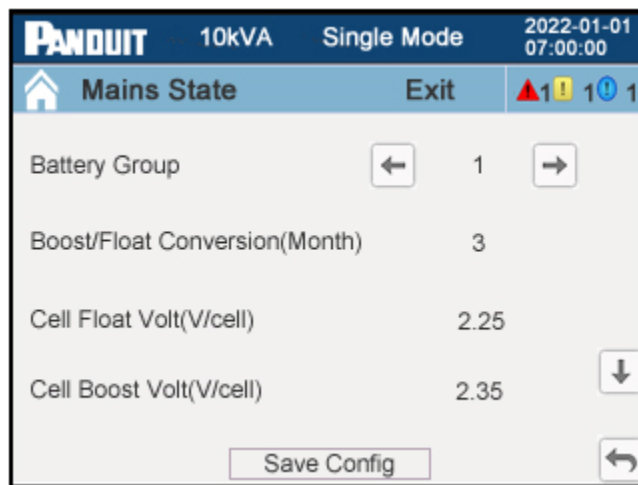

Figure 24j: Battery Setup Page 1 (3-Phase UPS)

Press the left or right arrow on the “Battery Group” line to select 1 to 8 for the number of EBP units connected to the UPS. The default value is 1 EBP.

The Boost/Float Conversion feature is a battery life optimization tool. Batteries age at different rates, causing an imbalance in the batteries. Panduit recommends boosting charge unbalanced batteries on a regular basis to extend the life of the battery.

By default, this feature is disabled (set to 0 months) on a new system with new batteries. Panduit recommends enabling this feature 6 months after the battery has been installed. Select the appropriate number for this value (1-24) based on the Cell Float Voltage setting. Increase the frequency of this setting (set this number to a lower month value) for a lower cell float voltage. (For a cell float voltage of 2.20, 2.21 or 2.22V, set this number to 3 months.) Decrease the frequency of this setting (set this number to a higher month value) for a higher cell float voltage. (For a cell float voltage of 2.28 or 2.29V, set this number to 6 months.) Use the following table for recommended Boost/Float Conversion settings.

Float charging voltage										
Recommended Setting (Month)	2.20	2.21	2.22	2.23	2.24	2.25	2.26	2.27	2.28	2.29
	3			4			5		6	

The Cell Float Voltage is a battery life optimization parameter. Press the left or right arrows in the “Cell Float Volt (V/Cell)” line to adjust the battery cell float voltage from 2.20 to 2.29 V/cell in increments of 0.01V. The default value is 2.25 V/cell. A higher cell float voltage will keep the batteries at a higher capacity but will have more impact on the battery life.

Press the left/right arrows in the “Cell Boost Volt (V/Cell)” line to adjust the battery cell boost voltage from 2.30 to 2.40 V/cell, the default value is 2.35 V/cell. A higher cell boost voltage allows the battery to charge faster but will have more impact on the battery life.

After making all the necessary changes on this page, press the “Save Config” button to save the changes.

Press the down arrow to go to the next battery setup page. Press the up and over arrow to return to the Advanced Setup Menu page.

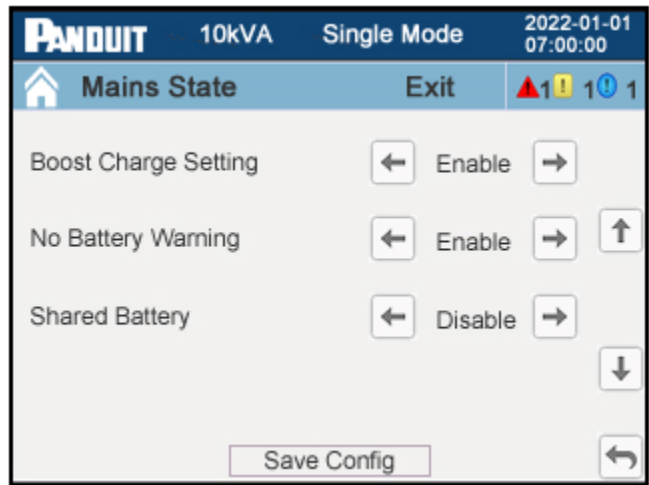

Figure 24k: Battery Setup Page 2 (3-Phase UPS)

Press the left/right arrows in the “Boost Charge Setting” line to enable or disable battery boost charging. The default is Enable. This is a battery life optimization parameter.

Press the left/right arrows in the “No Battery Warning” line to enable or disable the warning when a battery is not present. The default is Enable. When enabled, a warning will trigger on the system when a battery is not detected by the UPS unit.

Press the left/right arrows in the “Shared Battery” line to enable or disable battery charging through the parallel UPS units in the system. The default is Disable. Enabling this feature allows the batteries to be charged from all the UPS units in the parallel system.

Note: This feature is only supported in a parallel mode system.

After making all the necessary changes on this page, press the **Save Config** button to save the changes.

Press the down arrow to go to the next battery setup page. Press the up arrow to go to the previous battery setup page. Press the up and over arrow to return to the Advanced Setup Menu page.



Figure 24I: Battery Setup Page 3 (3-Phase UPS)

On the Installed Date line, press the number in front of the Year to type in the install year, press the number in front of the Month to type in the install month, and press the number in front of the Day to type in the install day. The default values for the year, month and day are based on when the battery was fully charged at build time. The user should change this date to the UPS install date at completion of installation.

The system is programmed to alarm 1095 days (3 years) after the set installed Date. The user may adjust the replacement notification and alarm by reducing the 1095 days by the number of days specified in the next two fields.

On the Battery Replacement Notification line, press the number in front of the Day to type in the number of days less than 1095 days from the install date when the UPS will notify the user (via a warning) that the battery cartridges are near end of life. The default is 372 days. This value has a range from 0 to 730 days. If the default value is not changed, the warning will alert at $1095 - 372 = 723$ days after the installation date. This warning is intended to allow the user to order replacement battery cartridges and replace the cartridges before the replacement alarm is triggered. The user should change this interval based on their company policies for replacing VLRA batteries.

On the Battery Replacement Alarm line, press the number in front of the Day to type in the number of days less than 1095 days from the install date that the UPS will notify the user (via an alarm) that the battery cartridges should be replaced. The default is 365 days (7 days after the Battery Replacement Notification warning). This value has a range from 0 to 365 days. If the default value is not changed, the alarm will alert at $1095 - 365 = 730$ days (or 2 years) after the installation date. This alarm is intended to notify the user that the battery cartridges should be replaced now. The user should change

this interval based on their company policies for replacing VLRA batteries.

After making all the necessary changes on each page, press the “Save Config” button before leaving the individual page to save the changes.

Press the up arrow to go to the previous page. Press the up and over arrow to return to the Advanced Setting Menu page.

Bypass Setup Page

This page allows the user to set the bypass limits and ranges on the UPS. If the UPS input is outside of these ranges, the UPS cannot switch to bypass.

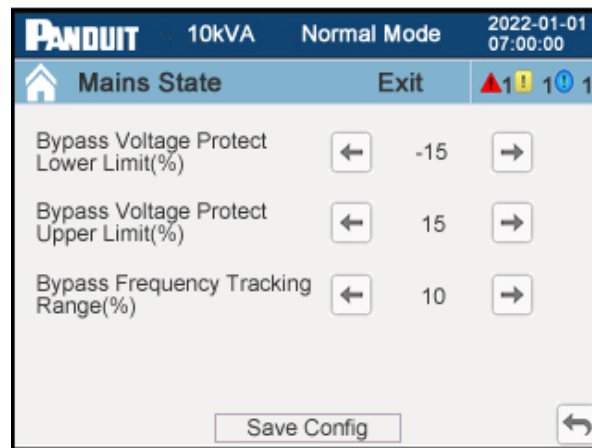

Figure 24m: Bypass Setup Page

Press the left or right arrow on the “Bypass Volt Protect Lower Limit” line to adjust the lower voltage limit on the UPS units. This limit is expressed as a negative percentage of the nominal input voltage. This value will determine how low the input voltage may be for the Bypass state to remain available. These ranges may vary by model. (Reference [Appendix E: Configuration Options.](#))

Press the left or right arrow on the “Bypass Volt Protect Upper Limit” line to adjust the upper voltage limit on the UPS units. This limit is expressed as a positive percentage of the nominal input voltage. This value will determine how high the input voltage may be for the Bypass state to remain available. These ranges may vary by model. (Reference [Appendix E: Configuration Options.](#))

Press the left or right arrow on the “Bypass Frequency Tracking Range” line to adjust the frequency range from $\pm 1\%$ to $\pm 10\%$ with a default of $\pm 10\%$. This value will determine what frequency range is required for the Bypass state to remain available.

After making all the necessary changes on this page, press the **Save Config** button to

save the changes.

Press the up and over arrow to go to the Advanced Setting Menu page.

Dry Contact Setting Pages

These two pages allow the user to set the meaning of the internal input and output dry contact ports on the 3-phase VRLA UPS units only. These pages are not available on the 5-10kVA Single-Phase UPS units.

The first page allows the user to define the input dry contact points.

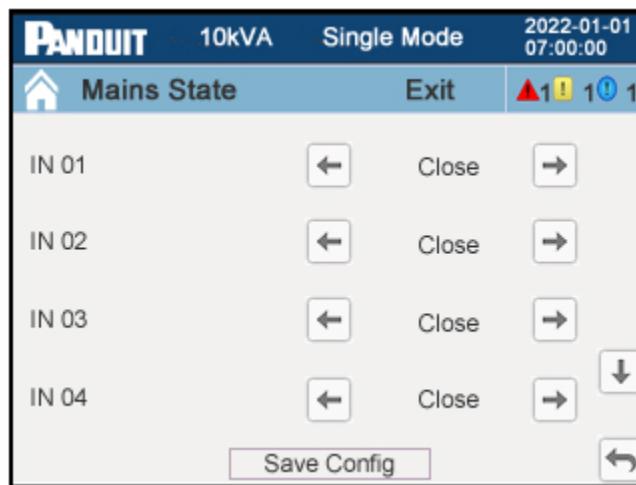

Figure 24n: Dry Contact Setup Page 1 (3-Phase UPS)

Press the left or right arrow on the “IN 01” line to select the meaning (close, INV ON, INV OFF, BATT Fault, Generator, User Alarm3, User Alarm4, Forbidden ECO, Force INV OFF, Input Switch, Bypass Switch, BATT Switch, BATT Trip, BATT Ground, Thunder, or EPO) of the first input dry contact (between IN pins 1 and 2 on the back of the UPS). The default is Close. Close means there is nothing assigned to this input dry contact. For example, if “INV ON” is assigned to this contact, then a remote closure of this contact will cause the inverter to turn ON.

Press the left or right arrow on the “IN 02” line to select the meaning of the second input dry contact (between IN pins 3 and 4 on the back of the UPS). The default is Close.

Press the left or right arrow on the “IN 03” line to select the meaning of the third input dry contact (between IN pins 5 and 6 on the back of the UPS). The default is Close.

Press the left or right arrow on the “IN 04” line to select the meaning of the fourth input dry contact (between IN pins 7 and 8 on the back of the UPS). The default is Close.

After making all the necessary changes on this page, press the “Save Config” button to save the changes.

Press the down arrow to go to the next page. Press the up and over arrow to return to the Advanced Setting Menu page.

The second page allows the user to define the output dry contact points.

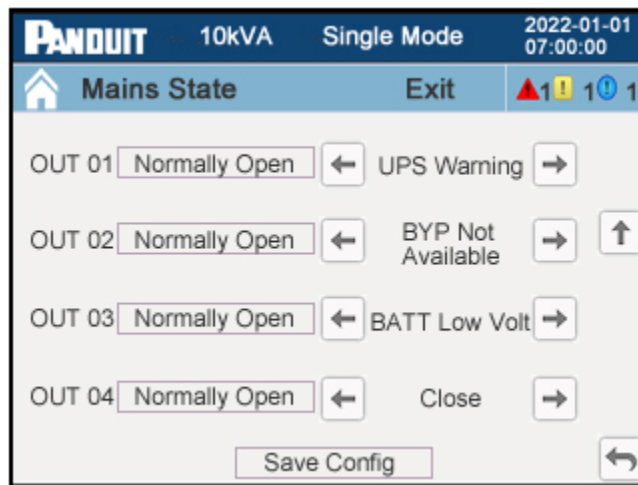

Figure 24o: Dry Contact Setup Page 2 (3-Phase UPS)

Pressing the button field next to the “OUT 01” contact toggles the sense of this output contact between “Normally Open” and “Normally Close”. Press the left or right arrow on the “OUT 01” line to select the meaning (close, UPS Warning, Normal Mode, Battery state, Bypass state, INV Overload, Fan Fault, Battery Fault, Battery Disconnected, Battery Low Voltage, Main Abnormal, Bypass Not Available, EPO, Maintenance Bypass Mode, Parallel Communications Fault, or ECO Mode) of the first output dry contact (between OUT pins 1 and 2 on the back of the UPS). The default is Close. Close means there is nothing assigned to this output dry contact.

Pressing on the button field next to the “OUT 2” contact toggles the sense of this output contact between “Normally Open” and “Normally Close”. Press the left or right arrow on the “OUT 02” line to select the meaning of the second output dry contact (between OUT pins 3 and 4 on the back of the UPS). The default is Close.

Pressing on the button field next to the “OUT 3” contact toggles the sense of this output contact between “Normally Open” and “Normally Close”. Press the left or right arrow on the “OUT 03” line to select the meaning of the third output dry contact (between OUT pins 5 and 6 on the back of the UPS). The default is Close.

Pressing on the button field next to the “OUT 4” contact toggles the sense of this output

contact between “Normally Open” and “Normally Close”. Press the left or right arrow on the “OUT 04” line to select the meaning of the fourth output dry contact (between OUT pins 7 and 8 on the back of the UPS). The default is Close.

After making all the necessary changes on this page, press the “Save Config” button to save the changes.

Press on the up arrow to go to the previous page. Press the down arrow to go to the next page. Press the up and over arrow to return to the Advanced Setting Menu page.

Maintenance Pages

[Maintenance Menu Page](#)

This Maintenance Menu page has two maintenance pages.

From this page the user may set up the automated battery tests or adjust the alignment of the touch screen on the front of the UPS unit.

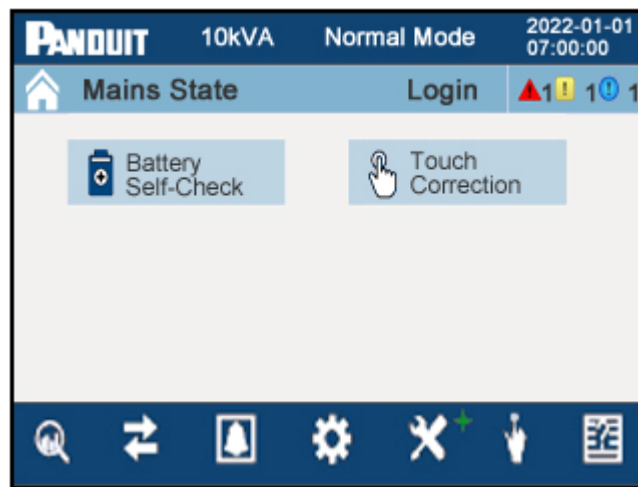

Figure 25a: Maintenance Menu Page

Pressing the Battery Self-Check transitions the display to the battery self-check setup page.

Press the touch correction button to align the touch screen to the touch point on the screen.

[Battery Self-Check Setup Page](#)

This is the setup for the Automatic Self-Check. The top spot in the list contains the current setting of the Automatic Self-Check.

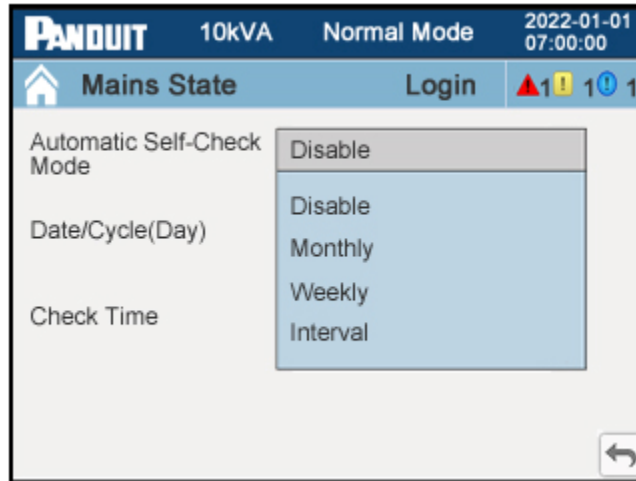

Figure 25b: Battery Self-Check Setup Page 1

Press one of the desired self-check modes in the list (which will automatically transition the screen to that setup page) to disable the default Automatic Self-Check state. Disable means that no self-checking is scheduled to be performed by the UPS.

Note: If a network card is installed in the UPS, leave the disabled default setting. Automated testing should be set up through the WebUI in the Network card to automatically run the test at the desired intervals.

- Pressing **Disable** transitions the screen to the “Disable” Setup page.
- Pressing **Monthly** transitions the screen to the “Monthly” Setup page.
- Pressing **Weekly** transitions the screen to the “Weekly” Setup page.
- Pressing **Interval** transitions the screen to the “Interval” Setup page.
- Press the up and over arrow to return to the Maintenance Menu page.

[Auto Self-Check Disable Setup Page](#)

This is the setup page to disable the automatic self-check for the UPS. There are no options on this page. It is used only to disable the Automatic Self-Check.

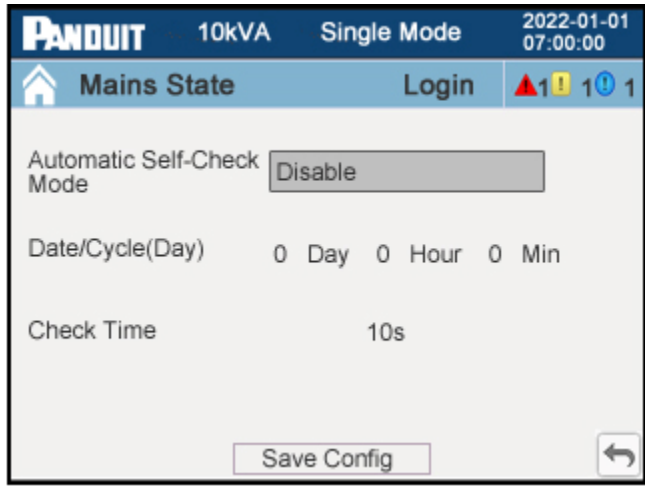

Figure 25c: Auto Self-Check Disable Setup Page

Press the **Save Config** button to disable the Automatic Self-Check through the UPS.

Press the up and over arrow to return to the Battery Self-Check Setup page.

Note: Upon returning to this page, the “Automatic Self-Check Mode” line will have “Disable” in the field on the top of the list. The self-check battery test is now disabled.

Note: This self-check should be disabled when the self-checking is performed through the WebUI on the network card or undesired double checking will be performed automatically.

[Auto Self-Check Monthly Setup Page](#)

This is the setup page for the monthly automatic self-check of the UPS.

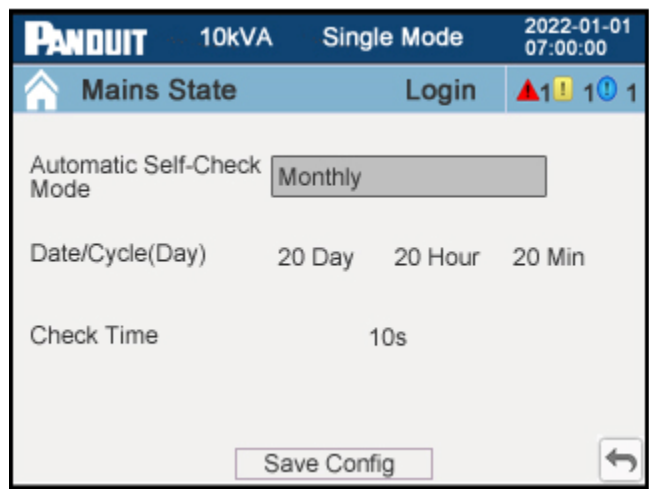

Figure 25d: Auto Self-Check Monthly Setup Page

Press the number in front of the “Day” in the “Date/Cycle (Day)” line to select the day in

the month when the self-check battery test should be run.

Press the number in front of the “Hour” to select the hour in that day when the self-check battery test should be run.

Note: This field is based on a 24-hour clock.

Press the number in front of the “Min” to select the minute in that hour when the self-check battery test should start.

The test time is defaulted to 10 seconds and cannot be changed.

Note: If Battery Self-Check is enabled in the WebUI through the network card, automatic self-checking in the UPS should be disabled, or undesired double checking will be performed automatically.

After making all the necessary changes on this page, press the **Save Config** button to save the changes.

Press the up and over arrow to return to the Battery Self-Check Setup page.

Note: Upon returning to this page, the “Automatic Self-Check Mode” line will have “Monthly” in the field on the top of the list. The self-check battery test is now scheduled to automatically run once a month on the day specified, at the hour specified, and start at the minute specified.

[Auto Self-Check Weekly Setup Page](#)

This page is the setup page for the weekly automatic self-check of the UPS.

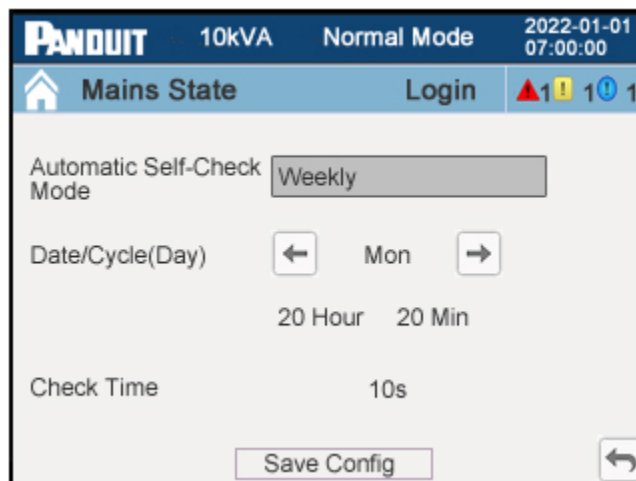

Figure 25e: Auto Self-Check Weekly Setup Page

Press the left/right arrows on the “Date/Cycle (Day)” to select the day in a week

(Sunday – Saturday) that the self-check test should be run.

Press the number in front of the “Hour” to select the hour in that day when the self-check test should be run.

Note: This field is based on a 24-hour clock.

Press the number in front of the “Min” to select the minute in that hour when the self-check test should start.

The test time is defaulted to 10 seconds and cannot be changed.

Note: If Battery Self-Check is enabled in the WebUI through the network card, automatic self-checking in the UPS should be disabled, or undesired double checking will be performed automatically.

After making all the necessary changes on this page, press the “Save Config” button to save the changes.

Press the up and over arrow to return to the Battery Self-Check Setup page.

Note: Upon returning to this page, the “Automatic Self-Check Mode” line will have “Weekly” in the field at the top of the list. The self-check battery test is now scheduled to automatically run once a week on the day specified, at the hour specified, and start at the minute specified.

[Auto Self-Check Interval Setup Page](#)

This page is the setup page for the interval automatic self-check of the UPS.

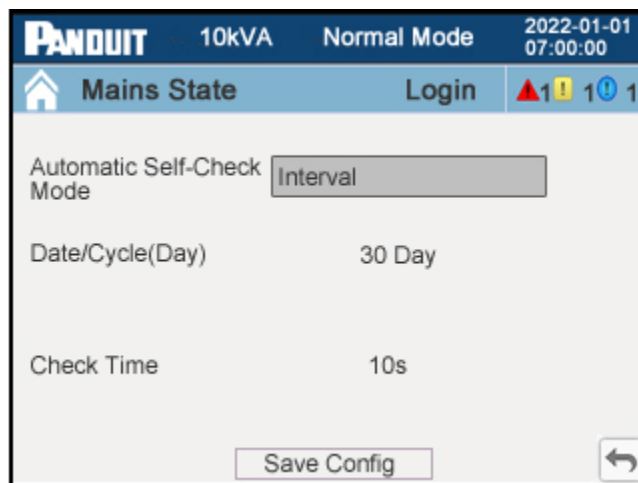

Figure 25f: Auto Self-Check Interval Setup Page

Press the number before the “Day” in the “Date/Cycle (Day)” line to select the number of

days between each automatic self-check test. The default is 30 days.

The test time is defaulted to 10 seconds and cannot be changed.

Note: If Battery Self-Check is enabled in the WebUI through the network card, automatic self-checking in the UPS should be disabled, or undesired double checking will be performed automatically.

After making all the necessary changes on this page, press the “Save Config” button to save the changes.

Press the up and over arrow to return to the Battery Self-Check Setup page.

Note: Upon returning to this page, the “Automatic Self-Check Mode” line will have “Interval” in the field at the top of the list. The self-check battery test is now scheduled to automatically run once every number of days as specified on this page.

[Touch Correction Page](#)

The touch correction page shows an x-y cross hair on the screen. The user must touch the intersection of the cross hair for the first screen calibration. Other x-y cross hairs will appear in other locations on the screen one by one. The user must touch the intersection of the cross hairs each time to complete the screen calibration. Upon completion of the calibration the screen automatically transitions back to the Maintenance Menu Page.

Common Pages

[Common Menu Page](#)

This Common menu page has three common pages which are different between the single-phase UPS and the 3-phase UPS units.

[Single-Phase Common Menu Page](#)

This is the common menu page for the 5-10kVA single-phase UPS units.

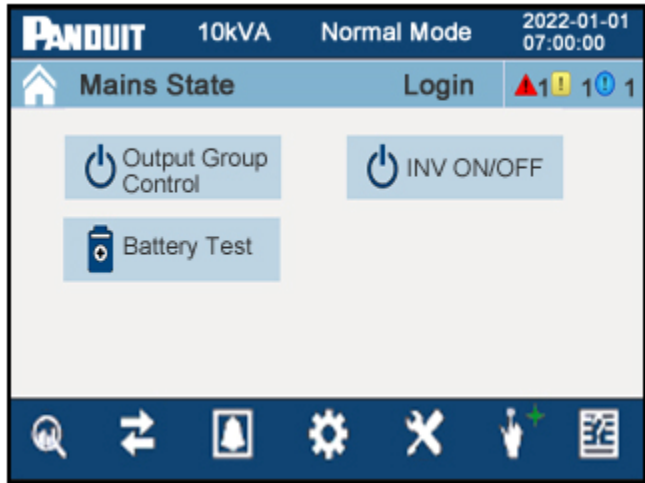

Figure 26a: Common Menu Page (Single-Phase UPS)

From this page, the user may access the outlet group control page, the inverter control page, or the manual battery test page on the single-phase UPS unit.

[3-Phase Common Menu Page](#)

This is the common menu page for the 10-20kVA 3-phase UPS units.

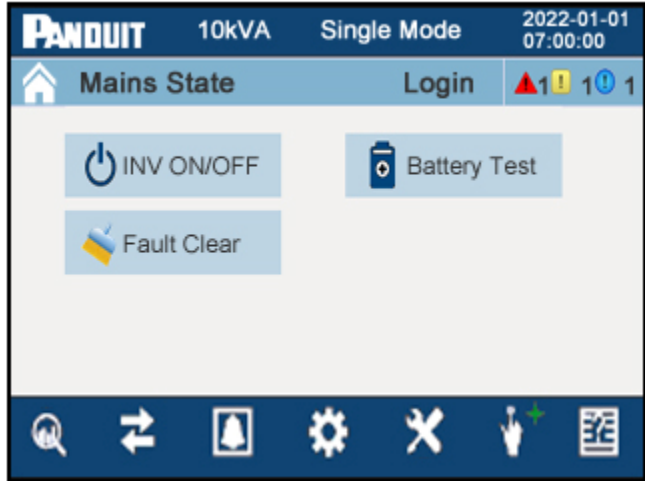

Figure 26b: Common Menu Page (3-Phase UPS)

From this page, the user may access the inverter control page, the manual battery test page, or the fault clear page on the 3-phase UPS unit. The 3-phase UPS units are all hardwire output connections, so there is no output group control.

[Outlet Group Control Page \(5—10kVA Single-Phase UPS Only\)](#)

This is the control page for the controllable outlet groups on the UPS. The 5-10KVA single-phase UPS units have 2 or 3 outlet groups. Outlet Group 1 is not controllable. This outlet group will stay on until the battery is depleted (while the UPS is running on

battery backup). Outlet groups 2 and 3 are controllable on the single-phase UPS units. The outlet groups are identified on the back of the UPS unit.

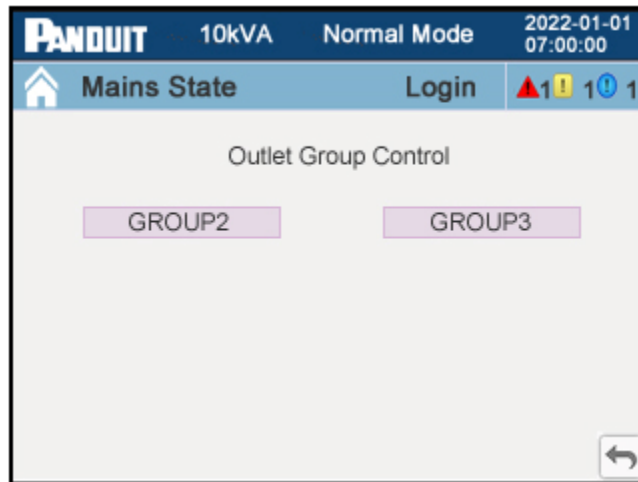

Figure 26c: Outlet Group Control Page (5-10kVA EU UPS unit)

This page allows the user to turn ON and OFF each controllable outlet group. The EU Single-Phase UPS units have two controllable outlet groups (Outlet Group 2 and outlet Group 3). The NA Single-Phase UPS units have one controllable outlet group (Outlet Group 2). This page will only have Group 2 for the NA units. Press either button on this page to toggle the outlet group from the previous state (OFF to ON or ON to OFF).

Press the up and over arrow to return to the Common Menu page.

The controllable outlet groups may also be controlled via the WebUI in the network card. These outlet groups may also be programmed to automatically turn OFF at a specific battery level, while running on battery backup, to extend runtime for the critical loads on outlet group 1 (refer to Battery Setup Page).

Press the up and over arrow to return to the Common Menu page.

[Inverter Control Page](#)

This is the control page for the UPS inverter circuit. This page allows the user to manually turn ON or OFF the output inverter.

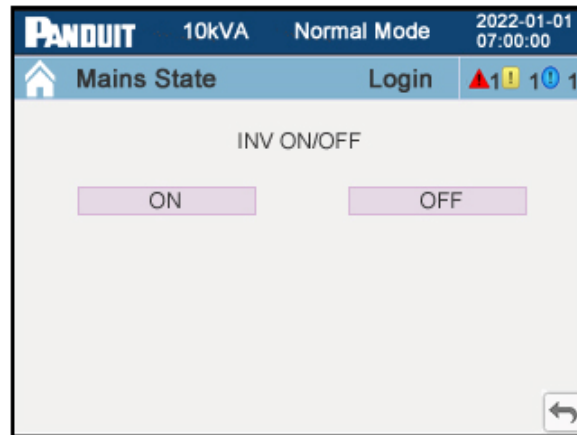

Figure 26d: Inverter Control Page

Pressing on the “ON” button turns the inverter circuit in the UPS unit(s) ON. Pressing the “OFF” button turns the inverter circuit in the UPS unit(s) OFF.

When the inverter is turned OFF, the UPS unit(s) will then transition to the Bypass state, assuming the Bypass state has not been previously disabled or the input is not out of the bypass range (setup earlier in the Advanced Setup section). If the Bypass state has been previously disabled or the input is out of bypass range, then the UPS unit output(s) will shut down. When the OFF or ON location is pressed the action will take effect immediately.

Press the up and over arrow to return to the Common Menu page.

[Battery Manual Test Page](#)

This page allows the user to manually test the UPS battery.

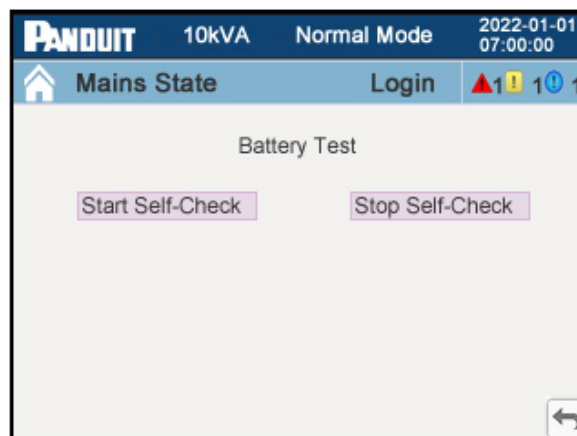

Figure 26e: Battery Manual Test Page

Pressing the “Start Self-Check” button will immediately start the battery test. Pressing

the “Stop Self-Check” button will immediately stop the battery test.

Note: The UPS will run on battery while the battery test is in process. The total battery test duration is 10 seconds.

Press the up and over arrow to return to the Common Menu page.

[Fault Clear Page \(10-20kVA 3-phase UPS only\)](#)

Press the Fault Clear button on the Common Menu page to manually clear certain UPS faults. There are intermittent faults and self-recoverable faults that may be manually cleared. Intermittent faults may occur based on erroneous readings. These faults may randomly appear during certain external operating conditions. If the fault is intermittent, it will get cleared through these steps. If the fault is persistent, the fault will reappear after clearing. Some self-recoverable faults may frequently occur (10 times within one hour) such as fan fault, rectifier overtemperature, rectifier overcurrent or frequent switching to bypass. If the UPS switches to bypass 10 times within an hour it will lock the UPS into the Bypass state. This fault must be cleared to enable the UPS to switch back to the Normal state.

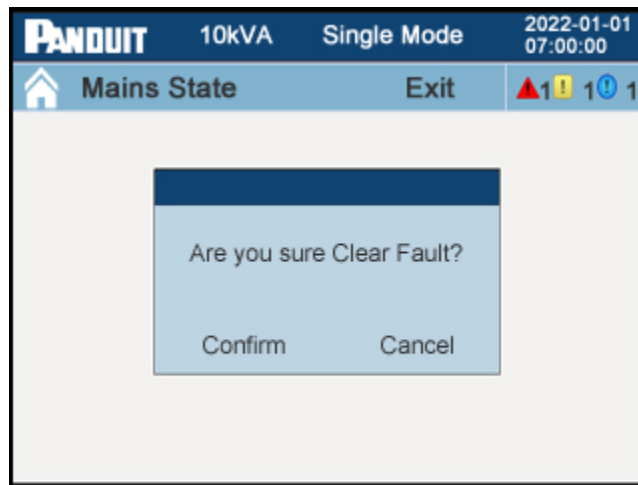

Figure 26f: Fault Clear Page

Pressing on **Confirm** clears the faults on the system and then transitions the screen back to the Common Menu page. Pressing **Cancel** returns the screen to the Common Menu page without clearing the faults on the system.

About Pages

The About pages provide high-level information about the UPS and the firmware loaded in the core modules of the UPS.

About Menu Page

This page provides the UPS SKU (Part) Number, the UPS Serial Number, the Manufacture Date, a user set IP Address (NMC required), and a link to the UPS Firmware Version pages.

For the single-phase Lithium UPS models, there is an additional link for the battery pack BMS Version.

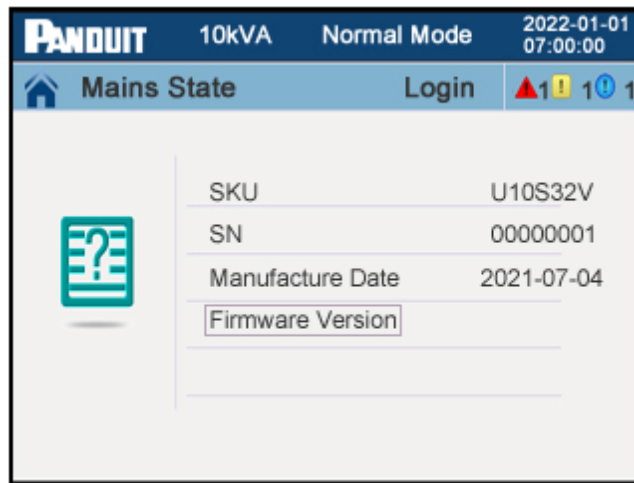

Figure 27a: About Menu Page (3-Phase 10kVA UPS)

Press the “Firmware Version” button at the bottom of the page to transition to the UPS Firmware Version page.

UPS Firmware Version Page

This page provides the firmware versions of each firmware module in the UPS.

5-10kVA Single-phase UPS Units

The 5-10kVA single-phase UPS units have three firmware modules.

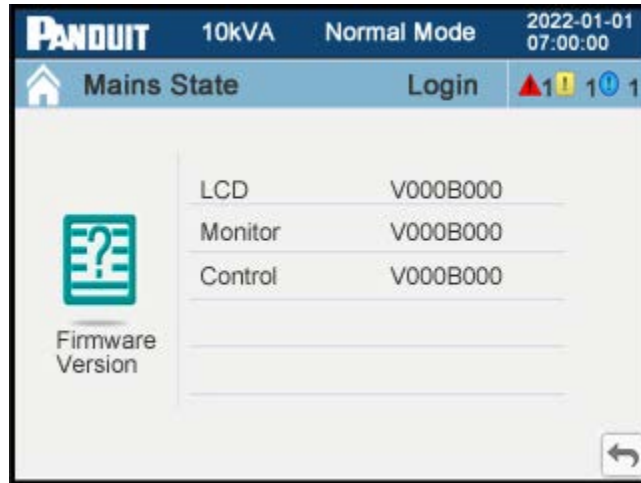

Figure 27b: Firmware Version Page (5-10kVA Single-phase)

The single-phase UPS units have LCD, Monitor, and Control firmware modules. Each firmware module could be at a different version number.

Press the up and over arrow to go to the About Menu page.

[10-20kVA 3-phase UPS Units](#)

The 10-20kVA 3-phase UPS units have four firmware modules.

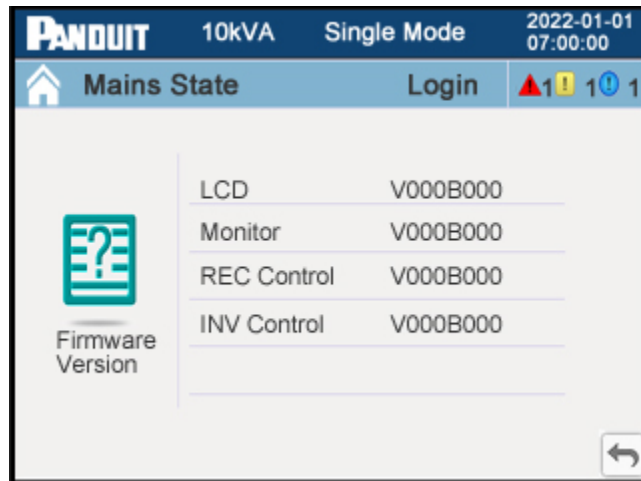

Figure 27c: UPS Firmware Version Page (3-Phase UPS)

The 3-phase UPS units have LCD, Monitoring, Rectifier Control, and Inverter Control firmware modules. Each firmware module could be at a different version number.

Press on the up and over arrow to go to the About Menu page.

BMS Version Page (Single-Phase Lithium UPS only)

This page provides the Lithium EBP BMS serial number and the EBP serial number.

Appendix A1: 5 to 10kVA Fault Codes & Alert LEDs

The following Fault Code Table lists the available Warning and Critical Fault codes shown on the display of the 5 to 10kVA Single-Phase UPS platform. The Buzzer will make a continuous beep or periodic beeps (about once per second). The Alert LED will either illuminate Yellow for Warning Alarms or Red for Critical Alarms. These may be subject to change based on the core FW version loaded in the UPS.

If the Fault Code cannot be cleared, then contact Panduit Customer Technical Support at techsupport@panduit.com or techsupportemea@panduit.com with the following information.

- Product SKU and serial number.
- Detailed explanation of the fault, such as LCD display info, LED lights status, etc.

Fault Code	Fault Description	Fault Type	Buzzer	LED	Action to Take
2	Input Over Voltage	Warning	Periodic	Yellow Alert On	Ensure that the source input voltage is within the UPS operating range
3	Input Under Voltage	Warning	Periodic	Yellow Alert On	Ensure that the source input voltage is within the UPS operating range
4	Input Frequency Abnormal	Warning	Periodic	Yellow Alert On	Ensure that the source input frequency is within the UPS operating range
5	+DC Bus Over Voltage	Critical	Continuous	Red Alert On	Reboot the UPS unit
6	-DC Bus Over Voltage	Critical	Continuous	Red Alert On	Reboot the UPS unit
7	DC Bus Over Voltage	Critical	Continuous	Red Alert On	Reboot the UPS unit
8	+DC Bus Under Voltage (output on)	Critical	Continuous	Red Alert On	Reboot the UPS unit
9	-DC Bus Under Voltage (output on)	Critical	Continuous	Red Alert On	Reboot the UPS unit

Fault Code	Fault Description	Fault Type	Buzzer	LED	Action to Take
10	+DC Bus Under Voltage (output off)	Critical	Continuous	Red Alert On	Reboot the UPS unit
11	-DC Bus Under Voltage (output off)	Critical	Continuous	Red Alert On	Reboot the UPS unit
12	DC Bus Delta (line)	Critical	Continuous	Red Alert On	Reboot the UPS unit
13	DC Bus Delta (battery)	Critical	Continuous	Red Alert On	Reboot the UPS unit
14	+DC Bus Soft Start Fault (Line)	Critical	Continuous	Red Alert On	Reboot the UPS unit
15	-DC Bus Soft Start Fault (Line)	Critical	Continuous	Red Alert On	Reboot the UPS unit
16	+DC Bus Soft Start Fault (battery)	Critical	Continuous	Red Alert On	Reboot the UPS unit
17	-DC Bus Soft Start Fault (battery)	Critical	Continuous	Red Alert On	Reboot the UPS unit
18	+DC Bus Discharge Fault	Critical	Continuous	Red Alert On	Reboot the UPS unit
19	-DC Bus Discharge Fault	Critical	Continuous	Red Alert On	Reboot the UPS unit
21	Inverter Output Under Voltage	Critical	Continuous	Red Alert On	Reboot the UPS unit
22	Inverter Output Over Voltage	Critical	Continuous	Red Alert On	Reboot the UPS unit
23	Inverter Fault	Critical	Continuous	Red Alert On	Reboot the UPS unit
24	Output Relay Won't Open	Critical	Continuous	Red Alert On	Reboot the UPS unit
25	Output Relay Won't Close	Critical	Continuous	Red Alert On	Reboot the UPS unit
26	Inverter Overload	Warning	Periodic	Yellow Alert On	Reduce the load on the UPS output
27	Inverter Overload Time Out	Warning	Periodic	Yellow Alert On	Reduce the load on the UPS output

Fault Code	Fault Description	Fault Type	Buzzer	LED	Action to Take
28	Inverter Input Over Voltage	Critical	Continuous	Red Alert On	Reboot the UPS unit
29	Output Measurement Mismatch	Critical	Continuous	Red Alert On	Reboot the UPS unit
30	Inverter Soft Start Error	Critical	Continuous	Red Alert On	Reboot the UPS unit
32	Output Short Circuit	Warning	Periodic	Yellow Alert On	Remove the loads and add back one at a time to detect load fault
33	Output Error	Critical	Continuous	Red Alert On	Reboot the UPS unit
34	Output High Over Voltage	Critical	Continuous	Red Alert On	Reboot the UPS unit
35	Output Under Voltage	Critical	Continuous	Red Alert On	Reboot the UPS unit
36	Output Over VA	Warning	Periodic	Yellow Alert On	Reduce the load on the UPS output
38	Battery Reversal Detected	Warning	Periodic	Yellow Alert On	Ensure that the EBP connector is properly and securely connected then Reboot the UPS unit
39	+Battery Over Voltage	Warning	Periodic	Yellow Alert On	Ensure that the EBP matches the UPS then Reboot the UPS unit
40	-Battery Over Voltage	Warning	Periodic	Yellow Alert On	Ensure that the EBP matches the UPS then Reboot the UPS unit
41	+Battery Disconnected	Warning	Periodic	Yellow Alert On	Ensure that the EBP connector is properly and securely connected
42	-Battery Disconnected	Warning	Periodic	Yellow Alert On	Ensure that the EBP connector is properly and securely connected
43	+Battery Low	Warning	Periodic	Yellow Alert On	Battery is nearly depleted, allow time for battery to recharge
44	-Battery Low	Warning	Periodic	Yellow Alert On	Battery is nearly depleted, allow time for battery to recharge
45	+Battery Depleted	Warning	Periodic	Yellow Alert On	Battery is depleted, allow time for battery to recharge
46	-Battery Depleted	Warning	Periodic	Yellow Alert On	Battery is depleted, allow time for battery to recharge

Fault Code	Fault Description	Fault Type	Buzzer	LED	Action to Take
47	EBP Error	Warning	Periodic	Yellow Alert On	Reboot the UPS unit
48	+Battery Charger Error	Critical	Continuous	Red Alert On	Reboot the UPS unit
49	-Battery Charger Error	Critical	Continuous	Red Alert On	Reboot the UPS unit
50	+Battery Charger Over Voltage	Critical	Continuous	Red Alert On	Reboot the UPS unit
51	-Battery Charger Over Voltage	Critical	Continuous	Red Alert On	Reboot the UPS unit
52	+Battery Charger Under Voltage	Critical	Continuous	Red Alert On	Reboot the UPS unit
53	-Battery Charger Under Voltage	Critical	Continuous	Red Alert On	Reboot the UPS unit
54	Battery Charger Measurement Mismatch	Critical	Continuous	Red Alert On	Reboot the UPS unit
57	Bypass Over Current	Warning	Periodic	Yellow Alert On	Reduce the load on the UPS
58	Bypass Voltage Abnormal	Warning	Periodic	Yellow Alert On	Ensure that the source input voltage is within the UPS operating range
59	Bypass Frequency Abnormal	Warning	Periodic	Yellow Alert On	Ensure that the source input frequency is within the UPS operating range
60	Bypass Overload	Warning	Periodic	Yellow Alert On	Reduce the load on the UPS
61	Bypass Overload Time Out	Warning	Periodic	Yellow Alert On	Reduce the load on the UPS
62	Maintenance Bypass Switch Activated	Warning	Periodic	Yellow Alert On	Ensure that the MAINT port on the back of the UPS is shorted together

Fault Code	Fault Description	Fault Type	Buzzer	LED	Action to Take
64	Battery High Temperature Exceeded	Critical	Continuous	Red Alert On	Ensure that the BAT_T cable is properly connected between the UPS and EBP Ensure that the ambient operating temperature is at or below 40°C
65	Battery Low Temperature Alarm	Critical	Continuous	Red Alert On	Ensure that the BAT_T cable is properly connected between the UPS and EBP Ensure that the ambient operating temperature is at or above 0°C
66	Battery High Temperature Alarm	Critical	Continuous	Red Alert On	Ensure that the BAT_T cable is properly connected between the UPS and EBP Ensure that the ambient operating temperature is at or below 40°C
67	Battery Temperature Sensor Disconnected	Warning	Periodic	Yellow Alert On	Ensure that the BAT_T cable is properly connected between the UPS and the first EBP
68	Fan Fault	Critical	Continuous	Red Alert On	Remove ventilation obstructions and reboot the UPS unit
69	UPS Over Temperature	Critical	Continuous	Red Alert On	Ensure that Ambient operating temperature is at or below 40C. Reduce the load Check if the battery group is set correctly Remove ventilation obstructions Reboot the UPS unit

Fault Code	Fault Description	Fault Type	Buzzer	LED	Action to Take
70	Heatsink Over Temperature Alarm	Critical	Continuous	Red Alert On	Ensure that Ambient operating temperature is at or below 40C Reduce the load Check if the battery group is set correctly Remove ventilation obstructions. Reboot the UPS unit
71	Ambient High Temperature Alarm	Warning	Periodic	Yellow Alert On	Ensure that the ambient operating temperature is at or below 40°C
72	Ambient Low Temperature Alarm	Warning	Periodic	Yellow Alert On	Ensure that the ambient operating temperature is at or above 0°C
74	Bypass Relay Won't Open	Critical	Continuous	Red Alert On	Reboot the UPS unit
75	Bypass Relay Won't Close	Critical	Continuous	Red Alert On	Reboot the UPS unit
76	Back feed Relay Won't Open	Critical	Continuous	Red Alert On	Reboot the UPS unit
77	Back feed Relay Won't Close	Critical	Continuous	Red Alert On	Reboot the UPS unit
78	Power Supply Error	Critical	Continuous	Red Alert On	Reboot the UPS unit
79	EEPROM Error	Critical	Continuous	Red Alert On	Reboot the UPS unit
80	RAM Error	Critical	Continuous	Red Alert On	Reboot the UPS unit
82	Internal Communications Error	Critical	Continuous	Red Alert On	Reboot the UPS unit
83	CPLD Error	Critical	Continuous	Red Alert On	Reboot the UPS unit
84	MCU Reset	Critical	Continuous	Red Alert On	Reboot the UPS unit
85	Back feed Relay Won't Operate	Critical	Continuous	Red Alert On	Reboot the UPS unit

Fault Code	Fault Description	Fault Type	Buzzer	LED	Action to Take
91	Parallel Overload Alarm	Warning	Periodic	Yellow Alert On	Reboot the UPS unit
93	Button Error	Warning	Periodic	Yellow Alert On	Reboot the UPS unit
95	EPO Activated	Warning	Periodic	Yellow Alert On	Ensure that the EPO port on the back of the UPS is shorted together Ensure the remote EPO dry contact is not activated Then reboot the UPS
96	Firmware Mismatch	Critical	Continuous	Red Alert On	Reboot the UPS unit

Appendix A2: 10 to 20kVA Fault Codes & Alert LEDs

The following Fault Code Table lists the available Warning and Critical Fault codes shown on the display of the 10 to 20kVA 3-Phase UPS platform. The Buzzer will make a continuous beep or periodic beeps (about once per second). The Alert LED will either illuminate Yellow for Warning Alarms or Red for Critical Alarms. These may be subject to change based on the core FW version loaded in the UPS.

If the Fault Code cannot be cleared, then contact Panduit Customer Technical Support at techsupport@panduit.com or techsupportemea@panduit.com with the following information.

- Product SKU and serial number.
- Detailed explanation of the fault, such as LCD display info, LED lights status, etc.

Fault Code	Fault Description	Fault Type	Buzzer	LED	Action to Take
002	Rectifier Over Temperature	Critical	Continuous	Red Alert On	Ensure that Ambient operating temperature is at or below 40C. Reduce the load Check if the battery group is set correctly Remove ventilation obstructions. Reboot UPS
003	Rectifier Parallel Signal Error	Critical	Continuous	Red Alert On	Reboot the UPS unit
004	Rectifier Overcurrent	Warning	Periodic	Yellow Alert On	Ensure that the source input voltage is within the UPS operating range Reduce the load Reboot the UPS unit
005	Rectifier Power Supply Error	Critical	Continuous	Red Alert On	Reboot the UPS unit
007	Input SCR Error	Critical	Continuous	Red Alert On	Reboot the UPS unit

Fault Code	Fault Description	Fault Type	Buzzer	LED	Action to Take
00A	Output Discharge SCR Error	Critical	Continuous	Red Alert On	Reboot the UPS unit
00C	Battery Charge SCR Error	Critical	Continuous	Red Alert On	Reboot the UPS unit
00E	Fan Fault	Critical	Continuous	Red Alert On	Remove ventilation obstructions and Reboot the UPS unit
011	Fan Power Supply Error	Critical	Continuous	Red Alert On	Remove ventilation obstructions and Reboot the UPS unit
012	UPS Over Temperature	Critical	Continuous	Red Alert On	Ensure that Ambient operating temperature is at or below 40C Reduce the load Check if the battery group is set correctly Remove ventilation obstructions. Reboot the UPS unit
013	DC Bus Soft Start Error	Critical	Continuous	Red Alert On	Reboot the UPS unit
014	Battery Charger Error	Critical	Continuous	Red Alert On	Reboot the UPS unit
016	Rectifier Communications Error	Critical	Continuous	Red Alert On	Reboot the UPS unit
019	Rectifier Initialization Fault	Critical	Continuous	Red Alert On	Reboot the UPS unit
01D	Power Block not Connected	Critical	Continuous	Red Alert On	Reboot the UPS unit
01E	Rectifier Error	Critical	Continuous	Red Alert On	Reboot the UPS unit
024	Battery Charger Overcurrent	Critical	Continuous	Red Alert On	Ensure the battery group is set correctly Remove ventilation obstructions Reboot the UPS unit
041	Inverter Error	Critical	Continuous	Red Alert On	Ensure that the proper copper bus bars are installer for the desired configuration Reboot the UPS unit

Fault Code	Fault Description	Fault Type	Buzzer	LED	Action to Take
044	Inverter IGBT Error	Critical	Continuous	Red Alert On	Ensure that the proper copper bus bars are installer for the desired configuration Reboot the UPS unit
047	Inverter Relay Won't Open	Critical	Continuous	Red Alert On	Ensure that the proper copper bus bars are installer for the desired configuration Reboot the UPS unit
04A	Inverter Relay Won't Close	Critical	Continuous	Red Alert On	Ensure that the proper copper bus bars are installer for the desired configuration Reboot the UPS unit
04D	Parallel Communications Error	Warning	Periodic	Yellow Alert On	Ensure that the parallel cables are properly and securely connected Reboot the UPS unit
051	Output Short Circuit	Warning	Periodic	Yellow Alert On	Ensure that the proper copper bus bars are installer for the desired configuration Remove the loads and add back one at a time to detect load fault Reboot the UPS unit
054	Inverter Communications Error	Critical	Continuous	Red Alert On	Ensure that the proper copper bus bars are installer for the desired configuration Reboot the UPS unit
057	Inverter Initialization Error	Critical	Continuous	Red Alert On	Ensure that the proper copper bus bars are installer for the desired configuration Reboot the UPS unit
05A	Inverter Self-Test Error	Critical	Continuous	Red Alert On	Ensure that the proper copper bus bars are installer for the desired configuration Reboot the UPS unit

Fault Code	Fault Description	Fault Type	Buzzer	LED	Action to Take
05E	Inverter DC Offset Over Voltage	Critical	Continuous	Red Alert On	Ensure that the proper copper bus bars are installed for the desired configuration Reboot the UPS unit
061	DC Bus Voltage Abnormal	Critical	Continuous	Red Alert On	Reboot the UPS unit
063	Power Supply Error	Critical	Continuous	Red Alert On	Reboot the UPS unit
064	Inverter Power Supply Error	Critical	Continuous	Red Alert On	Ensure that the proper copper bus bars are installed for the desired configuration Reboot the UPS unit
067	Inverter Over Temperature	Critical	Continuous	Red Alert On	Ensure that Ambient operating temperature is at or below 40C Reduce the load Check if the battery group is set correctly Remove ventilation obstructions Reboot the UPS unit
068	Load Sharing Error	Warning	Periodic	Yellow Alert On	Ensure that the parallel output terminals are properly connected Reboot the UPS unit
06B	Inverter Fuse Fault	Critical	Continuous	Red Alert On	Ensure that the proper copper bus bars are installed for the desired configuration Reboot the UPS unit
071	Bypass SCR Short Circuit	Critical	Continuous	Red Alert On	Reboot the UPS unit
074	Bypass SCR Open Circuit	Critical	Continuous	Red Alert On	Reboot the UPS unit
077	Back Feed On Bypass	Critical	Continuous	Red Alert On	Reboot the UPS unit
101	Input Wiring Error	Warning	Periodic	Yellow Alert On	Ensure that the source input power is within the UPS operating range Reboot the UPS unit

Fault Code	Fault Description	Fault Type	Buzzer	LED	Action to Take
102	Neutral Missing Detected	Warning	Periodic	Yellow Alert On	Ensure that the source input neutral is properly connected Reboot the UPS unit
103	Battery Over Voltage	Warning	Periodic	Yellow Alert On	Reboot the UPS unit
104	Battery Low Voltage Pre-warning	Warning	Periodic	Yellow Alert On	Battery is nearly depleted, allow time for battery to recharge
105	Battery Reversal Detected	Warning	Periodic	Yellow Alert On	Ensure that the EBP connector is properly and securely connected Reboot the UPS unit
106	Battery Depleted	Warning	Periodic	Yellow Alert On	Battery is depleted, allow time for battery to recharge
107	EBP Error	Warning	Periodic	Yellow Alert On	Reboot the UPS unit
108	No Battery Detected	Warning	Periodic	Yellow Alert On	Ensure that the EBP connector is properly and securely connected
109	Input Phase Reversal Detected	Warning	Periodic	Yellow Alert On	Ensure that the input wires are properly and securely connected
10A	Input Neutral not Detected	Warning	Periodic	Yellow Alert On	Ensure that the source input neutral is properly connected Reboot the UPS unit
10B	Input Frequency Abnormal	Warning	Periodic	Yellow Alert On	Ensure that the input frequency is within the normal operating range of the UPS
10C	Input Voltage Abnormal	Warning	Periodic	Yellow Alert On	Ensure that the input voltage is within the normal operating range of the UPS
10D	PFC Communications Error	Critical	Continuous	Red Alert On	Reboot the UPS unit
10E	Main Input Lost	Warning	Periodic	Yellow Alert On	Ensure that the input voltage and frequency are within the normal operating range of the UPS
10F	Rectifier Setting Incorrect	Critical	Continuous	Red Alert On	Reboot the UPS unit
111	Input Relay Won't Open	Critical	Continuous	Red Alert On	Reboot the UPS unit

Fault Code	Fault Description	Fault Type	Buzzer	LED	Action to Take
114	Input Relay Won't Close	Critical	Continuous	Red Alert On	Reboot the UPS unit
121	Parallel Communications Error	Warning	Periodic	Yellow Alert On	Ensure that the parallel cables are properly and securely connected Reboot the UPS unit
125	Inverter Overload	Warning	Periodic	Yellow Alert On	Reduce the load on the output of the UPS
126	Inverter cannot Synchronize	Critical	Continuous	Red Alert On	Ensure that the input frequency is stable (not varying in frequency) and within the normal operating range of the UPS
127	Output Error	Critical	Continuous	Red Alert On	Reboot the UPS unit
128	Bypass Over Current	Warning	Periodic	Yellow Alert On	Reduce the Load on the output of the UPS
129	Inverter Communication Error	Critical	Continuous	Red Alert On	Ensure that the proper copper bus bars are installer for the desired configuration Reboot the UPS unit
12A	Inverter Settings Incorrect	Critical	Continuous	Red Alert On	Ensure that the proper copper bus bars are installer for the desired configuration Reboot the UPS unit
12B	Input Bypass Relay Won't Open	Critical	Continuous	Red Alert On	Reboot the UPS unit
12E	Input Bypass Relay Won't Close	Critical	Continuous	Red Alert On	Reboot the UPS unit
131	Bypass Unable to Trace	Warning	Periodic	Yellow Alert On	Ensure that the input frequency connected to the Bypass is stable and within the normal operating range of the UPS
132	Bypass Not Available	Warning	Periodic	Yellow Alert On	Ensure that the input voltage and frequency connected to the bypass are within the normal operating range of the UPS

Fault Code	Fault Description	Fault Type	Buzzer	LED	Action to Take
133	Excessive Switching to Bypass	Warning	Periodic	Yellow Alert On	Clear Fault on Fault Clear Page Reboot the UPS unit
134	Bypass Voltage Reversal	Warning	Periodic	Yellow Alert On	Ensure that the input wires are properly and securely connected
185	Battery Self-Test Error	Warning	Periodic	Yellow Alert On	Ensure that EBP is properly and securely connected Ensure the battery is fully charged The rerun Battery Test
186	Bat Sensor Disconnect	Warning	Periodic	Yellow Alert On	Ensure that the BAT_T cable is properly connected between the UPS and the first EBP
187	Battery High Temperature Alarm	Critical	Continuous	Red Alert On	Ensure that the BAT_T cable is properly connected between the UPS and EBP Ensure that the EBP ambient operating temperature is at or below 40°C
18A	EEPROM Error	Critical	Continuous	Red Alert On	Reboot the UPS unit
18E	Parallel Communications Error	Warning	Periodic	Yellow Alert On	Ensure that the parallel cables are properly and securely connected Reboot the UPS unit
18F	Battery Over Temperature Critical	Critical	Continuous	Red Alert On	Ensure that the BAT_T cable is properly connected between the UPS and EBP Ensure that the EBP ambient operating temperature is at or below 40°C Disconnect the EBP for a while and then reconnect
190	Ambient Temperature Abnormal	Warning	Periodic	Yellow Alert On	Ensure that the ambient operating temperature is within the UPS temperature operating range

Fault Code	Fault Description	Fault Type	Buzzer	LED	Action to Take
191	Battery Low Temperature Alarm	Warning	Periodic	Yellow Alert On	Ensure that the BAT_T cable is properly connected between the UPS and EBP Ensure that the EBP ambient operating temperature is at or above 0°C
19B	Battery Check Alarm	Warning	Periodic	Yellow Alert On	Reboot the UPS unit

Appendix B: Troubleshooting

If the UPS is not properly functioning, it may be related to improper installation, wiring or operation. Follow the troubleshooting procedures below as a first pass analysis of the problem.

No.	Problem	Possible reason	Solution
1	The source is connected but the UPS will not power ON.	<p>Input power source is not providing power.</p> <p>Input voltage and/or frequency is too low or too high.</p> <p>The input breaker of the UPS is not turned ON (if applicable).</p>	<p>With a multimeter measure the source voltage and frequency connected to the UPS input to ensure it is in the input range of the UPS.</p> <p>Check that the UPS input breaker is turned ON.</p>
2	The source is in range, but the Normal LED on the UPS does not light, and the UPS is operating in the battery state.	<p>The input breaker of the UPS is not turned ON (if applicable).</p> <p>The input cable is not securely connected.</p>	<p>Turn ON the input breaker.</p> <p>Make sure the input cable is securely connected.</p>
3	The UPS does not indicate any failure, but there is no output voltage.	<p>The output breaker is not turned ON (if applicable).</p> <p>The output cable is not securely connected.</p>	<p>Turn ON the output breaker.</p> <p>Make sure the output cable is securely connected.</p>
4	The Normal LED is flashing.	The double conversion UPS has been setup for ECO mode (the UPS is operating in the ECO state).	This is a valid mode; ensure you want the UPS operating in the ECO state.

5	Buzzer beeps every second and the display shows “output overload”.	The load on the output of the UPS exceeds the capability of the UPS.	Remove some load. Use a higher kVA UPS for this deployment.
6	The UPS only works in bypass state.	<p>The UPS is set to ECO mode.</p> <p>The transfer times to Bypass state exceeded the limit (10 x in an hour).</p>	<p>Set the UPS working mode to Normal Mode (non-parallel).</p> <p>Reset the times of transferring to bypass by clearing all the faults or re-starting the UPS.</p>
7	Cannot Cold start	<p>Battery breaker is not properly closed.</p> <p>Battery is too low.</p> <p>Battery quantity set incorrectly.</p> <p>Input breaker on the rear panel not switched ON.</p> <p>5-10kVA Lithium Only: Battery Capacity is too low.</p>	<p>Switch ON the battery breakers.</p> <p>Recharge the battery and retry.</p> <p>Power ON the UPS with AC to set the battery quantity.</p> <p>Switch ON the input breaker.</p> <p>5-10kVA Lithium Only : Power the UPS Normally, then let the Battery synch and charge to a level above 10%.</p>

8	Battery Maintenance Pop-Ups are occurring	Time from Battery Installation Date to current date has exceeded threshold.	<p>Change the Battery Installation Date in the Advanced Settings > Battery menu to a later date and save this configuration.</p> <p>Adjust the amount of days set for the Battery Replacement Notification and Alarm settings. (These are subtractive from the maximum threshold. Ex. For VRLA batteries, the design life threshold is 1095 (3 years) from installation date. If Battery Replacement notification is set for 365, the notification will appear $1095 - 365 = 730$ days (2 years) after the installation date.)</p>
9	Battery Installation Date is not saving correctly	LCD may need to be configured to a different orientation	Set the LCD to horizontal orientation via the Basic Settings > Display menu. Then attempt to adjust and save the installation date.
10	Battery did not last long after initial install.	Battery capacity may have degraded some amount in storage	After initial installation of the UPS and battery, let the UPS charge the battery fully for the recommended time to synchronize the battery state-of-capacity and to support the full rated load.

11	Lithium EBP Alarm light is illuminated.	<p>Cables may not be connected properly.</p> <p>Multiple EBPs have the same address.</p>	<p>Check that the EBP COM cable is connected from the UPS to the battery pack COM port. If using multiple battery packs check that the COM cable is connected between them as well as the CAN cable between them.</p> <p>If using multiple EBPs, check that the address DIP switch on the rear panel is set to a unique value on each EBP.</p>
----	---	--	--

If the troubleshooting procedures do not solve the problem, contact Panduit Customer Support at cs@panduit.com or 1-800-777-3300 with the following information.

- Product SKU and serial number.
- Detailed explanation of the fault, such as LCD display info, LED lights status, etc.

Appendix C: State Transitions Based on External Events

5-10kVA Double Conversion			
UPS Operating State	EU - Range	NA - Range	Comments
Normal , CF or Gen state Voltage Range	Full load: 176 ~ 264 Vac Half load: 110 ~ 285 Vac	Full load: 176 ~ 264 Vac Half load: 110 ~ 285 Vac	If the input voltage goes outside of the range, the UPS will transition to Battery state.
ECO state Voltage Range	Upper limit: 220V: +5%/+10%/+15%/+20% 230V: +5%/+10%/+15% 240V: +5%/+10% Lower limit: 220V: -5%/-10%/-15%/-20% 230V: -5%/-10%/-15%/-20%/-25% 240V: -5%/-10%/-15%/-20%/-25%	Upper limit: 208V: +5%/+10%/+15%/+20%/+25% 240V: +5%/+10% Lower limit: 208V: -5%/-10%/-15% 240V: -5%/-10%/-15%/-20%/-25%	If the input voltage goes outside of the settable range, the UPS will transition to the Normal state.
Bypass state Voltage Range	Upper limit: 220V: +5%/+10%/+15%/+20% 230V: +5%/+10%/+15% 240V: +5%/+10% Lower limit: 220V: -5%/-10%/-15%/-20% 230V: -5%/-10%/-15%/-20%/-25% 240V: -5%/-10%/-15%/-20%/-25%	Upper limit: 208V: +5%/+10%/+15%/+20%/+25% 240V: +5%/+10% Lower limit: 208V: -5%/-10%/-15% 240V: -5%/-10%/-15%/-20%/-25%	If the input voltage goes outside of the settable range, the UPS will shutdown the output.
Normal state Frequency Range	50/60 ±10%Hz		If the input frequency goes outside of this range, the UPS will transition to the Battery state.
CF state Frequency Range	40 ~ 70Hz		If the input frequency goes outside of this range, the UPS will transition to the Battery state. In CF Mode, the UPS is derated to 80%.
Gen state Frequency Range	40 ~ 70Hz		If the input frequency goes outside of 50 / 60 ± 10% Hz, the UPS is derated to 75% until the input frequency goes outside of this range, then the UPS will transition to the Battery state.
ECO state Frequency Range	50/60 ±1%/2%/4%/5%/10%(settable) Hz		If the input frequency goes outside of the settable range, the UPS will transition to the Normal state.
Bypass state Frequency Range	50/60 ±1%/2%/4%/5%/10%(settable)Hz		If the input voltage goes outside of the settable range, the UPS will shutdown the output.
Normal state Overload	105%~125%: 5 mins; 125%~130%: 1 min; >130%: 200 msec;		Overload Alarm for time specified and then the UPS will transition to the Bypass state.
CF or Gen state Overload	100%: 0 secs		Once the UPS reaches full load, the UPS will shutdown the output.
Battery state Overload	105%~125%: 1 mins; 125%~130%: 30 secs; >130%: 200 msec;		Overload Alarm for time specified and then the UPS will shutdown the output.
ECO or Bypass state Overload	105%~110%: overload alarm indefinitely; 110%~130%: 1 min; >130%: 200 msec;		Overload Alarm for time specified and then the UPS will shutdown.

10-20kVA Double Conversion		
UPS Operating State	Range	Comments
Normal or CF state Voltage Range	Full load: 305 ~ 485 Vac 40% load: 138 ~ 485 Vac	If the input voltage goes outside of the range, the UPS will transition to Battery state.
ECO state Voltage Range	220Vac: 209 ~ 231Vac 230Vac: 219 ~ 241Vac 240Vac: 228 ~ 252Vac	If the input voltage goes outside of the settable range, the UPS will transition to the Normal state.
ECO Mode while in the Normal State Voltage Range	220Vac: 214 ~ 226Vac 230Vac: 224 ~ 236Vac 240Vac: 233 ~ 247Vac	If the input voltage goes inside the settable range, the UPS will transition back to ECO state.
Bypass state Voltage Range	220Vac: +10%,+15%,+20%, +25% (settable) 230Vac: +10%,+15%, +20% (settable) 240Vac: +10%, +15% (settable) Min. voltage: -10%,-15%,-20%,-30%, -45% (settable)	If the input voltage goes outside of the settable range, the UPS will shut down.
Gen Mode Voltage Range	There is no Gen Mode selection	There is no Gen Mode selection
Normal state Frequency Range	40 ~ 70Hz	If the input frequency goes outside of this range, the UPS will transition to the Battery state.
CF state Frequency Range	40 ~ 70Hz	If the input frequency goes outside of this range, the UPS will transition to the Battery state.
ECO or Bypass state Frequency Range	50/60 ±1%/2%/4%/5%/10%(settable)Hz	If the input frequency goes outside of the settable range, the UPS will transition to the Normal state and then fix the output frequency at 50Hz or 60Hz.
Gen Mode Frequency Range	There is no Gen Mode selection because the UPS always operates with the wider input frequency range.	There is no Gen Mode selection because the UPS always operates with the wider input frequency range.
Normal state Overload	105% ~ 110%: 60 mins; 110% ~ 125%: 10 mins; 125% ~ 150%: 1 min; >150%: 500 msec;	Overload Alarm for time specified and then the UPS will transition to the Bypass state.
CF state Overload	105% ~ 110%: 60 mins; 110% ~ 125%: 10 mins; 125% ~ 150%: 1 min; >150%: 500 msec;	Overload Alarm for time specified and then the UPS will shutdown.
Battery state Overload	105% ~ 110%: 60 mins; 110% ~ 125%: 10 mins; 125% ~ 150%: 1 min; >150%: 500 msec;	Overload Alarm for time specified and then the UPS will shutdown.
ECO or Bypass State Overload	≤130%: overload alarm indefinitely; 130% ~ 150%: 10 mins; 150% ~ 200%: 1 mins; >200%: 1 secs; 10x the rated current: 100 msec;	Overload Alarm for time specified and then the UPS will shutdown.
Gen Mode Overload	There is no Gen Mode selection.	There is no Gen Mode selection.

Appendix D: Maintenance and Storage

Maintenance

The repair and replacement of any components in the UPS system must be performed by qualified personnel. If the battery cartridge has exceeded its service life (about 3-5 years at 25°C for VRLA batteries, 8-10 years at 25°C for Lithium), contact Panduit Sales for qualified replacements. Refer to the SmartZone UPS Installation Manual for details on replacing the battery cartridges.



Used battery cartridges should be properly disposed per local regulations. Refer to the Panduit Support Website at: <https://www.panduit.com/en/support/ups-battery-recycling.html>

Storage/Transportation

Before storing the UPS or EBP units with battery cartridges or replacement battery cartridges, charge the cartridge for 5 hours with no load. Disconnect the battery cartridge(s) from the system (see the SmartZone UPS Installation Manual). Store/transport the product in the upright orientation in normal packaging in a dry environment. During storage, recharge and maintain according to the following table:

Storage temperature	Charging interval	Charging time
-25°C - 40°C	Every 3 months	1-2 hours
40°C - 45°C	Every 2 months	1-2 hours

Note: Environmental factors affect battery life. High ambient temperature, high humidity, low-voltage, and frequent, short-term discharges will shorten the battery life.

Appendix E: Configuration Options

The following options should be configured on a newly installed UPS System. These are the minimum options that should be configured after initial power up of the system. Other options could be configured later. However, if the system being powered up is a parallel system, then the parallel configurations must also be configured at initial power up. Please refer to the [Parallel Mode Setup and Startup](#) section under Basic Operations for the procedures for starting up a parallel system.

Display Menu Path	Parameters	Default Value	Options	Description
Setup/ Basic	Language	English	English, Simplified Chinese	Select the language required for the UPS Display Interface. Language options vary by model and firmware version.
	Password	123456	6 digits	The password must be 6 characters, numbers only. For security, this password should be changed after initial power up.
	Date & Time	2022-01-01 & 07:00:00	YYYY-MM-DD, HH:MM:SS	Enter the current date and time (Note: time is 24-hour format).
Setup/ Advanced	Output Setup	Depends on SKU (NA = 208V, EU = 230V)	Depends on SKU	Set the output voltage for the UPS. This setting can only be changed when the UPS output is off.
	Battery Install Date	UPS Manuf. Date	YY-MM-DD	This setting will set the start date to determine when the battery notification and alarm will activate. It is suggested to change this to the date of installation to better monitor battery replacement timing..

Configure these settings at any time, using the UPS Display Interface or the Web UI.

Display Menu Path	Parameters	Default Value	Options	Description
Setup/ Basic	Language	English	English, Simplified Chinese	Select the language required for the UPS Display Interface. Language options vary by model and firmware version.
	Password	123456	6 digits	The password must be 6 characters, numbers only.

Display Menu Path	Parameters	Default Value	Options	Description
	Display Brightness	63	10–63	Set the brightness of the display (10-63).
	Display Backlight Timeout	60 secs	10-255 secs	To conserve energy, the LCD back light illumination turns off with no activity after this time. Full UPS Display Interface illumination returns when the UPS changes status because of an event or when the UPS Display Interface is pressed.
	Date & Time	2022-01-01 & 07:00:00	YYYY-MM-DD, HH:MM:SS	Enter the current date and time (Note: time is 24-hour format).
Setup/Advanced/System Setup	Working Mode	Normal	Normal, ECO, CF, Generator	Set up the UPS working mode (Gen mode on single-phase only).
	System Configuration	Single	Single, Parallel	Single means a single UPS in the system. Parallel means 2 to 4 UPSs in a system (available only on the 3-Phase UPS).
	Input: Output Phase	3:3	3:3, 3:1	3-Phase IN and 3-Phase OUT or 3-Phase IN and single-Phase OUT (available only on the 3-Phase UPS).
Setup/Advanced/Parallel Setup (3-phase units, 1-Phase Lithium units only)	Parallel ID	1	1, 2, 3, 4	Each UPS in a parallel system must have a unique ID.
	Parallel Basic Units	2	2, 3, 4	This is the number of UPS units in the system.
	Parallel Redundancy Units	0	0, 1, 2, 3	When the parallel system is setup for a redundancy parallel configuration, this is the number of redundant UPS units in the system (0 means no redundancy).
Setup/Advanced/Output Setup	Output Frequency	Auto	Auto, 50Hz, 60Hz	Set the output frequency for the UPS.
	Output Voltage	Depends on SKU (NA = 208V, EU = 230V)	Depends on SKU	Set the output voltage for the UPS. This setting can only be changed when the UPS output is off.
	Inverter Voltage Adjustment	0.0%	-5% to +5% (Increments of 0.5%)	Used for fine tuning the output on UPS units in the parallel system (available on 1-Phase Lithium UPS and 3-Phase UPS only).

Display Menu Path	Parameters	Default Value	Options	Description
Setup/ Advanced/ Battery Setup	Battery Group	1	1 to 5 (VRLA) 1 to 4 (Lithium) or 1 to 8 (3-P VRLA)	Set the number of EBP units connected to the UPS (single-phase VRLA UPS is 1-5, single-phase Lithium UPS is 1-4, and 3-Phase UPS is 1-8).
	Boost/Float Conversion	0 Months	0 to 24	Used for battery life optimization (available only on the 3-Phase UPS).
	Cell Float Voltage	2.25V	2.20-2.29V	Used for battery life optimization (available only on the 3-Phase UPS).
	Cell Boost Voltage	2.35V	2.30-2.40V	Used for battery life optimization (available only on the 3-Phase UPS).
	Boost Charge Setting	Enable	Enable, Disable	Used for battery life optimization (available only on the 3-Phase UPS).
	No Battery Warning	Enable	Enable, Disable	Allows warning to be disabled when there is no battery connected to the UPS.
	Shared Battery	Disable	Enable, Disable	For parallel system, this allows the charging circuit in multiple UPS units to charge the batteries in the system (available only on the 3-Phase UPS).
	EOD Group 2	1.75 (VRLA) 50% (Lithium)	1.75, 1.84, 1.92 (VRLA) 0, 25, 50% (Lithium)	Set Group 2 outlets to a battery cell voltage (VRLA) or SoC % (Li) that will cause the outlets to automatically turn off when the UPS is in the battery state (available only in single-phase UPS units).
	EOD Group 3	1.75 (VRLA) 50% (Lithium)	1.75, 1.84, 1.92 (VRLA) 0, 25, 50% (Lithium)	Set Group 3 outlets to a battery cell voltage (VRLA) or SoC % (Li) that will cause the outlets to automatically turn off when the UPS is in the battery state (available only in single-phase EU UPS units).
	Install Date	Date Built	Year, Month, Day	This setting will set the start date to determine when the battery notification and alarm will activate.
Replacement Notification	372 days	0 - 730	This is the number of days prior to 3 years (1095 days, VRLA) or 8 years (2920 days, Lithium) that the battery replacement notification will be activated. This notification should be set to allow for a new battery to be ordered and replaced before the battery replacement alarm is activated.	

Display Menu Path	Parameters	Default Value	Options	Description
	Replacement Alarm	365 days	0 - 365	This is the number of days prior to 3 years (1095 days) that the battery replacement alarm will be activated. This alarm should be set based on your company's policies for replacing UPS batteries. The expected life of a VRLA battery is 3 years, but your company's policy may be shorter than this.
Setup/ Advanced/ Bypass Setup	Voltage Lower Limit	Based on SKU (NA S-P = -15%, EU S-P = -20%, EU 3-P = -15%)	-25%, -20%, -15%, -10%, -5%	Set the acceptable bypass lower limit voltage represented as a percentage of the nominal input voltage. Note: This should be set based on the loads input voltage range.
	Voltage Upper Limit	Based on SKU (NA VRLA S-P = 15%, EU VRLA S-P = 15%, EU VRLA 3-P = 10%)	10%, 15%, 20%, 25%	Set the acceptable bypass upper limit voltage represented as a percentage of the nominal input voltage. Note: This should be set based on the loads input voltage range.
	Frequency Tracking Range	10%	1%, 2%, 4%, 5%, 10%	Set the acceptable bypass frequency range represented as a percentage of the nominal input frequency range. Note: This should be set based on the loads input frequency range.
Setup/ Advanced/ Dry Contact Setup	IN 01	Close	Close, INV ON, INV OFF, BATT Fault, Gen, User Alarm 3, User Alarm 4, Forbidden ECO, Force INV OFF, Input Switch, Bypass Switch, BATT Switch, BATT Trip, BATT Ground, Thunder, EPO	Select the identity of the second input dry contact between pins 3 and 5 (available on the 3-phase UPS only). Close for the assignment means nothing is assigned. Refer to Appendix F: 10 to 20kVA Dry Contact Port Definitions and Assignments for the definitions of these assignments.

Display Menu Path	Parameters	Default Value	Options	Description
	IN 02	Close	Same as IN 01	<p>Select the identity of the second input dry contact between pins 3 and 5 (available on the 3-phase UPS only).</p> <p>Close for the assignment means nothing is assigned. Refer to Appendix F: 10 to 20kVA Dry Contact Port Definitions and Assignments for the definitions of these assignments.</p>
	IN 03	Close	Same as IN 01	<p>Select the identity of the third input dry contact between pins 5 and 6 (available on the 3-phase UPS only).</p> <p>Close for the assignment means nothing is assigned. Refer to Appendix F: 10 to 20kVA Dry Contact Port Definitions and Assignments for the definitions of these assignments.</p>
	IN 04	Close	Same as IN 01	<p>Select the identity of the input fourth dry contact between pins 7 and 9 (available on the 3-phase UPS only).</p> <p>Close for the assignment means nothing is assigned. Refer to Appendix F: 10 to 20kVA Dry Contact Port Definitions and Assignments for the definitions of these assignments.</p>

Display Menu Path	Parameters	Default Value	Options	Description
	OUT 01	Normally Open/Close	Normally Open, Normally Closed / Close, UPS Warning, Online Mode, Battery Mode, Bypass Mode, INV Overload, Fan Fault, Battery Fault, Battery Disconnected, Battery Low Voltage, Main Abnormal, Bypass Not Available, EPO, Maintenance Bypass Mode, Parallel Communication Fault, ECO Mode	<p>Select the sense and identity of the first output dry contact between pins 1 and 2 (available on the 3-phase UPS only).</p> <p>Normally open means the output is active when it closes. Normally closed means output is active when it opens.</p> <p>Close for the assignment means nothing is assigned. Refer to Appendix F: 10 to 20kVA Dry Contact Port Definitions and Assignments for the definitions for these assignments.</p>
	OUT 02	Normally Open/Close	Same as OUT 01	<p>Select the sense and identity of the second output dry contact between pins 3 and 4 (available on the 3-phase UPS only).</p> <p>Normally open means the output is active when it closes. Normally closed means output is active when it opens.</p> <p>Close for the assignment means nothing is assigned. Refer to Appendix F: 10 to 20kVA Dry Contact Port Definitions and Assignments for the definitions for these assignments.</p>

Display Menu Path	Parameters	Default Value	Options	Description
	OUT 03	Normally Open/Close	Same as OUT 01	<p>Select the sense and identity of the third output dry contact between pins 5 and 6 (available on the 3-phase UPS only).</p> <p>Normally open means the output is active when it closes. Normally closed means output is active when it opens.</p> <p>Close for the assignment means nothing is assigned. Refer to Appendix F: 10 to 20kVA Dry Contact Port Definitions and Assignments for the definitions for these assignments.</p>
	OUT 04	Normally Open/Close	Same as OUT 01	<p>Select the sense and identity of the fourth output dry contact between pins 7 and 8 (available on the 3-phase UPS only).</p> <p>Normally open means the output is active when it closes. Normally closed means output is active when it opens.</p> <p>Close for the assignment means nothing is assigned. Refer to Appendix F: 10 to 20kVA Dry Contact Port Definitions and Assignments for the definitions for these assignments.</p>

Appendix F: 10 to 20kVA Dry Contact Port Definitions and Assignments

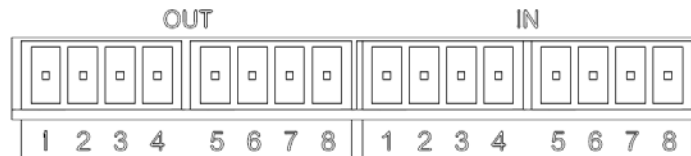

Input dry contact interface:

Port	Name	Function
IN-1	Input_contact_1	Input dry contact signal port (Select with LCD)
IN-2	GND	Input dry contact signal GND
IN-3	Input_contact_2	Input dry contact signal port (Select with LCD)
IN-4	GND	Input dry contact signal GND
IN-5	Input_contact_3	Input dry contact signal port (Select with LCD)
IN-6	GND	Input dry contact signal GND
IN-7	Input_contact_4	Input dry contact signal port (Select with LCD)
IN-8	GND	Input dry contact signal GND

Output Dry Contact Interface:

Port	Name	Function
OUT-1	Output_1_RLY	Output_1 dry contact port NC pin
OUT-2	Output_1_RLY_C	Output_1 dry contact port common pin
OUT-3	Output_2_RLY	Output_2 dry contact port NC pin
OUT-4	Output_2_RLY_C	Output_2 dry contact port common pin
OUT-5	Output_3_RLY	Output_3 dry contact port NC pin
OUT-6	Output_3_RLY_C	Output_3 dry contact port common pin
OUT-7	Output_4_RLY	Output_4 dry contact port NC pin
OUT-8	Output_4_RLY_C	Output4 dry contact port common pin

Input Dry Contact Assignments:

1. Close
 - The dry contact is unassigned.
2. INV ON
 - When input port is shorted (activated) it will cause the inverter in the UPS to turn ON.
3. INV OFF
 - When this input port is shorted (activated) it will cause the inverter in the UPS to turn OFF. This will not turn OFF the inverter if the bypass is not available. Use Force INV OFF.
4. BATT Fault
 - When this input port is shorted (activated) it indicates that the battery is damaged or not suitable to take the load anymore. When customer knows that battery is defective, this can be set to notify the UPS. Currently this setting will only set the alarm. Future features could prevent the battery from being charged and prevent the UPS from going to the battery state.
5. Generator
 - This is a signal that gets connected to a generator and will get shorted (activated) when the generator is operating, notifying the UPS that power is being sourced from a generator. This will be indicated on the display.
6. User Alarm3
 - This is a user-defined dry contact assignment. When this input port is shorted (activated), it indicates that the user-defined alarm will be displayed on the UPS.
7. User Alarm4
 - This is a user-defined dry contact assignment. When this input port is shorted (activated) it indicates that the user-defined alarm will be displayed on the UPS.
8. Forbidden ECO
 - When this input port is shorted (activated), it will not allow the UPS to be setup for ECO mode. This may be set by the user when there is a poor power grid, to prevent frequent switching between ECO mode and the Battery state. This setting will also trigger an alarm.
9. Force INV OFF
 - When this input port is shorted (activated), it will force the inverter in the UPS to turn OFF even if the bypass is not available. This will cause the UPS output to turn OFF.
10. Input Switch
 - This input dry contact setting is used with a customer added input main breaker that has trip sensing capabilities. This will present an alarm when the breaker is tripped.
11. Bypass Switch

- This input dry contact setting is used with a customer added input bypass breaker that has trip sensing capabilities. This will present an alarm when the breaker is tripped.
12. BATT Switch
13. This input dry contact setting is used with a customer added battery breaker that has position sensing capabilities. This will present an alarm when the breaker position is open.
14. BATT Trip
- This input dry contact setting is used with a customer added battery breaker that has trip sensing capabilities. This will present an alarm when the breaker is tripped.
15. BATT Ground
16. This input dry contact setting is used with a customer added ground sensing device that senses when the ground is not connected. This will present an alarm when the ground is not connected to the EBP.
17. Thunder
- This input dry contact setting is used with a customer added lightning detection device that senses when a lightning strike has occurred. This will present an alarm when a lightning strike has been detected.
18. EPO
- This input dry contact setting is used with a customer added emergency power off device that triggers when the device is activated. This will present an alarm when the EPO device has been activated. This setting could be used in addition to or instead of the EPO dedicated port on the back of the UPS.

Output Dry Contact Assignments:

19. Close
- The dry contact is unassigned.
20. UPS Warning
- When activated the UPS is indicating the UPS has a warning or critical alarm. This is an aggregation of all alarms.
21. Online Mode
- When activated the UPS is indicating it is operating in the Normal state.
22. Battery Mode
- When activated the UPS is indicating it is operating in the Battery state.
23. Bypass Mode
- When activated the UPS is indicating it is operating in the Bypass state.
24. INV Overload
- When activated the UPS is indicating it has detected an output Overload.
25. Fan Fault
- When activated the UPS is indicating it has detected an internal fan fault.

- 26. BATT Fault
 - When activated the UPS is indicating it has detected a battery fault.
- 27. BATT Disconnect
 - When activated the UPS is indicating it has detected that no battery is not connected to the system.
- 28. BATT Low Volt
 - When activated the UPS is indicating it has detected a low voltage on the battery. This is a warning that the battery is near the end of discharge.
- 29. Main Abnormal
 - When activated the UPS is indicating it has detected that the input main voltage and/or frequency is out of the specified input main voltage or frequency range for the UPS.
- 30. BYP Not Available
 - When activated the UPS is indicating it has detected that the input bypass voltage and/or frequency is out of the selected input bypass voltage or frequency range.
- 31. EPO
 - When activated the UPS is indicating it is in Emergency Power OFF state.
- 32. Maint. Mode
 - When activated the UPS is indicating it is in the Maintenance Bypass state.
- 33. Parallel Comm. Fault
 - When activated the UPS is indicating it has detected a Parallel communications fault.
- 34. ECO Mode
 - When activated the UPS is indicating it is operating in the ECO state.

Appendix G: 10 to 20kVA Back-feed Port Definition

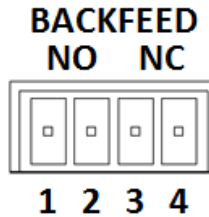

UPS	Instruction
Pin1/PIN2	Normally NO
Pin3/PIN4	Normally NC

Function description: These ports are driven to the opposite polarity when a Back-feed alarm is detected. The Back-feed alarm is activated when the inverter and bypass are enabled or connected to the load at the same time. The UPS will shut down when this event occurs.

Appendix H: 10 to 20kVA REPO Port Definition

Connection diagram:

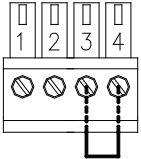
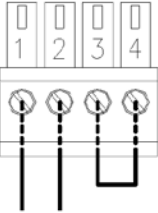
EPO	REPO Wiring Diagram	Function
EPO-NC (Default)		<ol style="list-style-type: none"> 1. Remove the wire jumper between terminals 3 & 4. 2. Connect wires from the Normally Closed (NC) contacts (terminal 3 & 4) of the NC EPO switch/relay. <p>The EPO function will be triggered when the wire jumper between pins 3 and 4 is removed or the EPO switch/relay changes to an open state.</p>
EPO-NO		<ol style="list-style-type: none"> 1. Keep the wire jumper between terminals 3 & 4. 2. Connect wires from the Normally Open (NO) contacts (terminals 1 & 2) of the NO EPO switch/relay. <p>The EPO function will be triggered when wire jumper between terminals 3 and 4 is removed or the EPO switch/relay connected between pins 1&2 contacts changes to a closed state.</p>

Connection between the remote EPO dry contact and UPS REPO port per the desired configuration above.

A remote emergency stop dry contact may be installed in a remote location and connected with simple wires to the REPO port per the desired configuration above.