

Unified Physical Infrastructure



Panduit

PViQ Networked and Environmental Monitored POU

PANDUIT®

MN027 Version 2.0

Copyright © 2010 PANDUIT Corp. All rights reserved. No part of this book shall be reproduced, stored in a retrieval system, or transmitted by any means, electronic, mechanical, photocopying, recording or otherwise, without written permission from *PANDUIT*. No patent liability is assumed with respect to the use of the information contained herein.

Although every precaution has been taken in the preparation of this book, *PANDUIT* assumes no responsibility for errors or omissions. Neither is any liability assumed for damages resulting from the use of the information contained herein.

Contents

SPECIFICATIONS	5
Overview	5
Environmental	5
Temperature	5
Humidity	5
Elevation	5
Electrical.....	5
Receptacle Ratings.....	5
Networking	6
Protocols	6
Ethernet Link Speed	6
Data Formats	6
EMC Verification	6
INSTALLATION	7
Guidelines	7
MOUNTING.....	8
"L" Bracket	8
Toolless Mounting Hardware	9
NETWORKED MONITORING	11
Network Overview	11
Default IP Address	11
Initial Setup	11
WEB INTERFACE	13
Overview	13
Sensors Page	13
Logging Page	15
Display Page.....	16
Alarms Page	16
Configuration Network Tab.....	17
Configuration Monitoring Tab	18
Configuration Diagnostics Tab	20
Configuration Event Log Tab.....	21
Configuration Admin Tab.....	22
UNIT CONFIGURATION	24
Network Configuration	24
Time and Date	25
E-Mail	25
Status Reports	26
SNMP	27
Accounts and Passwords.....	27
Telnet	29
Camera Configuration.....	29
Admin Information.....	29
Kilowatt-Hours Reset	30
XML File Backup.....	30
SSL Certificate Upload.....	30
ALARMS	31
Alarm Notifications	31
Alarm Types.....	31
Thresholds	31

SENSORS..... 33
 Overview 33
 Internal Sensors 33
 Remote Sensors 33
 Connecting Remote Sensors..... 33
 Data Logging and Display..... 34

ACCESSORIES 35
 Remote Display..... 35
 IP-Addressable Network Cameras 35
 Alternate Data Formats..... 35

SERVICE AND TECHNICAL SUPPORT 36
 Firmware Version 36
 Firmware Updates..... 36
 Resetting POU 36
 Service 36
 Technical Support..... 36

Specifications

Overview

The PViQ Networked and Environmental POU's are rack level POU's with circuit monitoring via a built-in web server in a self-contained unit. Web pages, including graphs, are generated by the unit to monitor power and environmental conditions within the cabinet. No software other than a web browser is required for operation and several data formats are available. In the PViQ Networked and Environmental POU's, built-in sensors monitor Voltage, Current, instantaneous and cumulative Power, as well as calculated Power Factor. Optional external sensors and network cameras are also available.

Environmental

Temperature

Operating:	10°C (50°F) min	45°C (113°F) max
Storage:	-25°C (-13°F) min	65°C (149°F) max

Humidity

Operating:	5% min 95% max	(non-condensing)
Storage:	5% min 95% max	(non-condensing)

Elevation

Operating:	0 m (0 ft) min	2000 m (6561 ft) max
Storage:	0 m (0 ft) min	15240 m (50000 ft) max

Electrical

See nameplate for unit ratings.

Receptacle Ratings

NEMA 5-15R or L5-15R	125 Volts, 15 Amp
NEMA 5-20R or L5-20R	125 Volts, 20 Amp
NEMA 6-20R or L6-20R	250 Volts, 20 Amp
IEC-320 C13	125/250 Volt, 15 Amp (North America) or 10 Amp (Global) ¹
IEC-320 C19	125/250 Volt, 20 Amp (North America) or 16 Amp (Global) ¹

¹ Given ratings are per receptacle bank

Networking

Protocols

HTTP, HTTPS (SSL/TLS), SMTP, POP3, ICMP, DHCP, TCP/IP, NTP, Telnet, Syslog

Ethernet Link Speed

10/100 Mbit; full-duplex

Data Formats

HTML, SNMP, CSV/Plain Text, XML

EMC Verification

This Class A device complies with part 15 of the FCC Rules. Operation is subject to the following two conditions: (1) This device may not cause harmful interference, and (2) this device must accept any interference received, including interference that may cause undesired operation.

This Class A digital apparatus complies with Canadian ICES-003.

Cet appareil numérique de la classe A est conforme à la norme NMB-003 du Canada.



Warning: Changes or modifications to this unit not expressly approved by the party responsible for compliance could void the user's authority to operate this equipment.

Installation

Guidelines

- If the POU is installed in a cabinet the ambient temperature of the rack should be no greater than 40°C.
- Install the POU such that the amount of airflow required for safe operation of equipment is not compromised.
- Mount the POU so that a hazardous condition is not achieved due to uneven mechanical loading.
- Follow nameplate ratings when connecting equipment to the branch circuit. Take into consideration the effect that overloading of the circuits might have on over-current protection and supply wiring.
- The POU relies on the building installation for protection from over-current conditions. A Listed circuit breaker is required within the building installation. The circuit breaker should be sized according to the POU's nameplate ratings and local/national electrical codes.
- Reliable earthing of rack-mount equipment should be maintained. Particular attention should be given to supply connections other than direct connections to the branch circuit. The POU must be connected to an earthed socket-outlet.
- The POU is intended for Restricted Access Locations only and only service personnel should install and access the POU.
- For pluggable equipment, install the POU so that the input plug or appliance coupler may be disconnected for service.
- Sequential power-up of devices powered by the POU is recommended to avoid high inrush current.



Caution: Disconnect all power cords before servicing.

Mounting

"L" Bracket

Affix Power Strip Mounting mounting brackets using #12-24 screws provided into tapped holes in the front or the sides of the post. Power Strip Mounting Brackets can also be mounted to the rear equipment rails.

To center the 66.25" vertical power strips:

- For 7 foot post racks - mount L-Bracket at RU spaces 03 and 43
- For 8 foot 4 post racks, mount L-Bracket at RU spaces 06 and 46 or spaces 07 and 47
- For 6.5 foot 4 post racks, flip bottom bracket 180° and mount L-bracket at RU spaces 02 and 40

Mount power strip between brackets.

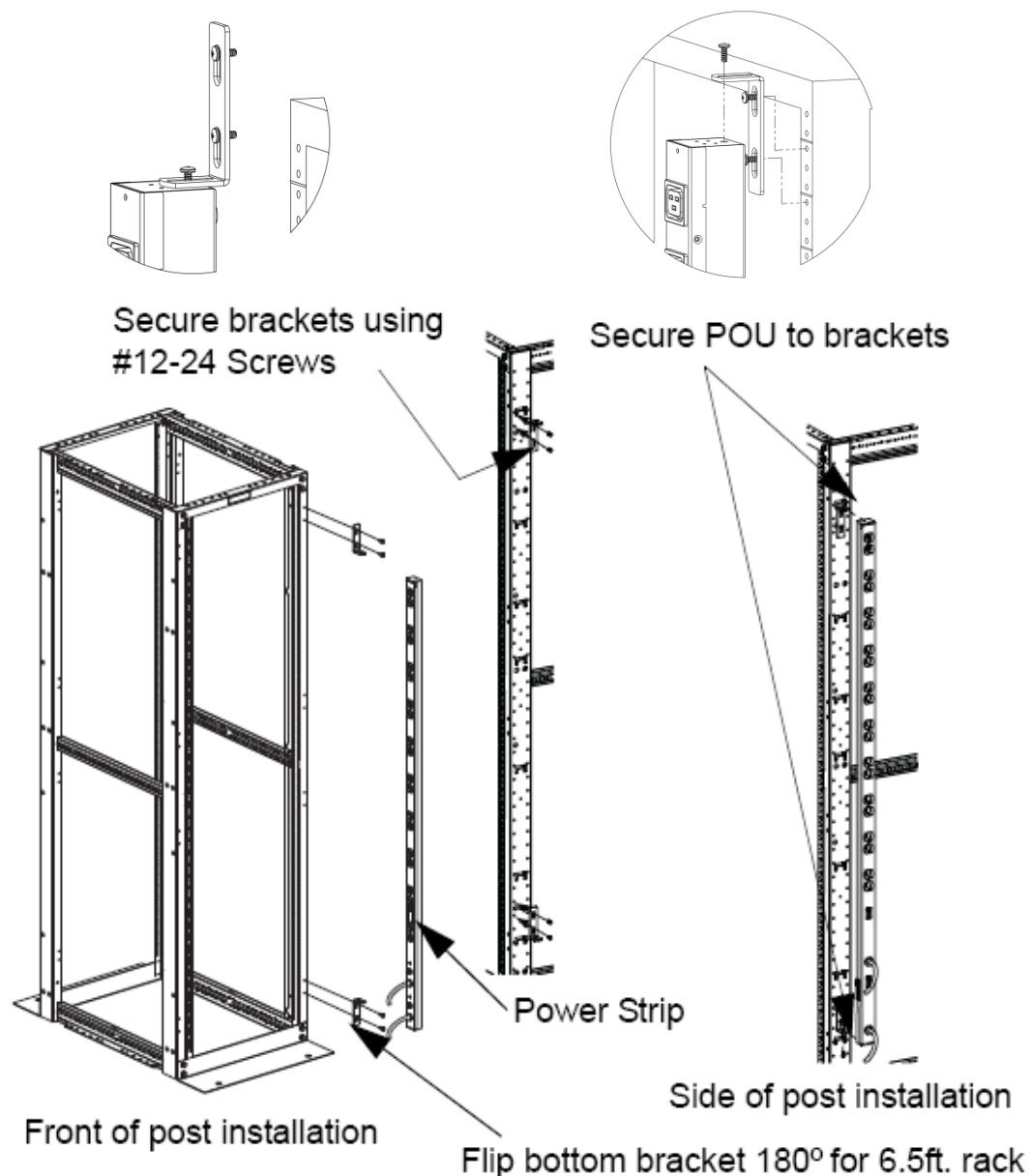

Toolless Mounting Hardware

Use toolless buttons with key-holed slots built into cabinet or with optional key-holed brackets.

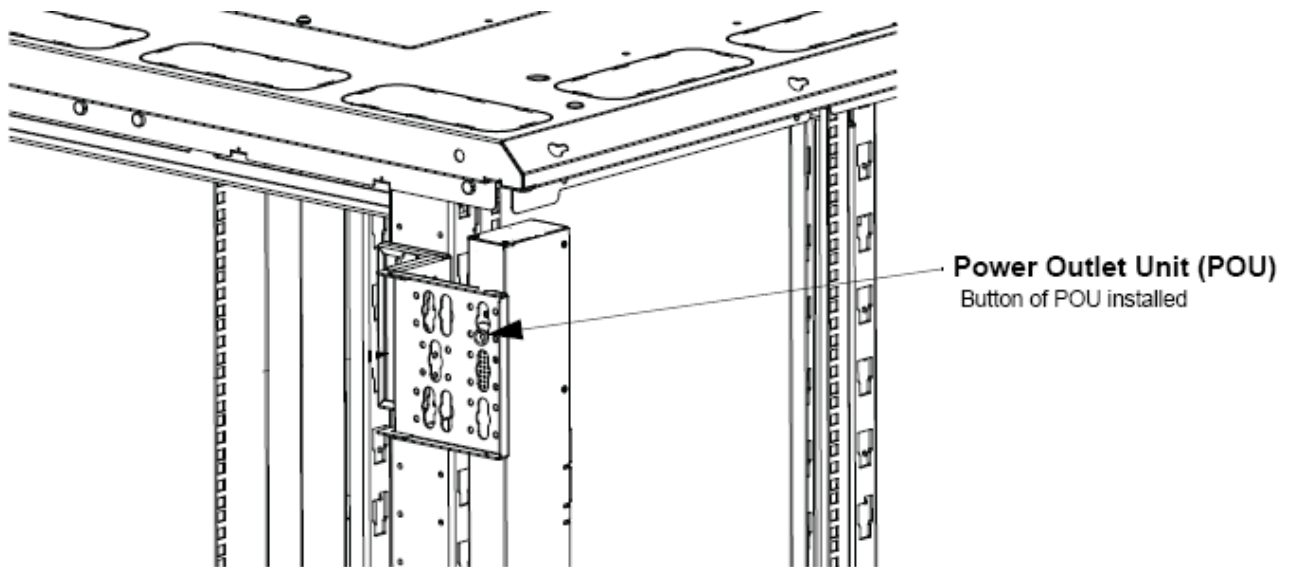
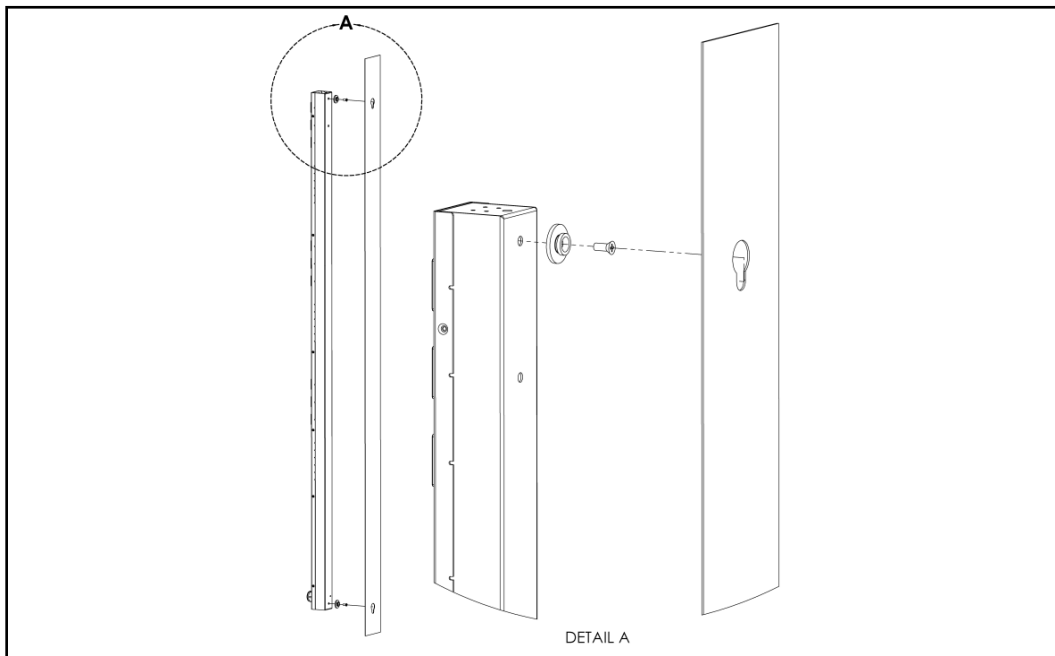

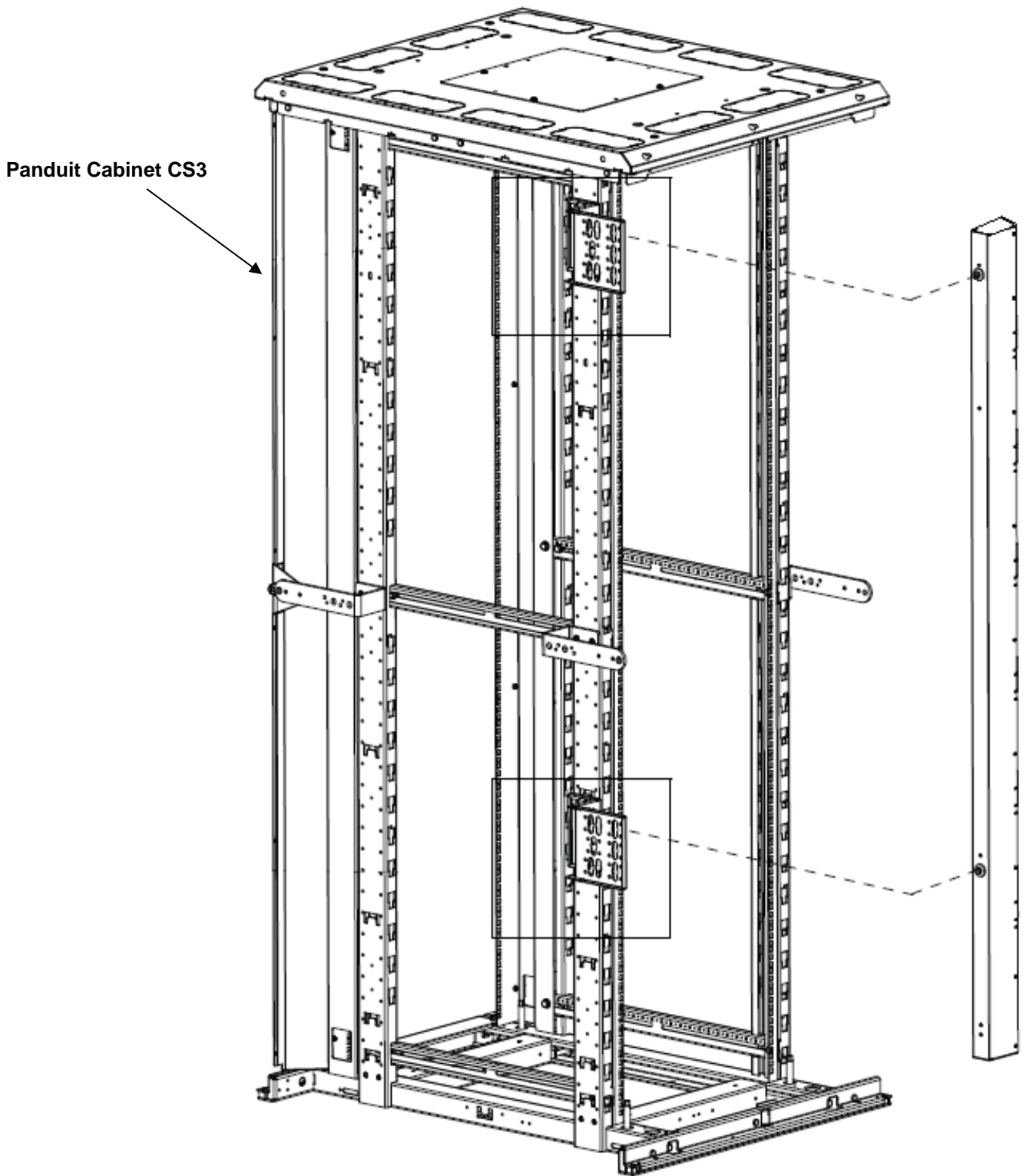

Networked Monitoring

Network Overview

This product comes preconfigured with a default IP address set. Simply connect to the POU and access the web page with your browser.

Default IP Address

The POU units have a default IP address for initial setup and access to the unit if the assigned address is lost or forgotten. Once an IP address is assigned to a unit, the default IP address is no longer active. To restore the default IP address, press and hold the reset button located below the network connector for 20 seconds. The idle and activity lights on the network connector will both light up when the IP address has been reset. The reset button is accessed through the white, circular hole located below the Ethernet jack.

Note: Pressing the reset button under the network connector will restore the default IP address and will also clear all password settings.

The Configuration page allows you to assign the network properties or use DHCP to connect to your network. Access to the unit requires the IP address to be known, so use of a Static IP or reserved DHCP is recommended. The default address is shown on the front of the unit:

IP Address: 192.168.123.123

Subnet Mask: 255.255.255.0

Gateway: 192.168.123.1

Initial Setup

1. Connect POU to your computer using a crossover cable.
2. On your computer, go to "Start > Settings > Control Panel > Network and Dial Up Connections."
3. Right Click on "Local Area Connection" and select "Properties."
4. Select the option to "Use the following IP address" and enter:

IP address: 192.168.123.1

Subnet mask: 255.255.255.0

Default gateway: 192.168.123.1²

5. Click "OK" twice.

You can now access the unit using your web browser at the permanent IP address of 192.168.123.1.

² In some configurations, leaving the gateway field blank may resolve connectivity issues.

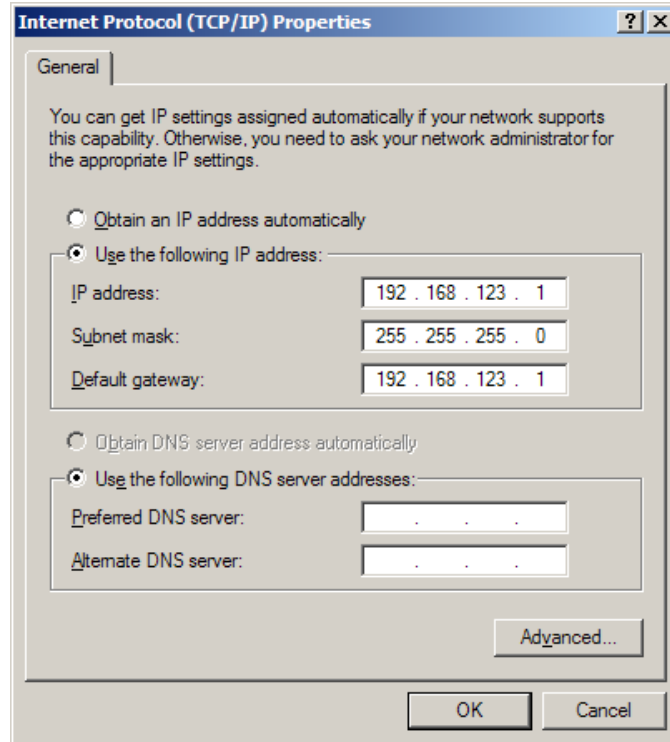

*Typical Network Card Settings for PC
or Laptop to connect to default IP address*

Web Interface

Overview

The unit is accessible via a standard, unencrypted HTTP connection as well as an encrypted HTTPS (SSL) connection. The following web pages are available:

Sensors Page

The front page, *Sensors*, gives both instantaneous and historical views of the unit's data. Real time readings are provided for all power strip and sensor data next to historical graphs.

Optional cameras may be added and their live snapshots are shown on this page. Plug-and-play sensors appear below the internal sensors when attached.

The menu bar allows access to the rest of the PDU's functionality.



PVIQ POU 1 Networked
 IP Address: 192.168.1.111
 Local Time: Thu, 12/09/10 13:30:08

PVIQ POU 1 Networked v3.5.6
All is well: 1 Alarms monitored

Sensors?

PVIQ POU 1 Networked
ID 018B6A081400004B

kWatt-hours [A]	1.11 kWh
Volts [A]	118.20 V _{rms}
Volts (Peak) [A]	118.40 V _{rms}
Amps [A]	0.02 A _{rms}
Amps (Peak) [A]	0.00 A _{rms}
Real Power [A]	0.00 Watts
Apparent Power [A]	2.4 Watts
Power Factor [A]	100.0 %
kWatt-hours [B]	
Volts [B]	118.70 V _{rms}
Volts (Peak) [B]	119.30 V _{rms}
Amps [B]	0.02 A _{rms}
Amps (Peak) [B]	0.00 A _{rms}
Real Power [B]	0.00 Watts
Apparent Power [B]	2.4 Watts
Power Factor [B]	100.0 %
kWatt-hours [C]	
Volts [C]	120.60 V _{rms}
Volts (Peak) [C]	120.70 V _{rms}
Amps [C]	0.02 A _{rms}
Amps (Peak) [C]	0.00 A _{rms}
Real Power [C]	0.00 Watts
Apparent Power [C]	2.4 Watts
Power Factor [C]	100.0 %

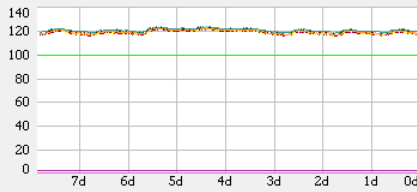

Temp Sensor
ID 2E00000246986428

Temperature (F) 77.22 °F

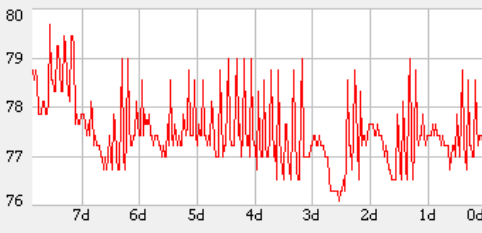

Logging Page

The *Logging* page allows the user to access the historical data by selecting the desired sensors and time range to be graphed. Selected sensor values are logged into the data file at a rate of one point per minute. Please note that although data is logged once per minute, all sensor data used in the real time display and alarm functions is read at least once every 15 seconds for internal sensors and once every 30 seconds for external sensors. Checked readings are displayed on the optional remote display module. Recorded data is available for download in a comma-separated values (CSV) file.

PANDUIT®

PViQ POU 1 Networked

IP Address: 192.168.1.111
Local Time: Thu, 12/09/10 13:33:35

PViQ POU 1 Networked v3.5.6

All is well: 1 Alarms monitored

Logging?

Sensor Measurement Data Graph

Time Range: 1 Month Maximum loggable time span: 7.76 days

PViQ POU 1 Networked				018B6A0814000048	
■	Volts [A]	117.80 V_{rms}	<input checked="" type="checkbox"/>	<input checked="" type="checkbox"/>	Logging Control: Normal
■	Volts (Peak) [A]	118.20 V_{rms}	<input checked="" type="checkbox"/>	<input checked="" type="checkbox"/>	Normal ▼
■	Amps [A]	0.02 A_{rms}	<input checked="" type="checkbox"/>	<input checked="" type="checkbox"/>	Normal ▼
	Amps (Peak) [A]	0.00 A_{rms}	<input type="checkbox"/>	<input type="checkbox"/>	Normal ▼
	Real Power [A]	0.00 Watts	<input type="checkbox"/>	<input type="checkbox"/>	Normal ▼
	Apparent Power [A]	2.4 Watts	<input type="checkbox"/>	<input type="checkbox"/>	Normal ▼
	Power Factor [A]	100.0 %	<input type="checkbox"/>	<input type="checkbox"/>	Normal ▼
Temp Sensor				2E00000246986428	
	Temperature (F)	77.22 °F	<input type="checkbox"/>	<input type="checkbox"/>	Logging Control: Normal

Reset Logs?

Save Changes

[Click here to download CSV log data](#)

Display Page

The *Display* page allows the user to assign friendly names to attached sensors as well as change the default temperature unit of measure for external sensors. The display page also allows the user to select between the default and classic web page layouts. The default interface displays a vertical menu bar to the left of the main window, while the classic interface displays a horizontal menu bar.

Alarms Page

The *Alarms* page allows the user to establish alarm conditions for each sensor reading. Alarm conditions can be established with either high or low trip thresholds. The alarms are displayed in different sections based on the device the alarm is associated with. Alarm options include a local Buzzer, Email and SNMP Trap.

The *Configuration* page has five sub-tabs; *Network*, *Monitoring*, *Diagnostics*, *Event Log*, and *Admin*. See Unit Configuration (page 24) for details.

Configuration Network Tab

The user can enter and update the network settings on the *Network* tab of the *Configuration* page. See Unit Configuration section for details.

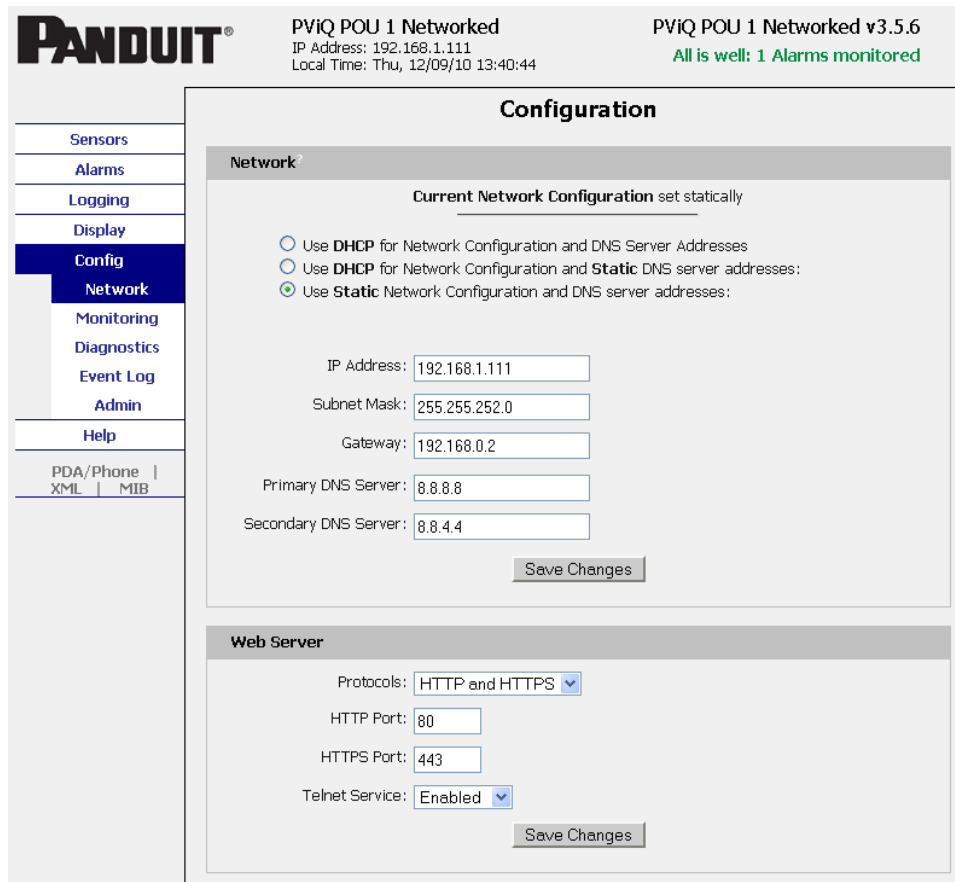

Configuration Monitoring Tab

The user can enter and update the email alert, SNMP, and camera settings on the *Monitoring* tab of the *Configuration* page. See Unit Configuration section for details.



PViQ POU 1 Networked
 IP Address: 192.168.1.111
 Local Time: Thu, 12/09/10 13:43:38

PViQ POU 1 Networked v3.5.6
All is well: 1 Alarms monitored

Configuration

E-mail

SMTP Server:

SMTP Port:

"From" E-mail Address:

	Send alarms to this recipient:	Always	Business Hours [?]	After Hours [?]	SMS [?]
To E-mail Address 1:	<input type="text"/>	<input checked="" type="radio"/>	<input type="radio"/>	<input type="radio"/>	<input type="checkbox"/>
To E-mail Address 2:	<input type="text"/>	<input checked="" type="radio"/>	<input type="radio"/>	<input type="radio"/>	<input type="checkbox"/>
To E-mail Address 3:	<input type="text"/>	<input checked="" type="radio"/>	<input type="radio"/>	<input type="radio"/>	<input type="checkbox"/>
To E-mail Address 4:	<input type="text"/>	<input checked="" type="radio"/>	<input type="radio"/>	<input type="radio"/>	<input type="checkbox"/>
To E-mail Address 5:	<input type="text"/>	<input checked="" type="radio"/>	<input type="radio"/>	<input type="radio"/>	<input type="checkbox"/>

POP3 Server:

POP3 Port:

Username:

Password:

Business Hours

Start Time:

End Time:

Sun	Mon	Tue	Wed	Thu	Fri	Sat
Week Days: <input type="checkbox"/>	<input checked="" type="checkbox"/>	<input checked="" type="checkbox"/>	<input checked="" type="checkbox"/>	<input checked="" type="checkbox"/>	<input checked="" type="checkbox"/>	<input type="checkbox"/>

Sensors

Alarms

Logging

Display

Config

Network

Monitoring

Diagnostics

Event Log

Admin

Help

PDA/Phone | XML | MIB

System Status E-Mail Reports

SNMP

SNMP Service: ▾

Read Community:

Listen port for GET:

Trap Community:

Write Community:

Trap Type: ▾

Trap IP Address:port 1:

Trap IP Address:port 2:

Initial SNMPV3 data

Unauthenticated User:

Authenticated Manager:

Manager Authentication Password:

Manager Privacy Password:

Trap User:

Trap Authentication Password:

Trap Privacy Password:

Reset User/Access NVRAM will occur during the finish page.

Cameras

Cam 1, IP Address:
Model: ▾

Cam 2, IP Address:
Model: ▾

Cam 3, IP Address:
Model: ▾

Cam 4, IP Address:
Model: ▾

Test SNMP Trap and E-Mail

Configuration Diagnostics Tab

The user can update the Syslog settings on the *Diagnostics* tab of the *Configuration* page.

PANDUIT®

PVIQ POU 1 Networked
 IP Address: 192.168.1.111
 Local Time: Thu, 12/09/10 13:46:07

PVIQ POU 1 Networked v3.5.6
All is well: 1 Alarms monitored

Configuration?

Syslog

Facility: LOCAL0

Daemon Address:port 1:

Syslog Configuration

Subsystems	Severity							
	emergency	alert	critical	error	warning	notice	inform	debug
os	<input checked="" type="checkbox"/>	<input checked="" type="checkbox"/>	<input checked="" type="checkbox"/>	<input checked="" type="checkbox"/>	<input type="checkbox"/>	<input type="checkbox"/>	<input type="checkbox"/>	<input type="checkbox"/>
lwip	<input checked="" type="checkbox"/>	<input checked="" type="checkbox"/>	<input checked="" type="checkbox"/>	<input checked="" type="checkbox"/>	<input type="checkbox"/>	<input type="checkbox"/>	<input type="checkbox"/>	<input type="checkbox"/>
socket	<input checked="" type="checkbox"/>	<input checked="" type="checkbox"/>	<input checked="" type="checkbox"/>	<input checked="" type="checkbox"/>	<input type="checkbox"/>	<input type="checkbox"/>	<input type="checkbox"/>	<input type="checkbox"/>
macphy	<input checked="" type="checkbox"/>	<input checked="" type="checkbox"/>	<input checked="" type="checkbox"/>	<input checked="" type="checkbox"/>	<input type="checkbox"/>	<input type="checkbox"/>	<input type="checkbox"/>	<input type="checkbox"/>
flashfl	<input checked="" type="checkbox"/>	<input checked="" type="checkbox"/>	<input checked="" type="checkbox"/>	<input checked="" type="checkbox"/>	<input type="checkbox"/>	<input type="checkbox"/>	<input type="checkbox"/>	<input type="checkbox"/>
webserv	<input checked="" type="checkbox"/>	<input checked="" type="checkbox"/>	<input checked="" type="checkbox"/>	<input checked="" type="checkbox"/>	<input type="checkbox"/>	<input type="checkbox"/>	<input type="checkbox"/>	<input type="checkbox"/>
spi0dev	<input checked="" type="checkbox"/>	<input checked="" type="checkbox"/>	<input checked="" type="checkbox"/>	<input checked="" type="checkbox"/>	<input type="checkbox"/>	<input type="checkbox"/>	<input type="checkbox"/>	<input type="checkbox"/>
device	<input checked="" type="checkbox"/>	<input checked="" type="checkbox"/>	<input checked="" type="checkbox"/>	<input checked="" type="checkbox"/>	<input type="checkbox"/>	<input type="checkbox"/>	<input type="checkbox"/>	<input type="checkbox"/>
host	<input checked="" type="checkbox"/>	<input checked="" type="checkbox"/>	<input checked="" type="checkbox"/>	<input checked="" type="checkbox"/>	<input type="checkbox"/>	<input type="checkbox"/>	<input type="checkbox"/>	<input type="checkbox"/>
setvars	<input checked="" type="checkbox"/>	<input checked="" type="checkbox"/>	<input checked="" type="checkbox"/>	<input checked="" type="checkbox"/>	<input type="checkbox"/>	<input type="checkbox"/>	<input type="checkbox"/>	<input type="checkbox"/>
dynweb	<input checked="" type="checkbox"/>	<input checked="" type="checkbox"/>	<input checked="" type="checkbox"/>	<input checked="" type="checkbox"/>	<input type="checkbox"/>	<input type="checkbox"/>	<input type="checkbox"/>	<input type="checkbox"/>
snmp	<input checked="" type="checkbox"/>	<input checked="" type="checkbox"/>	<input checked="" type="checkbox"/>	<input checked="" type="checkbox"/>	<input type="checkbox"/>	<input type="checkbox"/>	<input type="checkbox"/>	<input type="checkbox"/>
alarms	<input checked="" type="checkbox"/>	<input checked="" type="checkbox"/>	<input checked="" type="checkbox"/>	<input checked="" type="checkbox"/>	<input type="checkbox"/>	<input type="checkbox"/>	<input type="checkbox"/>	<input type="checkbox"/>
email	<input checked="" type="checkbox"/>	<input checked="" type="checkbox"/>	<input checked="" type="checkbox"/>	<input checked="" type="checkbox"/>	<input type="checkbox"/>	<input type="checkbox"/>	<input type="checkbox"/>	<input type="checkbox"/>
rtclock	<input checked="" type="checkbox"/>	<input checked="" type="checkbox"/>	<input checked="" type="checkbox"/>	<input checked="" type="checkbox"/>	<input type="checkbox"/>	<input type="checkbox"/>	<input type="checkbox"/>	<input type="checkbox"/>
sntp	<input checked="" type="checkbox"/>	<input checked="" type="checkbox"/>	<input checked="" type="checkbox"/>	<input checked="" type="checkbox"/>	<input type="checkbox"/>	<input type="checkbox"/>	<input type="checkbox"/>	<input type="checkbox"/>
dns	<input checked="" type="checkbox"/>	<input checked="" type="checkbox"/>	<input checked="" type="checkbox"/>	<input checked="" type="checkbox"/>	<input type="checkbox"/>	<input type="checkbox"/>	<input type="checkbox"/>	<input type="checkbox"/>
datalog	<input checked="" type="checkbox"/>	<input checked="" type="checkbox"/>	<input checked="" type="checkbox"/>	<input checked="" type="checkbox"/>	<input type="checkbox"/>	<input type="checkbox"/>	<input type="checkbox"/>	<input type="checkbox"/>
graphin	<input checked="" type="checkbox"/>	<input checked="" type="checkbox"/>	<input checked="" type="checkbox"/>	<input checked="" type="checkbox"/>	<input type="checkbox"/>	<input type="checkbox"/>	<input type="checkbox"/>	<input type="checkbox"/>
firmwar	<input checked="" type="checkbox"/>	<input checked="" type="checkbox"/>	<input checked="" type="checkbox"/>	<input checked="" type="checkbox"/>	<input type="checkbox"/>	<input type="checkbox"/>	<input type="checkbox"/>	<input type="checkbox"/>
msgcatlg	<input checked="" type="checkbox"/>	<input checked="" type="checkbox"/>	<input checked="" type="checkbox"/>	<input checked="" type="checkbox"/>	<input type="checkbox"/>	<input type="checkbox"/>	<input type="checkbox"/>	<input type="checkbox"/>

[PDA/Phone](#) | [XML](#) | [MIB](#)

Configuration Event Log Tab

The user can view the Event Log and update the Memory Syslog settings on the *Event Log* tab of the *Configuration* page.



PVIQ POU 1 Networked
IP Address: 192.168.1.111
Local Time: Thu, 12/09/10 13:51:35

PVIQ POU 1 Networked v3.5.6
All is well: 1 Alarms monitored

Configuration

NVRAM Event Log

[Click here to view NVM event log](#)

Memory Syslog

```

12/9/2010 13:51:34 setvars:vars_from_pairs: path=[/dyn_config_eventl
12/9/2010 13:51:34 setvars:vars_from_pairs: got vars_config_lock, 0
12/9/2010 13:46:06 setvars:vars_from_pairs: path=[/dyn_config_diagno
12/9/2010 13:46:06 setvars:vars_from_pairs: got vars_config_lock, 0
12/9/2010 13:43:37 setvars:vars_from_pairs: path=[/dyn_config_monito
12/9/2010 13:43:37 setvars:vars_from_pairs: got vars_config_lock, 0
12/9/2010 13:40:43 setvars:vars_reset_dhcp_status: resetting net_dhc
12/9/2010 13:40:43 setvars:vars_from_pairs: path=[/dyn_config.htm].
12/9/2010 13:40:43 setvars:vars_from_pairs: got vars_config_lock, 0
12/9/2010 13:39:13 setvars:vars_from_pairs: path=[/dyn_alarms.htm].
12/9/2010 13:39:13 setvars:vars_from_pairs: got vars_config_lock, 0
12/9/2010 13:38:24 setvars:vars_from_pairs: path=[/dyn_display.htm].
12/9/2010 13:38:24 setvars:vars_from_pairs: got vars_config_lock, 0
12/9/2010 13:33:34 setvars:vars_from_pairs: path=[/dyn_logging.htm].
12/9/2010 13:33:34 setvars:vars_from_pairs: got vars_config_lock, 0
12/9/2010 13:32:55 setvars:vars_from_pairs: path=[/dyn_sensors.htm].
12/9/2010 13:32:55 setvars:vars_from_pairs: got vars_config_lock, 0
12/9/2010 13:31:29 setvars:vars_from_pairs: path=[/dyn_sensors.htm].
12/9/2010 13:31:29 setvars:vars_from_pairs: got vars_config_lock, 0
12/9/2010 13:30:07 setvars:vars_from_pairs: path=[/dyn_sensors.htm].
                    
```

Memory Syslog

Subsystems	Severity							
	emergency	alert	critical	error	warning	notice	inform	debug
os	<input type="checkbox"/>	<input type="checkbox"/>	<input type="checkbox"/>	<input type="checkbox"/>	<input type="checkbox"/>	<input type="checkbox"/>	<input type="checkbox"/>	<input type="checkbox"/>
lwip	<input type="checkbox"/>	<input type="checkbox"/>	<input type="checkbox"/>	<input type="checkbox"/>	<input type="checkbox"/>	<input type="checkbox"/>	<input type="checkbox"/>	<input type="checkbox"/>
socket	<input type="checkbox"/>	<input type="checkbox"/>	<input type="checkbox"/>	<input type="checkbox"/>	<input type="checkbox"/>	<input type="checkbox"/>	<input type="checkbox"/>	<input type="checkbox"/>
macphy	<input type="checkbox"/>	<input type="checkbox"/>	<input type="checkbox"/>	<input type="checkbox"/>	<input type="checkbox"/>	<input type="checkbox"/>	<input type="checkbox"/>	<input type="checkbox"/>
flashfl	<input type="checkbox"/>	<input type="checkbox"/>	<input type="checkbox"/>	<input type="checkbox"/>	<input type="checkbox"/>	<input type="checkbox"/>	<input type="checkbox"/>	<input type="checkbox"/>
webserv	<input type="checkbox"/>	<input type="checkbox"/>	<input type="checkbox"/>	<input type="checkbox"/>	<input type="checkbox"/>	<input type="checkbox"/>	<input type="checkbox"/>	<input type="checkbox"/>
spi0dev	<input type="checkbox"/>	<input type="checkbox"/>	<input type="checkbox"/>	<input type="checkbox"/>	<input type="checkbox"/>	<input type="checkbox"/>	<input type="checkbox"/>	<input type="checkbox"/>
device	<input type="checkbox"/>	<input type="checkbox"/>	<input type="checkbox"/>	<input type="checkbox"/>	<input type="checkbox"/>	<input type="checkbox"/>	<input type="checkbox"/>	<input type="checkbox"/>
host	<input type="checkbox"/>	<input type="checkbox"/>	<input type="checkbox"/>	<input type="checkbox"/>	<input type="checkbox"/>	<input type="checkbox"/>	<input type="checkbox"/>	<input type="checkbox"/>
setvars	<input checked="" type="checkbox"/>	<input checked="" type="checkbox"/>	<input checked="" type="checkbox"/>	<input checked="" type="checkbox"/>	<input checked="" type="checkbox"/>	<input checked="" type="checkbox"/>	<input checked="" type="checkbox"/>	<input checked="" type="checkbox"/>
dynweb	<input type="checkbox"/>	<input type="checkbox"/>	<input type="checkbox"/>	<input type="checkbox"/>	<input type="checkbox"/>	<input type="checkbox"/>	<input type="checkbox"/>	<input type="checkbox"/>

Sensors

Alarms

Logging

Display

Config

Network

Monitoring

Diagnostics

Event Log

Admin

Help

PDA/Phone | XML | MIB

Version 1.0

21

Configuration Admin Tab

The user can set the system clock and administrative information on this tab. Additionally the user can set administrator and account passwords. See Unit Configuration section for details.

PANDUIT PVIQ POU 1 Networked PVIQ POU 1 Networked v3.5.6
 IP Address: 192.168.1.111 Local Time: Thu, 12/09/10 13:53:48 All is well: 1 Alarms monitored

Configuration

All Parameters

Reset ALL to Default Values ?
 Refresh DNS Cache

PVIQ POU 1 Networked Reset kWh

Reset Circuit A
 Reset Circuit B
 Reset Circuit C
 Reset all circuits

System Clock, set to GMT

Set Clock method: Manual - GMT

GMT to local, (+/-)hh:mm +00:00 *Make sure you are in GMT time zone*

Month	Day	Year	Hour	Minute	Second
12	09	10 (yy)	13 (0-23)	53 (0-59)	48 (0-59)

NTP primary server 192.43.244.18
 192.43.244.18

NTP secondary server 129.6.15.28
 129.6.15.28

Sync to NTP server period (seconds) 1800

Save Changes

Daylight Saving Time?

DST is DISABLED

Enable DST:

DST Start: in at

DST End: in at

Name and Password Configuration

NOTE 1: If Account currently has a password, leaving Old Password blank results in no changes to that account.
 NOTE 2: Administrator password may be used in the Old Password field of any account.
 NOTE 3: If setting New Password to blank, Account Name must also be blank.
 NOTE 4: If New Password is not blank, Account Name must not be blank.

Administrator Account Name:

Old Password:

New Password:

New Password Again: (again, to confirm)

Warning: Record your password. Loss of password may require 48 hours to recover.

Control Account Name:

Old Password:

New Password:

New Password Again: (again, to confirm)

Warning: Record your password. Loss of password may require 48 hours to recover.

View Only Account Name:

Old Password:

New Password:

New Password Again: (again, to confirm)

Warning: Record your password. Loss of password may require 48 hours to recover.

Admin Info

Contact Name:

Contact Email: (sysContact)

Contact Phone:

Device Location: (sysLocation)

Device Description: (sysName)

Saved Configuration XML File

XML File:

[Download Current XML File](#)

SSL Certificate and Private Key

SSL Certificate and Private Key are **INVALID**

SSL Certificate File:

SSL Private Key File:

Upload System Firmware

Firmware package file:

Firmware upload may take a few minutes. Please wait for response from browser.

Unit Configuration

Network Configuration

The unit's network configuration is set on the *Network* tab of the *Configuration* page. Settings pertaining to the unit's network connection are:

Network

Current Network Configuration set statically

Use **DHCP** for Network Configuration and DNS Server Addresses
 Use **DHCP** for Network Configuration and **Static** DNS server addresses:
 Use **Static** Network Configuration and DNS server addresses:

IP Address:

Subnet Mask:

Gateway:

Primary DNS Server:

Secondary DNS Server:

Web Server

Protocols:

HTTP Port:

HTTPS Port:

Telnet Service:

- **DHCP:** Allows the unit to request a dynamic IP address from a server on the network.
- **Static IP Address/Net Mask/Gateway:** When not using a dynamic address, enter static network configuration information here.
- **Telnet Service:** Enable or disable the built-in Telnet server.
- **HTTP Services:** Enables/disables access via HTTP and HTTPS. Available options are: HTTP and HTTPS, HTTP only, and HTTPS only. It is not possible to disable the web interface completely.
- **HTTP/HTTPS Server Port:** Changes the TCP port that each server listens on.
- **DNS Servers:** Allows the unit to resolve host names for Email, NTP and SNMP servers as well as cameras.

Time and Date

The system clock is set on the *Admin* tab of the *Configuration* page. The unit comes preconfigured with the IP addresses of two NIST time servers and is set to the Central Time Zone (-0500 GMT). Should a local time server be preferred, enter its IP address into the “NTP primary server” box and click the “Save Changes” button. Clearing the time server addresses and clicking “Save Changes” will set the time servers back to the defaults. The unit attempts to contact the time servers during boot up and periodically while running. Until a time server is contacted or the system clock is manually set, all log time stamps will present time as the number of seconds since the unit was powered up and graphs will not be shown.

System Clock, set to GMT

Set Clock method:

GMT to local, (+/-)hh:mm Make sure you are in GMT time zone

Month	Day	Year	Hour	Minute	Second
<input type="text" value="12"/>	<input type="text" value="09"/>	<input type="text" value="10"/> <small>(yy)</small>	<input type="text" value="13"/> <small>(0-23)</small>	<input type="text" value="57"/> <small>(0-59)</small>	<input type="text" value="42"/> <small>(0-59)</small>

NTP primary server
192.43.244.18

NTP secondary server
129.6.15.28

Sync to NTP server period (seconds)

The time, date, IP address and friendly name of the unit are displayed in the top of each web page.

PViQ POU 1 Networked

IP Address: 192.168.1.111
Local Time: Thu, 12/09/10 13:57:42

- ✓ The time and date are not adjusted for daylight savings time. Setting the time zone offset forward and backward an hour will cause a gap or overwriting of logs, respectively.

E-Mail

The unit is capable of sending e-mail to as many as five addresses at once. Most SMTP and ESMTP servers are compatible. Authentication options are None, POP3 (POP-before-SMTP) or ESMTP. The e-mail configuration is set on the *Monitoring* tab of the *Configuration* page.

E-mail

SMTP Server:

SMTP Port:

"From" E-mail Address:

Send alarms to this recipient:	Always	Business Hours?	After Hours?	SMS?
--------------------------------	--------	-----------------	--------------	------

To E-mail Address 1:

To E-mail Address 2:

To E-mail Address 3:

To E-mail Address 4:

To E-mail Address 5:

POP3 Server:

POP3 Port:

Username:

Password:

An SMTP server as well as “From” and “To” addresses are required to send e-mails. Some mail servers may require a username and password. In most cases, the username does not have to match the “From” address, but does need to be a valid user on the authenticating server. Microsoft Exchange servers will have to be set to allow SMTP relay from the IP address of the unit. In addition, a test email can be sent from the bottom of the *Monitoring* tab of the *Configuration* page.

Note: The unit cannot receive e-mails. The POP3 server is used strictly for authentication and is not required when using None or ESMTP.

Status Reports

When enabled, the unit will periodically send a full status report to all “To” e-mail addresses selected for the report. The report includes current unit data from all attached sensors as well as alarm states. Reporting frequency options are: weekly, hourly, every 2, 3, 4, 6, 8, 12, 24, or 48 hours. E-mail addresses are selected when the report is created by checking the corresponding e-mail destination box. Allowing the cursor to hover over an e-mail destination box will display the e-mail address that the box is associated with.

System Status E-Mail Reports?

Report Time: hour min
(0-23) (0-59)

Report Period:

E-mail Destinations:

Delete This Report:

SNMP

The unit supports retrieval of all data via Simple Network Management Protocol (SNMP) v1, v2c, and v3. In addition, alarm traps can be sent to up to two IP addresses. The SNMP configuration is entered on the *Monitoring* tab of the *Configuration* page.

SNMP

SNMP Service:

Read Community:

Listen port for GET:

Trap Community:

Write Community:

Trap Type:

Trap IP Address:port 1:
192.168.0.78

Trap IP Address:port 2:

Initial SNMPV3 data

Unauthenticated User:

Authenticated Manager:

Manager Authentication Password:

Manager Privacy Password:

Trap User:

Trap Authentication Password:

Trap Privacy Password:

Reset User/Access NVRAM will occur during the finish page.

The default community string is “public” and the MIB is downloadable via a link at the top of the unit’s web page.

Accounts and Passwords

The POU units offer account security options that are entered on the *Admin* tab of the *Configuration* page. There are three levels of account security:

- **Administrator:** Password protects the Display, Alarms and Configuration pages.
- **Control Access:** Password protects the Control Actions and Control Settings pages.
- **View-Only:** Password protects the Sensors, PDA, WAP and XML pages.

Name and Password Configuration

NOTE 1: If Account currently has a password, leaving Old Password blank results in no changes to that account.
 NOTE 2: Administrator password may be used in the Old Password field of any account.
 NOTE 3: If setting New Password to blank, Account Name must also be blank.
 NOTE 4: If New Password is not blank, Account Name must not be blank.

Administrator Account Name?

Old Password

New Password

New Password Again (again, to confirm)

Warning: Record your password. Loss of password may require 48 hours to recover.

Control Account Name?

Old Password

New Password

New Password Again (again, to confirm)

Warning: Record your password. Loss of password may require 48 hours to recover.

View Only Account Name?

Old Password

New Password

New Password Again (again, to confirm)

Warning: Record your password. Loss of password may require 48 hours to recover.

User account names may include alphanumeric characters, spaces and underscores. Passwords may include alphanumeric characters and underscores.

✓ **Note:** The Administrator account must be active to enable the Control Access and View-Only accounts.

✓ **Note:** The Control Access account must be active to enable the View-Only account.

✓ **Note:** The account names “root” and “admin” are disabled for security reasons and cannot be re-enabled.

 **Warning:** Record your passwords. To reset lost passwords, follow the instructions for resetting the unit’s IP address and passwords given in the Error! Reference source not found. action. To generate a temporary recovery password to access the unit, contact customer service from a location where the unit can be accessed via the internet.

Telnet

The unit provides a Telnet server for basic monitoring via the command line. The Administrator account must be enabled to use the Telnet interface. Type “help” after logging in to the unit to see a list of available commands. The Telnet service can be disabled under “Web Server” on the *Network* tab of the *Configuration* page.

✓ **Note:** All data sent via Telnet is unencrypted. Some settings can be changed and user names and network settings are available via Telnet. In secure environments, it is recommended that Telnet be disabled.

Camera Configuration

Enter the domain names/IP addresses and models of up to four IP-addressable network cameras in the “Cameras” section of the *Monitoring* tab on the *Configuration* page. The unit will present a linked snapshot from each camera on the *Sensors* page.

The screenshot shows a configuration window titled "Cameras". It contains four rows, each for a camera (Cam 1 to Cam 4). Each row has an "IP Address" text input field (all containing "0.0.0.0") and a "Model" dropdown menu (all set to "No camera"). A "Save Changes" button is located at the bottom right of the form.

Note: Each camera must be set to allow anonymous access to enable this feature.

Admin Information

Information entered in the “Admin Info” section of the *Admin* tab of the *Configuration* page will show up at the bottom of the unit’s web interface.

The screenshot shows a configuration window titled "Admin Info". It contains five rows of information: "Contact Name" (Panduit Corp.), "Contact Email" (SystemSupport@panduit.com) with "(sysContact)" next to it, "Contact Phone" (866-721-5302), "Device Location" (Test Lab A) with "(sysLocation)" next to it, and "Device Description" (POU 1 Networked) with "(sysName)" next to it. A "Save Changes" button is located at the bottom center of the form.

Kilowatt-Hours Reset

The unit's kilowatt-hours measurements are zeroed at the factory and can be reset at any time, should it become necessary. On the *Settings* tab of the *Control* page, simply hit the button that corresponds to the desired circuit to be reset.

XML File Backup

The POU unit's configuration is stored in the XML file. The XML file can be downloaded and stored in order to backup the POU unit's current configuration settings. On the *Admin* tab of the *Configuration* page, simply hit the Download Current XML File button to download the XML file.

A previously downloaded XML file can be uploaded to the POU unit in order to restore the unit's configuration to match the configuration contained in the XML file. On the *Admin* tab of the *Configuration* page, click the Upload Local XML file button to upload a local XML file.

✓ **Note:** XML files are unit specific. An XML file should only be uploaded to the unit that it was downloaded from.

SSL Certificate Upload

The POU will automatically generate a unique SSL Certificate and Private Key. Alternatively, a custom SSL Certificate and Private Key can be uploaded to the POU by pressing the Upload SSL Files button on the *Admin* tab of the *Configuration* page. The SSL Certificate and Private Key can be cleared by clicking the Erase SSL Data button on the *Admin* tab of the *Configuration* page.

Alarms

Alarm Notifications

The POU supports three types of alarm notification:

- **E-Mail:** The unit can be configured to send alarm e-mails to up to five recipients.
- **SNMP:** The unit can be configured to send SNMP traps to up to two trap servers.
- **Buzzer:** When a remote display is attached, the unit can turn on an audible alarm.

The unit is capable of any combination of the above alarms at once. Alarm type combinations are selected per alarm via the check boxes which are displayed for each alarm on the Alarms page.

Alarm Types

The POU provides three types of alarm messages via E-Mail and SNMP:

- **Trip:** Occurs when a sensor value goes above a high trip threshold or below a low trip threshold.
- **Clear:** Occurs when a sensor already in the Tripped or Unplugged state goes back into its normal range.
- **Unplugged:** Occurs when a sensor with an alarm set loses contact with the main unit due to the sensor being physically unplugged or another communications error.

Alarms can be added for each internal device or external sensor displayed on the Alarms page. An alarm is added by pressing the “Add New Alarm Button” and selecting the sensor value to be monitored from a drop down menu.

Thresholds

The user must set a trip threshold and type for each alarm that is added to the Alarms page. The threshold type is chosen as either “High Trip” or “Low Trip” from a drop down menu when the alarm is created. The threshold value is typed into a data window when the alarm is created. Alarms are triggered based on the selected sensor’s data and the trip threshold type and value. Alarm settings can be edited or deleted at any time.

Analysis of each unit is recommended before setting alarm thresholds as some of the values monitored by the unit are relative values, whose scale will differ slightly between units. Allow each unit to operate under normal, steady state conditions for several hours before setting alarm thresholds. By allowing the

sensors to operate for several hours, the user can better understand what the normal variations are; thereby allowing the user to choose alarm thresholds that will not trigger numerous false alarms.

✓ **Note:** Changes in settings take a few moments to become active. Rapidly resetting alarm values may not provide the desired results. Allow up to 2 minutes after changing a setting before modifying it again.

Sensors

Overview

All internal sensors are measured every 15 seconds. External sensors are measured every 15 to 30 seconds, depending on the number of devices connected. Sensor data collected by the unit gives useful trend analysis data. While all values are not absolute in relation to a known unit, trend analysis of the data allows users to view changes and draw useful conclusions about what is happening over time in the monitored environment.

Internal Sensors

The POU contains the following onboard sensors:

- **Kilowatt-Hours:** Cumulative sum of Real Power.
- **Volts:** Measures instantaneous RMS voltage.
- **Volts (Peak):** Reports the highest reported voltage since the last time the data was updated, typically every 15 seconds.
- **Amps:** Measures instantaneous RMS current.
- **Amps (Peak):** Reports the highest reported current since the last time the data on the screen was updated, typically every 15 seconds.
- **Real Power:** Average of instantaneous voltage and current over the last 1.5 seconds.
- **Apparent Power:** The product of instantaneous RMS Voltage and RMS Current. This is the value used by circuit breakers.
- **Power Factor:** The ratio of Real Power to Apparent Power.

Remote Sensors

Available Sensors

- **PVQ-EST-12: Environmental sensor:** Temperature
- **PVQ-ESTAFHD-12: Environmental sensor:** Temperature / Air Flow / Humidity / Dew Point

Please contact Panduit Technical Support if you need assistance locating your current version or upgrading to the new firmware version

Connecting Remote Sensors

Plug-and-play remote sensors may be attached to the unit at any time via the RJ-12 connectors on the face of the unit. In some cases splitters may be required to add additional sensors. Each sensor has a unique serial number and is automatically discovered and added to the web page. Up to sixteen sensors may be connected.

The display order of the sensors on the web page is determined by the serial number of each sensor. Friendly names for each sensor can be customized on the *Display* page.

✓ **Note:** The sensor uses Cat. 3 wire and RJ12 connectors. Wiring must be straight-through: reverse polarity will temporarily disable all sensors until corrected.

- ✓ **Note:** The sensors use a serial communication protocol and are subject to network signaling constraints dependent on shielding, environmental noise, and length of wire. Typical installations allow runs of up to 600 feet of sensor wire.

Data Logging and Display

All data collected by the unit can be graphed, except kilowatt-hours. The *Logging* page allows the user to select graphed content to be logged. Selected sensor values are logged into the data file at a rate of one point per minute and will be displayed on the optional Remote Display. The number of selected sensors determines the maximum data logging time span. This period is calculated and displayed on the *Logging* page. The oldest data will be deleted when the onboard memory fills up in order to make room for new data.

Accessories

Remote Display

This small module can be mounted in an accessible spot inside or outside the rack or cabinet. A backlit LCD display scrolls the values of items selected on the *Logging* page. The display is connected to the main unit via a 4-conductor handset-style cord. The display's onboard buzzer can be used in conjunction with E-Mail and SNMP to provide local alarming of error conditions. The buzzer can be silenced via the button on the face of the module; however the display's LED indicator will remain lit until the alarm condition is cleared.

IP-Addressable Network Cameras

The unit is able to interface with up to four IP-addressable network cameras. A live snapshot from each camera will be displayed on the unit's *Sensors* page underneath the main unit's graph. Clicking on a snapshot opens the camera's website in a new browser window.

Camera model and IP address are entered on the *Monitoring* tab of the *Configuration* page.

✓ **Note:** Some cameras require additional software downloads to display live video in a web browser.

Alternate Data Formats

In addition to the full access, control and configuration available via a desktop web browser, PViQ Networked and Environmental POU products present data in multiple formats for easy integration with other monitoring systems. Data formats available via links on the unit's web page are:



PDA/Phone |
XML | MIB

- **PDA/Phone:** Presents data in a format best-suited for PDA or cellular phone web browsers.
- **XML:** Extensible Markup Language. Presents data in a structured tree for use with automated scripts and monitoring systems.
- **MIB:** Management Information Base. Downloads the MIB for use with SNMP monitoring tools.

Service and Technical Support

Firmware Version

The firmware version is located in the upper right section of the web interface header, represented by v3.y.xx.

PViQ POU 1 Networked

IP Address: 192.168.1.111

Local Time: Thu, 12/09/10 14:11:43

PViQ POU 1 Networked v3.5.6

All is well: 1 Alarms monitored

Before contacting support, Panduit recommends the POU first be updated to the latest firmware version. If this is not possible, please have the existing firmware version number for the unit available when contacting technical support.

Firmware Updates

Keep your unit updated with the latest firmware releases or sign up for notifications. Contact Panduit Technical Support for information on updating your firmware, or visit the following website:

<http://www.panduit.com/Support/MNSTechSupport/index.htm>

Resetting POU

Should the POU lose communication, the processor may be manually rebooted without affecting power to the outlets. Pressing the 'Reset' button on the face of the unit will cause the processor to reboot. The web interface will remain off-line during boot up.

Service

No service or maintenance is required. Do not attempt to open the POU or you may void the warranty. No serviceable parts inside. Panduit recommends that power be removed from the unit before installing or removing any equipment.

Technical Support

For Technical Support on the PViQ POU please contact Panduit Technical Support using one of the following methods:

- 1-800-777-3300 (toll-free)
- cs@panduit.com
- <http://www.panduit.com/Support/MNSTechSupport/index.htm>