



# OptiCam 2 FS133 Termination Tool User Manual

**Release 1**

**Issue 2**

Copyright © 2019 Panduit Corp. All rights reserved. No part of this book shall be reproduced, stored in a retrieval system, or transmitted by any means, electronic, mechanical, photocopying, recording or otherwise, without written permission from Panduit. No patent liability is assumed with respect to the use of the information contained herein.

Although every precaution has been taken in the preparation of this book, Panduit assumes no responsibility for errors or omissions. Neither is any liability assumed for damages resulting from the use of the information contained herein.

---

# Table of Contents

---

<b>OptiCam 2 FS133 Termination Tool Overview</b> .....	<b>5</b>
<b>Safety Precautions</b> .....	<b>7</b>
Safety Glasses .....	7
Isopropyl Alcohol (92% or better) .....	7
Disposal of Bare Fibers .....	7
Laser Light .....	7
Cable Handling .....	8
<b>Tool Set Up</b> .....	<b>9</b>
<b>Component Identification</b> .....	<b>14</b>
<b>Buffer Stripping Steps</b> .....	<b>16</b>
250µm Coated Fiber Strip .....	16
900µm Tight-Buffered Fiber Strip .....	16
Jacketed Cable Strip .....	17
250µm Coated Fiber Termination Using OptiCom Fanout Kit .....	17
Buffer Stripping .....	18
<b>Cleave Fiber Steps</b> .....	<b>19</b>
Prep Stripped Fiber .....	19
Score & Cleave .....	19
<b>OptiCam 2 Tool Operation - LC</b> .....	<b>21</b>
Select Connector Options .....	21
Load Connector .....	21
Connector Test .....	22

Insert Cleaved Fiber .....	22
Cam Connector .....	23
Review Test Results .....	23
<b>Assemble Connector and Boot .....</b>	<b>25</b>
LC Connector and Boot .....	25
SC Connector and Boot .....	26
ST Connector and Boot .....	27
<b>Tool Care and Maintenance .....</b>	<b>28</b>
<b>Connect-It App Use .....</b>	<b>31</b>

# OptiCam 2 FS133 Termination Tool Overview



**WARNING** Read and understand the instructions and safety information in this manual before operating this tool. Failure to observe this warning can result in bodily injury.

**Warning:** Risk of fire. Battery can explode or leak and cause injury if installed backwards, disassembled, charged, crushed, or exposed to fire or high temperature.



**CAUTION** Caution - Use of controls or adjustments or performance of procedures other than those specified herein may result in hazardous radiation exposure. The laser is emitted from the LC connector located at the top of the tool. See the next page illustration for connector location.

- Never point the laser into the eyes of others.
- Do Not stare directly at the laser beam.
- Do Not set up tool to work at eye level or operate the tool on a reflective surface as the laser could be projected into your eyes or the eyes of others.

Viewing the laser output with certain optical instruments (for example, eye loupes, magnifiers, and microscopes) within a distance of 3.9" (99 mm) may pose an eye hazard.

Remove the batteries when storing for an extended period of time to avoid damage to the tool should the batteries deteriorate.

## Tool Storage

After all connector terminations are complete, detach the launch cord from the tool by disconnecting the LC connector at the top of the tool. Detach the ferrule adapter from the cradle and put dust caps on both ends of the launch cord. Place tool, launch cord, and cradle in a protective case.

## Tool Use

This tool is to be used for the termination of Panduit OptiCam connectors only. The tool emits a non-visible laser beam, which, when used in conjunction with the launch cord and cradle, aids in proper connector termination.

## Tool Care and Handling

- Laser tools are precision instruments, which should be handled with care. See Safety Precautions.
- Avoid shock, vibrations, and extreme heat.
- Avoid dust and water that could obstruct laser.
- Keep tool dry and clean.
- Check batteries regularly to avoid deterioration.
- Remove batteries if the tool is to be stored for an extended period.

## TECHNICAL INFORMATION

- **Recommended Use:** With available launch cords and cradles only
- **Laser Diode Type:** IEC 60825-1 Class 1 Laser product
- **Connectors:** LC, SC, ST, single mode and multimode, Panduit connectors only
- **Power Supply:** 2 size AA (type L91) 1.5volt Lithium Iron Disulfide batteries, Max Discharge: 2.5 amp continuous, included. Size AA alkaline batteries can be used at a reduced rate battery life. Tool can also be powered without batteries through the power/data (5 VDC, 1 amp max) port on the side of the tool.
- **Rated Battery Life:** Approximately 8 hours (continuous use)
- **Firmware Updates:** Use power/data port on the side of the tool to connect to PC, visit [www.panduit.com](http://www.panduit.com) for latest firmware
- **Environment:** FOR INDOOR USE ONLY, Max altitude 2000m, Pollution degree 2
- **Operating Temperature:** +32° F to +104° F (0° C to +40° C), <93% RH, non-condensing
- **Storage Temperature:** -40° F to +158° F (-40° C to +70° C)
- **Overall Dimensions:** 2.1" H x 2.8" W x 9.1" L (53mm x 71mm x 231mm)
- **Weight:** 9.0 oz (255 g) without batteries

- This tool contains no user-serviceable parts.
- The laser output is not adjustable.
- Contact Panduit Corp. for service needs.



## Do not Throw Away

This symbol indicates the need for separate collection of electrical and electronic equipment waste. Separating electronic waste can halt the potential adverse effects on the environment and human health as a result of the hazardous substances in electrical and electronic equipment. This waste should be returned to the proper collection facility.

## Compliance Symbols

Complies with IEC 60825-1 Ed. 3 (2014).

Complies with FDA performance standards for laser products except for deviations pursuant to Laser Notice No. 50, dated May 15, 2014.

This device complies with Part 15 of the FCC Rules. Operation is subject to the following two conditions:

(1) this device may not cause harmful interference, and (2) this device must accept any interference received, including any interference that may cause undesired operation.

La operación de este equipo está sujeta a las siguientes dos condiciones: (1) es posible que este equipo o dispositivo no cause interferencia perjudicial y (2) este equipo o dispositivo debe aceptar cualquier interferencia, incluyendo la que pueda causar su operación no deseada.

CAN ICES-3(B)/NMB-3(B)

**IMPORTANT: DO NOT** remove any labels from this tool.

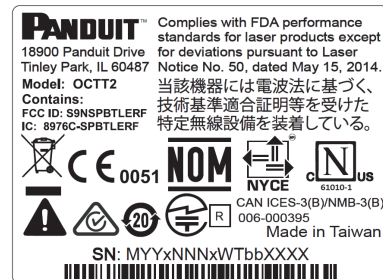
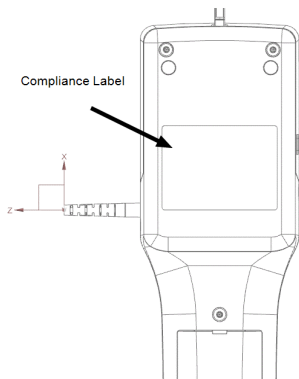

# Safety Precautions

## Safety Glasses

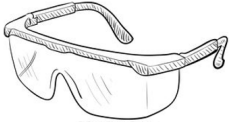

**WARNING:** It is strongly recommended that safety glasses be worn when handling bare optical fiber. The bare fiber is very sharp and can easily damage the eye.

## Isopropyl Alcohol (92% or better)

**WARNING:** Flammable.

Contact with alcohol can cause irritation to the eyes. In case of contact with eyes, flush with water for at least 15 minutes.

Always use alcohol with proper levels of ventilation.

In case of ingestion, consult a physician immediately.



## Disposal of Bare Fibers

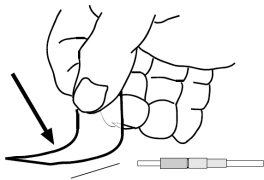

**WARNING:** Pick up and discard all pieces of bare fiber with sticky tabs. Do not let cut pieces of fiber stick to clothing or drop in the work area, where they are hard to see and can cause injury.

## Laser Light

**DO NOT VIEW DIRECTLY WITH OPTICAL INSTRUMENTS. CLASS 1M LASER PRODUCT.**

Viewing the laser output with certain optical instruments (for example, magnifiers and microscopes) within a distance of 100 mm may pose an eye hazard.

**CAUTION:** Use of controls of adjustments or performance of procedures other than those specified herein may result in hazardous radiation exposure.

- Never point the laser into the eyes of others
- Do not stare directly at the laser beam.

Do not set up tool to work at eye level or operate the tool on a reflective surface as the laser could be projected into your eyes, or the eyes of others.

## Cable Handling

**WARNING:** Fiber optic cable can be damaged by excessive pulling, twisting, crushing or bending stresses. Consult the appropriate specification sheets as provided by your cable vendor. Any damage may decrease optical performance.

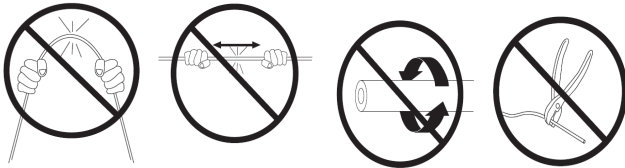

### To Ensure Best Termination

- Make sure the batteries are new and fresh.
- Make sure the launch cord is in good condition, the split sleeve is in good condition, and the ferrule end face is clean and not scratched.



# Tool Set Up

Various components of the OptiCam 2 Tool:

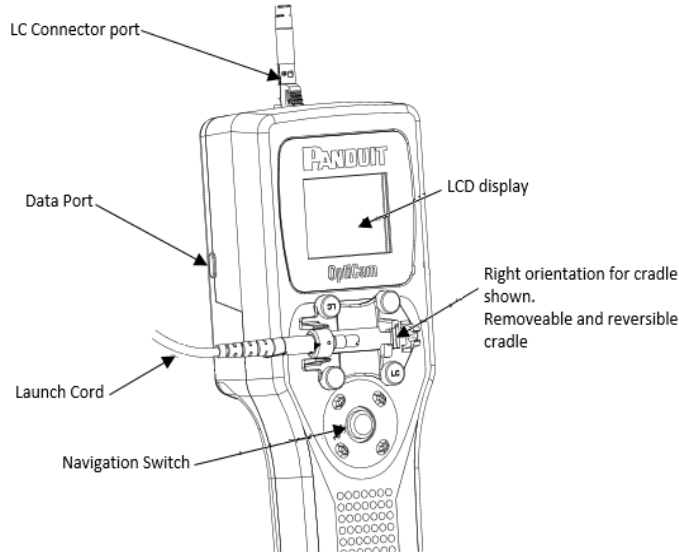

1. Select the proper Launch Cord and Cradle. For each connector type, select the correct launch cord and cradle for termination use.

## Connector Type, Launch Cord, and Cradle cross reference table

Connector Type	Launch Cord	Cradle*
LC single mode	yellow cable, 1.25mm single mode(P/N: FOLPC-1.25SM)	LC cradle, black (P/N: FLCC2)
LC multimode: OM1, OM2, OM3, and OM4	orange cable, 1.25mm multimode(P/N: FOLPC-1.25MM)	LC cradle, black (P/N: FLCC2)
SC single mode	yellow cable, 2.5mm single mode(P/N: FOLPC-2.5SM)	SC cradle, gray (P/N: FSICC2)
SC multimode: OM1, OM2, OM3, and OM4	orange cable, 2.5mm multimode(P/N: FOLPC-2.5MM)	SC cradle, gray (P/N: FSICC2)
ST single mode	yellow cable, 2.5mm single mode(P/N: FOLPC-2.5SM)	ST cradle, gray (P/N: FSTC2)
ST multimode: OM1, OM2, OM3, and OM4	orange cable, 2.5mm multimode(P/N: FOLPC-2.5MM)	ST cradle, gray (P/N: FSTC2)

\*Each cradle contains a marking to identify it as type LC, SC, or ST.

2. To load or replace batteries, remove the battery cover using a Phillips screwdriver.
3. Insert 2 size AA (type L91) 1.5volt Lithium Iron Disulfide batteries, follow the polarity markings in the compartment. Then replace the cover and secure it using the Phillips screw driver.



**Note:** The OptiCam 2 Tool does not charge batteries



**WARNING:** Risk of Fire. Battery can explode or leak and cause injury if installed backwards, disassembled, charged, crushed, or exposed to fire or high temperature.

4. The protective film on the Camera Aperture has a removal tab. The protective film on the LCD display can be removed by peeling from one corner.

**Note:** Remove the protective film from the Camera Aperture before operating the tool.



5. Before attaching the launch cord, first clean the launch cord on both ends. Refer to the Tool Care and Maintenance section of these instructions for proper technique.
6. Install the correct OptiCam 2 launch cord and OptiCam 2 cradle. An LC connector on the launch cord attaches to a port at the top of the tool, and the unique adapter attaches it to the cradle.

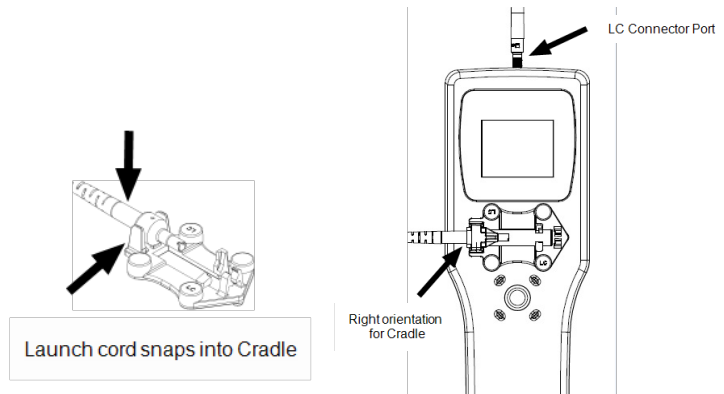

7. Please refer to the [Connector Type, Launch Cord, and Cradle Cross Reference Table](#) to make sure you are using the proper combination of cord, cradle, connector, and orientation.
8. When attaching the metal adapter to the cradle for LC terminations, the opening on the side of the barrel should be placed facing the tool.
9. The cradle attaches to the tool magnetically. Position the cradle onto the tool with either a left or right orientation, and the magnets will properly align the cradle. Right and left orientations are shown below (LC launch cord and LC Cradle are shown).

**Right Orientation for the cradle    Left Orientation for the cradle**

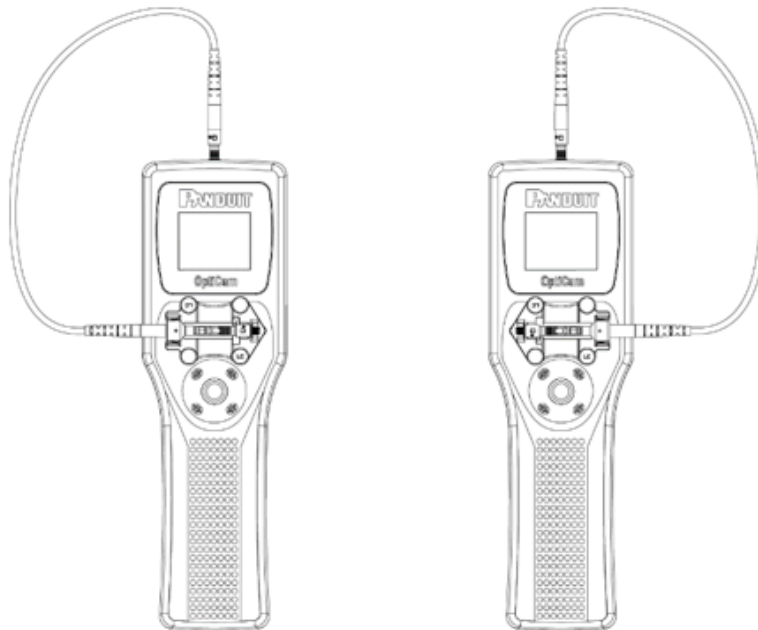

10. Power on by using the center of the navigation button. The first time the tool is powered on, the language will need to be selected.

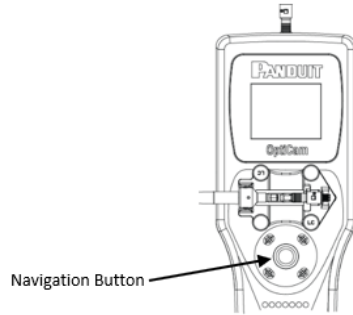

11. Use the navigation button to navigate to the menus and to **Connector Type** , and select the correct connector options:  
**Menu > Connector Type.**

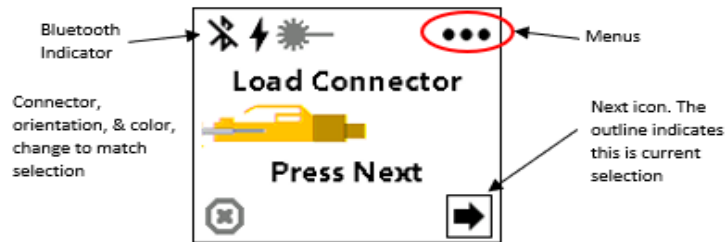

12. Use the navigation button to select the correct information. The selected text will become red. Click **Save**.

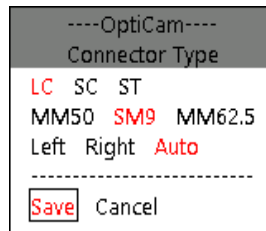

**Note:** To ensure proper function of the tool, check that settings on the tool match the cord, cradle, connector, and orientation being used.

13. To select the Insertion Loss (IL) Threshold, use the navigation button to navigate to the menus and to **Tool Settings**, then scroll down to **IL Threshold**. The settings window will allow you to select the desired threshold by moving the navigation button up and down and selecting **Save**, which will exit out of this topic.

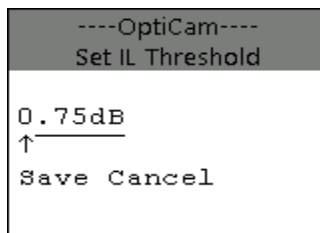

14. To load the connector, first clean the connector ferrule end face using Panduit's best practices for cleaning fiber components. LC and SC connector loading: A) Insert a connector while the launch cord is tilted up to receive the connector. B) Tilt the connector down and ensure the connector backbone snaps in to the cradle. *This image shows the new metal ferrule adapter for LC launch cords.*
15. To load an ST connector: A) Rotate the ST connector into the cradle. B) Rotate the retaining clip over the connector. C) Secure the clip with the audible "click". D) Place the launch cord on the connector end with the split sleeve attaching to the connector ferrule.

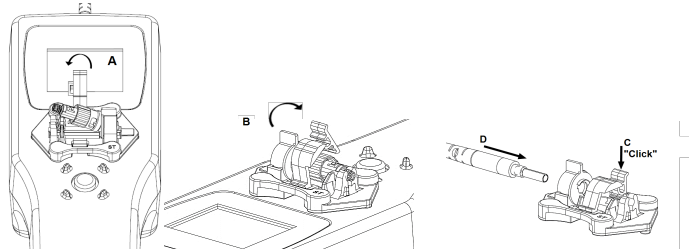
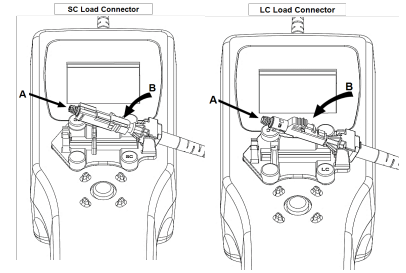

**Note: ST requires that the user hold the launch cord in place.**

16. The OptiCam 2 has a data port on the side of the tool which can be used to install firmware updates. The current version of the software on the tool can be determined in the System Menu on the tool.

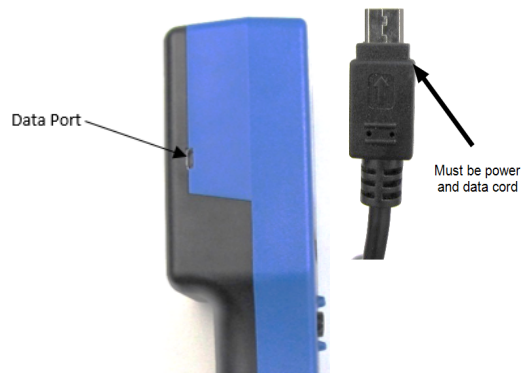

17. Update the tool to the most recent firmware available at [Panduit.com](http://Panduit.com) > **Support** > **Download Center** > **Software/Firmware/Printers** > **OptiCam 2 Termination Tool**.

# Component Identification

## LC Connectors, Launch Cord, and Cradle

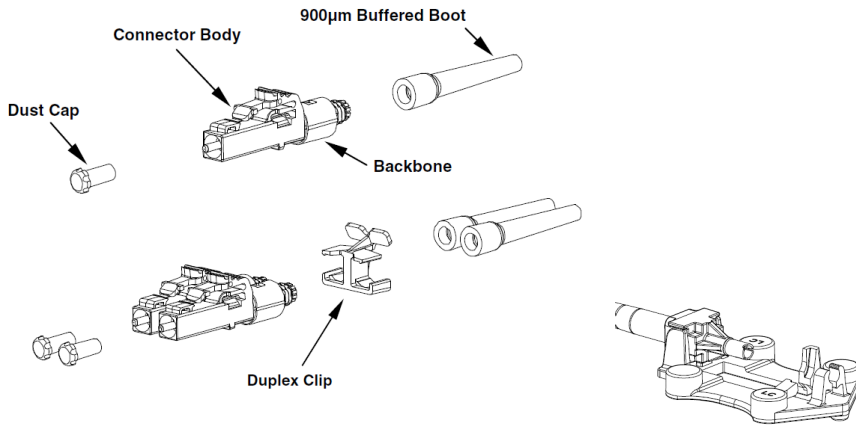

## SC Connectors, Launch Cord, and Cradle

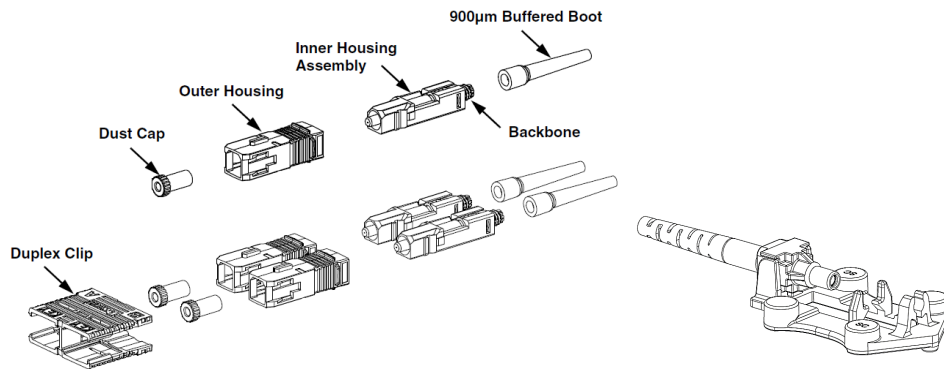

## ST Connectors, Launch Cord, and Cradle

Alignment Key must be in the alignment tab to cam properly. Additionally, the flat sides on the back bone will line up into the key slot of the cradle with the etched, rounded side facing down.

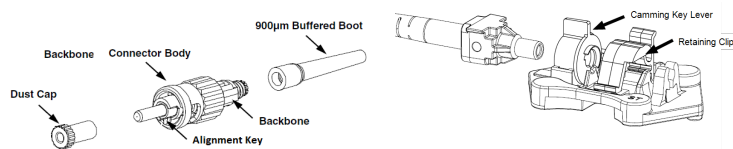

**Connector Types with Colors**

Fiber Type	Backbone Color (LC, SC)	Boot Color
OM3, OM4 (50µm)	Aqua	Aqua
OM2 (50µm)	Black	Black
OM1 (62.5µm)	Beige	Beige
OS1, OS2 (Single mode)	Blue	Blue

1.6 / 2.0mm Boot  
**FMCBT2AQ-X**  
**FMCBT2BL-X**  
**FSCBT2BU-X**

3.0mm Boot  
**FMCBT3AQ-X**  
**FMCBT3BL-X**  
**FSCBT3BU-X**

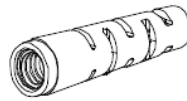
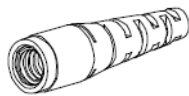

## Buffer Stripping Steps

### 250µm Coated Fiber Strip

1. Install the boot. Insert the fiber end through the small end of the boot. Slide the boot back out of the way.
2. Place one build-up tube (F250BT) onto the fiber and slide it back out of the way.
3. Place an insertion mark on the build-up tube at 0.59" (15mm) for LC and 0.43" (11mm) for SC/ST, from the end of the tube closest to the end of the fiber.
4. Use buffer stripper to strip at least 1.18" (30mm) of coating.
5. Place an insertion mark on the coated fiber 2" (51mm) from the end of the stripped coating.

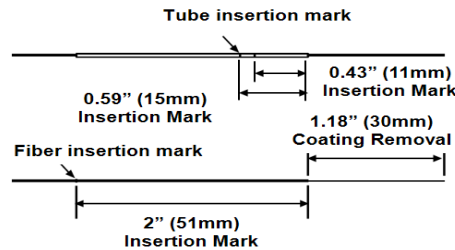
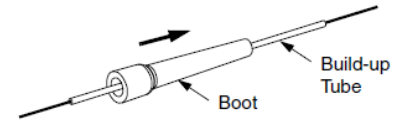

**IMPORTANT!** 250µm Coated Fiber Stripping Dimensions. Due to printing variations, use a rigid scale for stripping dimensions, or the appropriate Panduit laminated template.

6. Slide the leading edge of the build-up tube to the start of the coating after cleaving the fiber.

### 900µm Tight-Buffered Fiber Strip

1. Insert the fiber end through the small end of the 900µm boot. Slide the boot back out of the way.
2. Use buffer stripper to strip at least 1.18" (30mm) of buffer.
3. Use the marking pen to place an insertion mark at 0.59" (15mm) for LC and 0.43" (11mm) for SC/ST, back from the end of the stripped buffer.

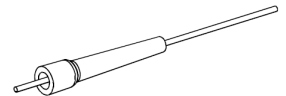

900µm TIGHT-BUFFERED STRIPPING DIMENSIONS

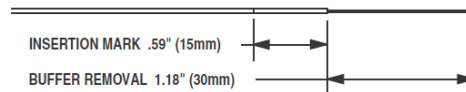

**IMPORTANT!** 900µm Coated Fiber Stripping Dimensions. Due to printing variations, use a rigid scale for stripping dimensions, or the appropriate Panduit laminated template.



## Jacketed Cable Strip

1. If using duplex cable, split the two cables approximately 6" (152mm) or as needed.
2. Following the stripping dimensions, use the marking pen to mark the cable jacket at 1.89" (48mm) for LC, and 1.73" (44mm) for SC/ST, from the end.
3. Strip off the cable at the jacket removal mark. To reduce wear on the jacket stripper blades, do not slide the blades along the aramid yarn. Instead, use the tool to cut through the jacket, then pull off the jacket by hand.

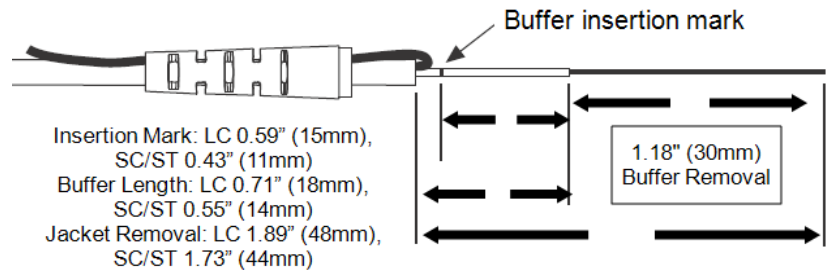

4. Insert the fiber through the small end of the appropriate boot for your specific cable type. Use the boot to fold the aramid yarn back over the jacket, holding it out of the way.
5. Use the marking pen to place a buffer length mark on the buffer at 0.71" (18mm) for LC, and 0.55" (14mm) for SC/ST, from the edge of the jacket. Place an insertion mark at 0.59" (15mm) for LC and 0.43" (11mm) for SC/ST, back from the first mark.

**IMPORTANT!** Due to printing variations, use a rigid scale for stripping dimensions, or the appropriate Panduit laminated template.

6. Use the marking pen to place a mark on the buffer at the edge of the jacket. This mark should remain at the edge of the jacket after buffer stripping.
7. Use the buffer stripper to strip the buffer to the buffer length mark.

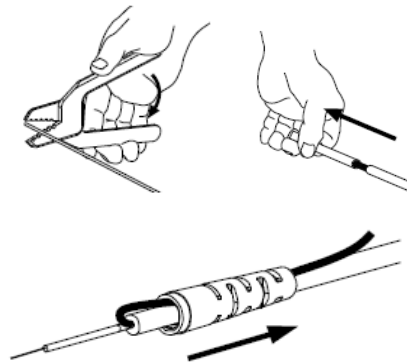

## 250µm Coated Fiber Termination Using OptiCom Fanout Kit

1. Install the Fanout Kit (FO6CB, FO12CB) according to the installation instructions FS047.
2. Feed the 250µm coated fibers through the 900µm fanout tubing until at least 30mm of fiber protrudes from the end of the tubing. Trim the coated fibers to length at 30mm.

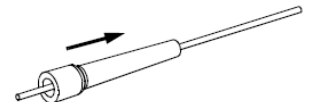

3. To reduce the amount of fiber movement, place a drop of adhesive (Loctite 401 or equivalent Cyanoacrylate adhesive) at the point that the coated fibers exit the 3mm cable jacket. 250µm coated fibers need to be taut between cable jacket and the fanout tube assembly.
4. Place the 900µm boots onto the fanout tubing and slide them back out of the way.
5. Place an insertion mark on the fanout tubing, at 0.59" (15mm) for LC and 0.43" (11mm) for SC/ST, back from the end of the tubing.

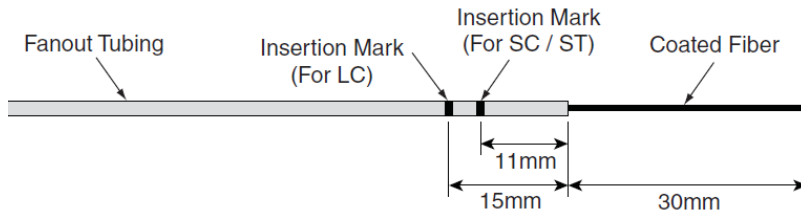
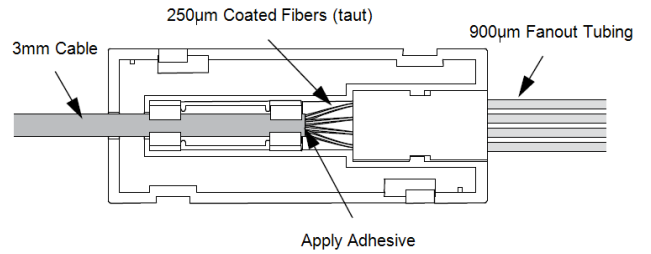

6. Place a coating removal mark on the coated fiber 3mm from the end of the fanout tubing. Strip the coating up to the coating removal mark. Note: The 3mm of coating extending from the end of the tubing is intended to compensate for fiber movement within the fanout tubing during termination.

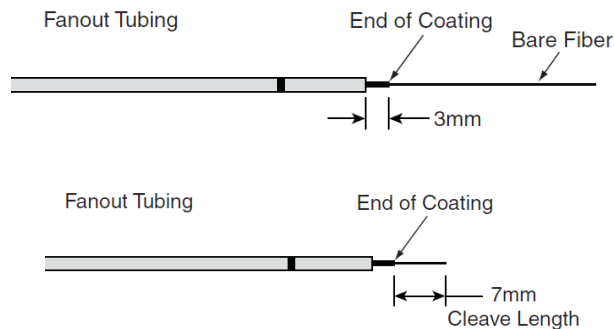

## Buffer Stripping

1. Remove no more than 1/4" (6mm) of buffer at a time to avoid breaking the fiber.
2. Hold the buffer stripper such that the tool is at a 90-degree angle to the fiber to ensure clean cut of buffer.
3. Position the fiber in the tool's V-notches. Squeeze the handles and pull toward the end of the fiber.

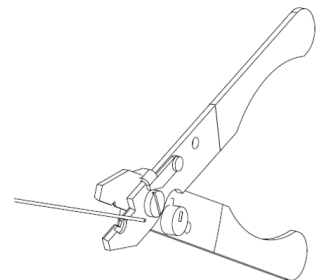

# Cleave Fiber Steps

## Prep Stripped Fiber

1. Remove and dispose of any remaining fiber scraps in the cleaving tool.
2. Clean bare fiber using an isopropyl alcohol (92% concentration) soaked lint-free wipe. The fiber should be free of all coating and residue. **To prevent contamination, do not set fiber down or allow it to touch anything after cleaning.**

3. Hold the cleaving tool in your hand and depress the fiber clamp lever to raise the fiber clamp. Insert the end of the fiber into the V-groove and under the fiber clamp. Release the fiber clamp lever when the end of the buffer is located at the 7mm mark ( $\pm 0.5\text{mm}$ ). This length is critical to termination.

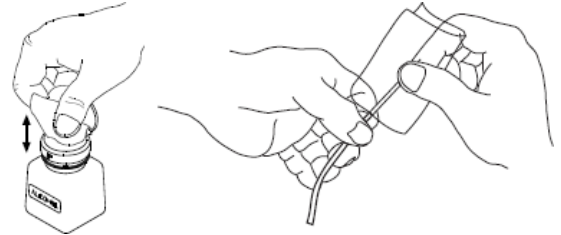
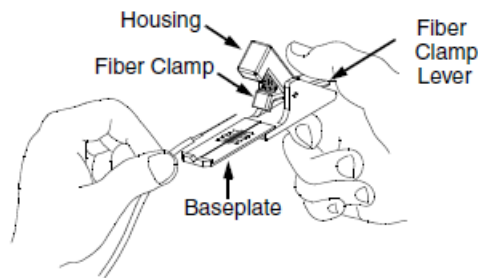

## Score & Cleave

1. **This is a critical step for successful termination.** Gently hold the buffered fiber against the groove in the base plate using thumb and forefinger of your free hand. With your other thumb, **gently** push down on the housing until the ceramic blade contacts the fiber only once. **DO NOT** cut the fiber with the ceramic blade. Release the housing so that the blade is no longer contacting the fiber.

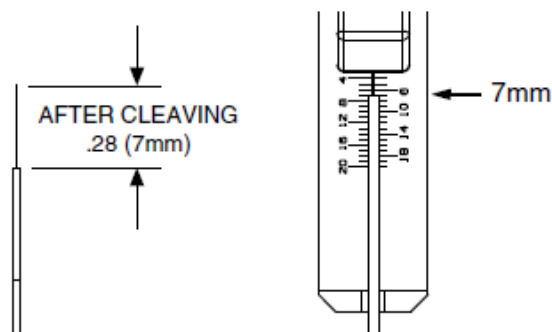

2. Hold the tool in one hand while still holding the fiber against the base plate. Bend the base plate down until the fiber breaks. **To prevent contamination, do not re-clean the fiber, do not set fiber down, or allow it to touch anything after cleaving.**



**IMPORTANT:** *Do not clean fiber after cleaving.* Replace the ceramic blade in the cleaving tool after every 1000 cleaves, or if installation yield decreases. Replacement blades (FJQCVRB) are available.

# OptiCam 2 Tool Operation - LC

## Select Connector Options

- Use the navigation button to navigate to the menus and to “Connector Type”, and select the correct connector options:  
**Menu > Connector Type.**

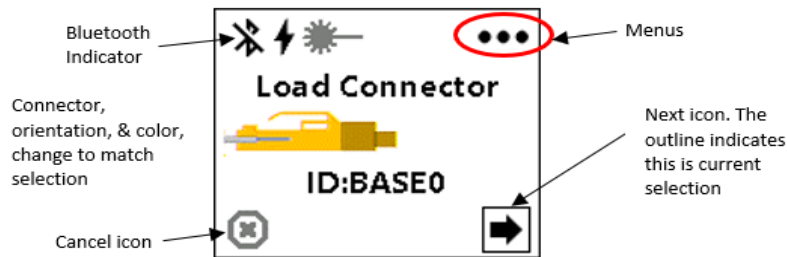

- Use the navigation button to select the correct information. The selected text will become red. Click **Save**.

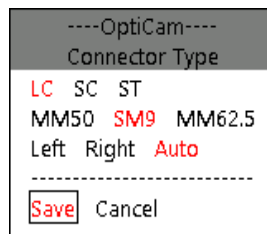

The orientation of the connector indicates the direction that the fiber is inserted from. If Auto is selected, the tool will determine this orientation automatically.

**Note:** To ensure proper function of the tool, check that settings on the tool match the cord, cradle, connector, and orientation being used.

## Load Connector

A) Insert a connector while the launch cord is tilted up to receive the connector. B) Tilt the connector down, ensure the connector backbone snaps in to the cradle.

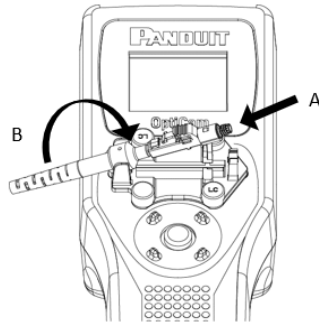

**Note:** Each connector has slightly different cradle operation. Refer to the individual connectors' specific instructions in the Tool Set Up section.

## Connector Test

To start the connector test, select the **Next** icon, pressing the navigation button directly down. The tool will perform a background test of the connector.

After passing the background test, the Insert Fiber command will display automatically.

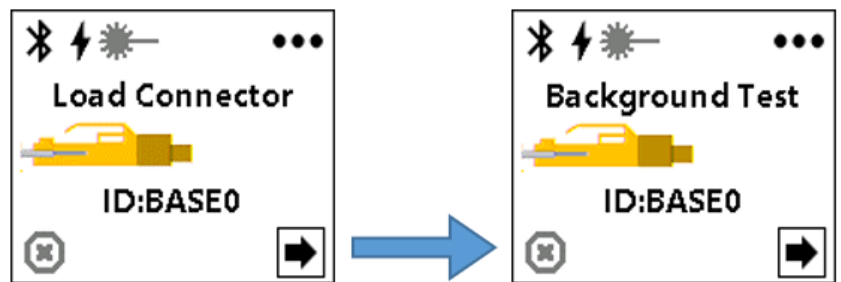

**Note:** While performing the steps it is important to avoid touching the connector except when camming the connector to get the best results from the tool.

## Insert Cleaved Fiber

Insert cleaved fiber and maintain gentle forward pressure while waiting for the CAM & Test command to appear on the screen.

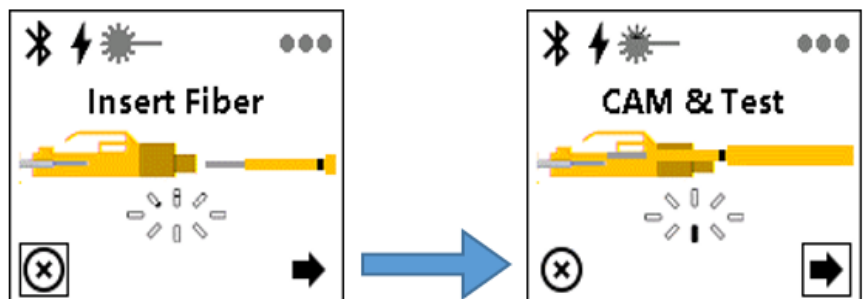

## Cam Connector

**LC Camming** requires that the whole connector rotate. When the screen displays the CAM & Test command, A) Maintain gentle forward pressure on the field fiber, and B) “Cam” the connector, then select the **Next** arrow to perform the test.

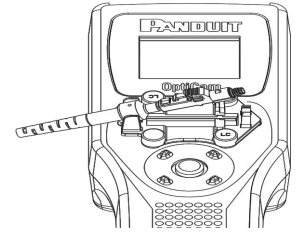

**SC Camming** requires that the key “Fin” rotates, and the rest of the connector remains in place.

**Note:** This image shows the new metal ferrule adapter for LC launch cords.

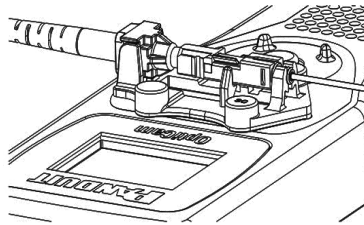

Detail A

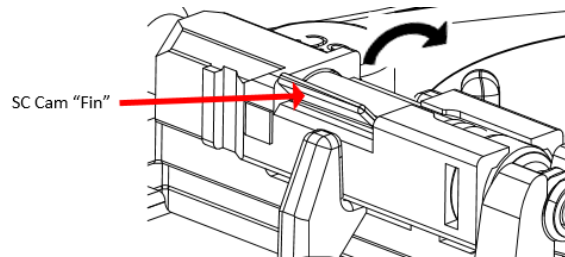

## ST Camming

ST Camming is done by rotating the key lever of the cradle, which engages the internal camming parts of the connector.

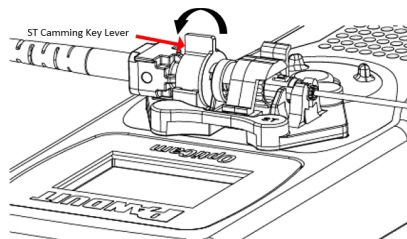

## Review Test Results

Verify that the IL value meets project requirements.

If the IL does not meet your project requirements, select the cancel icon and repeat the fiber termination process for that connector ID. Selecting forward advances the connector ID number for the tool to do another termination. In both cases, the results will be recorded in the tool for later retrieval. The OptiCam connector can be reused up to three times.

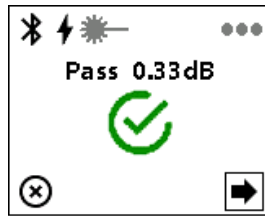



# Assemble Connector and Boot

## LC Connector and Boot

1. Grip the boot by the large end and push the boot forward onto the grooved area of the backbone until it is against the flange. The insertion mark should be at the end of backbone.

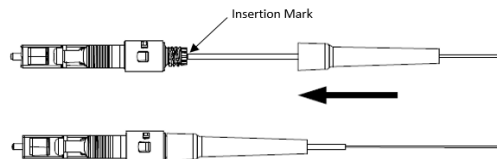

2. Clean the ferrule end face with an alcohol soaked wipe and then a dry wipe. Place the dust cap over the ferrule end.

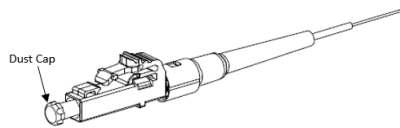

3. (**Optional**) With a connector held as shown (latch on top, ferrule facing away), insert the connector into one side of the duplex clip as shown (clip held with the "A->B" polarity marking upright and facing forward). The upper tab of the clip should slide into the pocket underneath the latch of the connector, and the lower tab should slide under the connector housing and "snap", locking it into place.

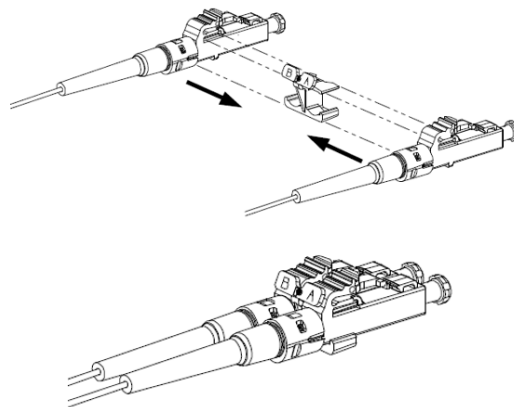

Repeat this procedure for the other connector, completing the duplexing step.

**Note:** When making cable assemblies, be sure to follow the correct "A->B" polarity cross-over between connectors.

## SC Connector and Boot

1. Grip the boot by the large end and push the boot forward onto the grooved area of the backbone until it is against the flange. The insertion mark should be at end of backbone.
2. Align the external chamfers on the front of the inner housing assembly with the internal chamfers at the front of the outer housing.
3. Push the inner housing assembly into the outer housing until it snaps into place. Once in place the outer housing should be able to move freely back and forth over the inner housing and boot.
4. The connector can be re-terminated if needed. Make sure that the dust cap is on the ferrule. Grip the outer housing and push the connector tip down onto a hard surface. The inner housing will release from the outer housing. Remove outer housing. Slide the boot off the backbone. Un-cam the connector and remove the fiber.

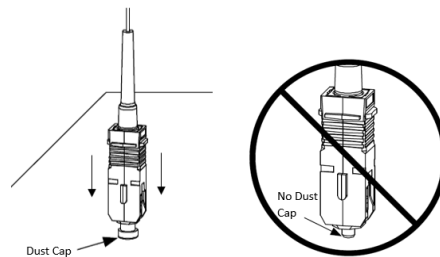
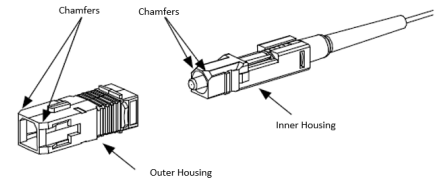

**CAUTION:** DO NOT push down without a dust cap installed on the ferrule. Doing so could damage the pre-polished fiber end face.

5. Clean the ferrule end face with a dry wipe. Place the dust cap over the ferrule end.

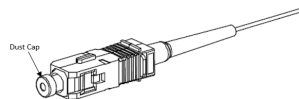

6. **(Optional)** Orient the connector as shown with the connector key facing upward in the same direction as the 'A', 'B' and 'KEY' markings on the duplex clip. Insert the connector into one side of the clip on a slight angle and rotate into place. The upper and lower legs of the clip slide over the connector and "snap" when the connector is in place. The connector is fully seated once the top and bottom connector flanges are inside of the rectangular slots in the clip.

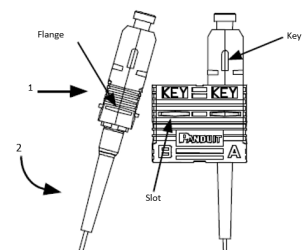

Repeat this procedure for the other connector, completing the duplexing step.

**Note:** When making cable assemblies, be sure to follow the correct 'A->B' polarity cross-over between connectors.

## ST Connector and Boot

1. Grip the boot by the large end and push the boot forward onto the grooved area of the backbone until it is against the flange. The insertion mark should be at end of backbone.

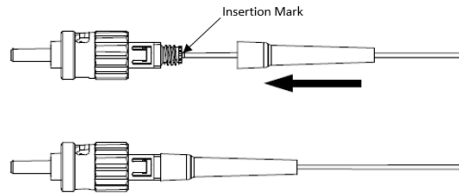

2. Clean the ferrule end face with a dry wipe. Place the dust cap over the ferrule end.

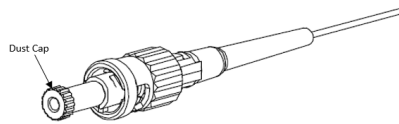

3. Slide the boot back to release the aramid yarn. Cut the aramid yarn approximately 0.20" (5mm) past the flange. Flare the aramid yarn evenly around the perimeter of the grooved area of the backbone. Use tweezers for best results. There will be a slight gap between the cable jacket and the backbone. Push the boot forward and thread clockwise onto the grooved area of the backbone until it seats against the flange. Best cable retention is achieved when the aramid yarn protrudes slightly from the flange area.

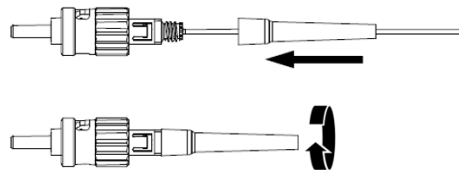

## Tool Care and Maintenance

1. The LC connector port and data port protective dust caps must be installed when the tool is not in use to prevent contamination.
2. The camera aperture should be cleaned periodically with a soft, lint free cloth or with isopropyl alcohol to remove dust and debris which may interfere with proper camera operation. Avoid any scratches on the surface. The LC connector port can be cleaned with clean dry air. Do not use alcohol.
3. The dust caps for both the LC connector (tool end) and the Ferrule Adapter (field connector end) must be installed when the cord is not in use. Do not coil the cable to less than one-inch diameter at any time to avoid damaging the fiber.

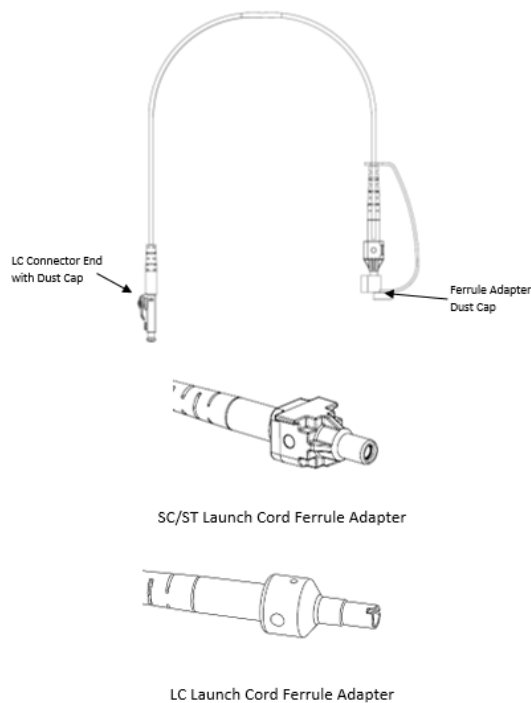

4. The fiber tip of the launch cords should be cleaned every 50 connector terminations. To clean, retract the boot to expose the cable crimp sleeve. Remove the Ferrule Adapter by holding the crimp sleeve and unthreading from the Ferrule Adapter Assembly to expose the white ceramic split sleeve.

Plastic and Metal Ferrule Adapter

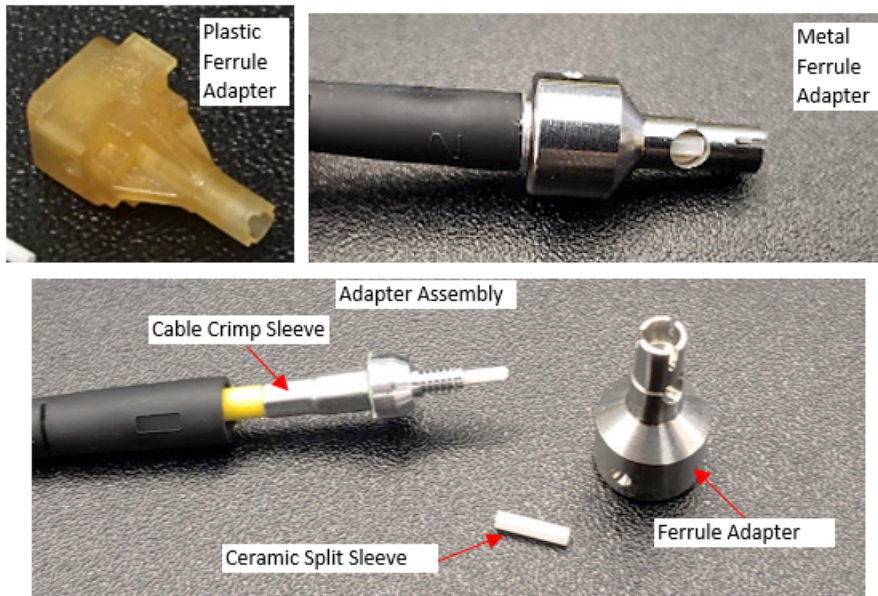

**Note:** 1.25 millimeter cord is shown for reference. The process is the same for the 2.5 millimeter cord.

- Twist the split sleeve and pull to remove it from the assembly, exposing the tip of the fiber.

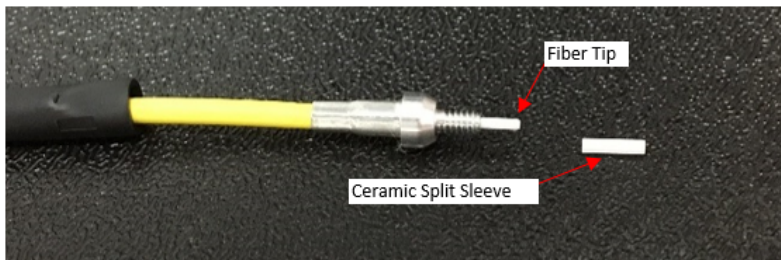

- Wet an area of the fiber optic cleaning system wipes with fiber optic cleaning solution.



- Clean the ferrule end faces of any connector or launch cord end, using a dry lint-free wipe.



8. If there is stubborn debris on the ends after dry cleaning, use this method: Using the cleaning solution, moisten one end of a row on the cleaning box. Drag the tip of the fiber along the fiber cleaning row (example shown in blue) from the wet area to the dry area. Then repeat the wiping procedure with a dry row (example shown in red).

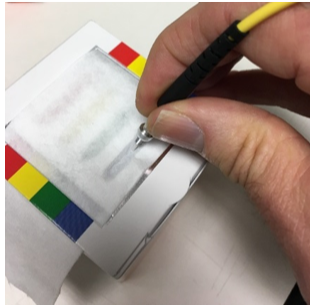

9. To reassemble the Ferrule Adapter, first inspect the split sleeve for chipping or cracks. Thread the Ferrule Adapter onto the Ferrule Adapter Assembly until the parts make contact. Hold the Cable Crimp Sleeve and turn the Ferrule Adapter about 5° to tighten the adapter.

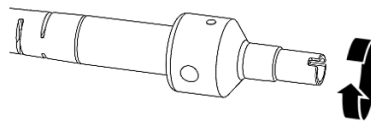

10. Always clean the LC connector end of the launch cord before inserting the connector into the tool. Remove the dust cap and wipe the end face of the fiber, using the same wet/dry procedure. Insert the connector into the tool immediately after cleaning.

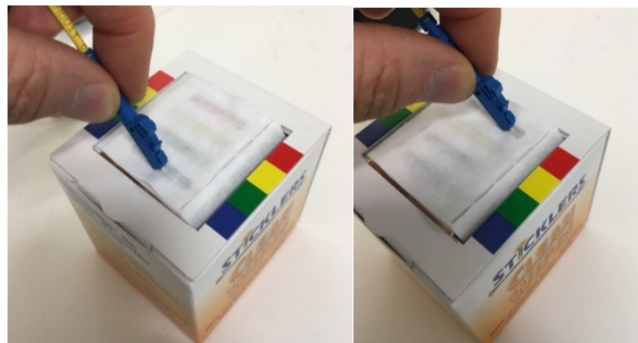

# Connect-It App Use

## Connect-It

### App Overview

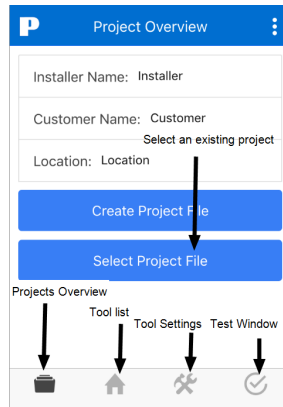

1. Navigate to the menus of the OptiCam 2 tool and select: **Tool Settings > Wireless > On**. Then select **Exit**.
2. Enter the wireless password given when registering the tool at Panduit.com.
3. Turn wireless on.

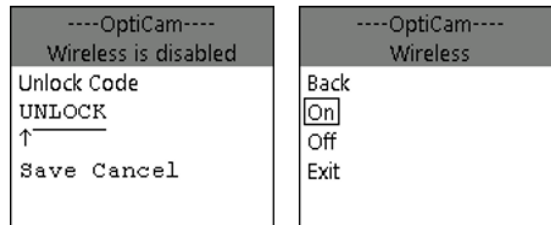

**Note:** The tool name is found under **Menus > Tool Settings > Tool Name**. Rename for ease of use.

4. To create a new project in Connect-It app, enter the project credentials, and then select **Create Project File**.

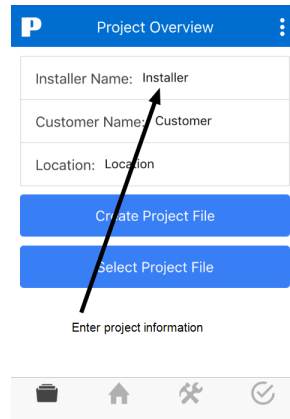

5. Connect to the OptiCam 2 tool by pulling down to refresh the list and selecting the appropriate tool name from the list. Then select **Start Project**.

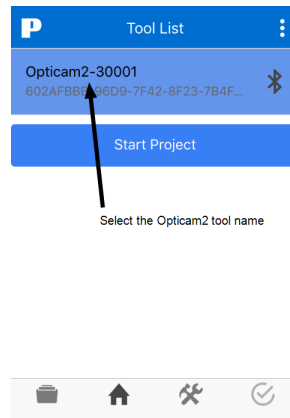

6. The app will indicate that the tool has un-synced records if terminations were done on the tool without the app and tool being synced. Select **OK** to sync. This transfers the records of the termination(s) to the project file in the app.

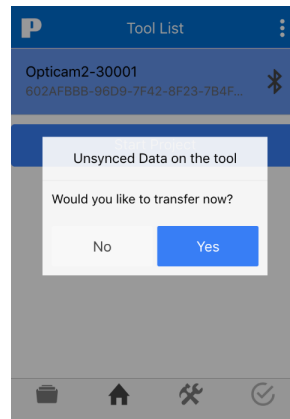

**Note:** The records will no longer be available on the OptiCam 2 tool.



7. To export the connector termination data, navigate to the “Project Overview” and select the current project. There are three available options:
  - a. **Share** – enables the file to be emailed;
  - b. **Select** – opens the file;
  - c. **Delete** – deletes the file from the app.
8. To share, select the **Share** option. Your mobile device’s default email will open with a CSV attachment containing the connector data.

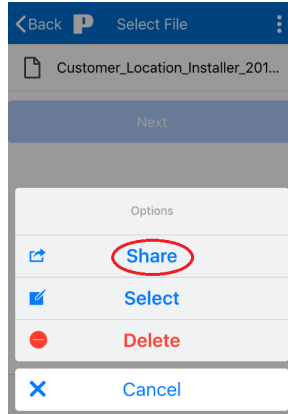

9. While the mobile app is connected to the OptiCam 2 tool, open a previous project or create a new project. Verify the tool settings and connector settings on the **Tool Settings** tab.
10. Properly set the IL threshold with the drop-down menu.

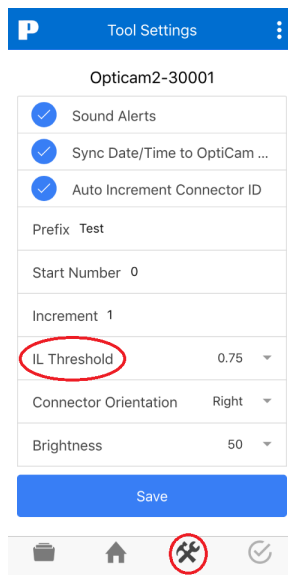

11. Select the **Test Window** tab.

12. Verify the connector type in the Test Window, and then install the connector into the cradle and select Load Connector. The tool will perform a Background Test and automatically display Insert Fiber.

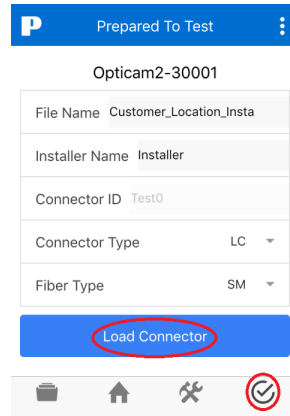

13. Insert the fiber into the connector. When the fiber is fully inserted, the graphic on the tool will change to Cam & Test.

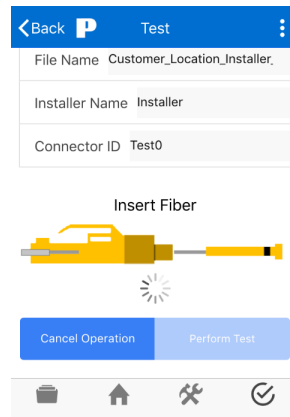

14. Cam the connector per the connector style of camming, and maintain pressure on the field fiber at the same time.
15. Select **Perform Test** on the app.

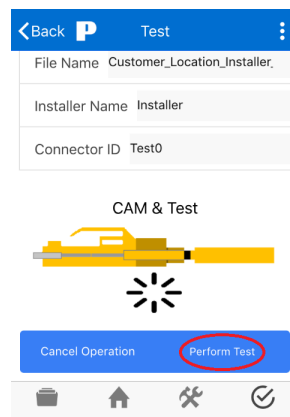

16. The test result will display. Verify that the IL value meets project requirements.

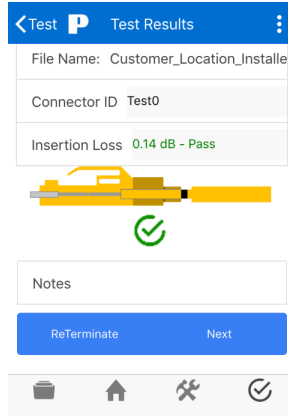

17. If needed, re-test by using the **Re-test** icon, or re-terminate using the **ReTerminate** icon and repeat the fiber clean and cleave steps. The OptiCam connector can be reused up to three times.
18. To export the connector termination data, navigate to the “Project Overview” and select the current project. There are three available options:
  - a. **Share** – enables the file to be emailed;
  - b. **Select** – opens the file;
  - c. **Delete** – deletes the file from the app.
19. To share select the **Share** option. Your mobile device’s default email will open with a CSV attachment containing the connector data.

